



# Intel® Architecture Optimization

---

*Reference Manual*

Copyright © 1998, 1999 Intel Corporation  
All Rights Reserved  
Issued in U.S.A.  
Order Number: 245127-001



# *Intel® Architecture Optimization Reference Manual*

---

Order Number: 730795-001

---

<b>Revision</b>	<b>Revision History</b>	<b>Date</b>
001	Documents Streaming SIMD Extensions optimization techniques for Pentium® II and Pentium III processors.	02/99

---

Information in this document is provided in connection with Intel products. No license, express or implied, by estoppel or otherwise, to any intellectual property rights is granted by this document. Except as provided in Intel's Terms and Conditions of Sale for such products, Intel assumes no liability whatsoever, and Intel disclaims any express or implied warranty, relating to sale and/or use of Intel products including liability or warranties relating to fitness for a particular purpose, merchantability, or infringement of any patent, copyright or other intellectual property right. Intel products are not intended for use in medical, life saving, or life sustaining applications.

This Intel® Architecture Optimization manual as well as the software described in it is furnished under license and may only be used or copied in accordance with the terms of the license. The information in this manual is furnished for informational use only, is subject to change without notice, and should not be construed as a commitment by Intel Corporation. Intel Corporation assumes no responsibility or liability for any errors or inaccuracies that may appear in this document or any software that may be provided in association with this document.

Except as permitted by such license, no part of this document may be reproduced, stored in a retrieval system, or transmitted in any form or by any means without the express written consent of Intel Corporation.

Intel may make changes to specifications and product descriptions at any time, without notice.

\* Third-party brands and names are the property of their respective owners.

Copyright © Intel Corporation 1998, 1999.

# Contents

---

## Introduction

Tuning Your Application .....	xvii
About This Manual.....	xviii
Related Documentation .....	xix
Notational Conventions.....	xx

## Chapter 1 Processor Architecture Overview

The Processors' Execution Architecture.....	1-1
The Pentium® II and Pentium III Processors Pipeline.....	1-2
The In-order Issue Front End .....	1-2
The Out-of-order Core.....	1-3
In-Order Retirement Unit.....	1-3
Front-End Pipeline Detail .....	1-4
Instruction Prefetcher .....	1-4
Decoders.....	1-4
Branch Prediction Overview .....	1-5
Dynamic Prediction .....	1-6
Static Prediction .....	1-6
Execution Core Detail .....	1-7
Execution Units and Ports .....	1-9
Caches of the Pentium II and Pentium III Processors.....	1-10
Store Buffers .....	1-11

Streaming SIMD Extensions of the Pentium III Processor...	1-12
Single-Instruction, Multiple-Data (SIMD).....	1-13
New Data Types .....	1-13
Streaming SIMD Extensions Registers.....	1-14
MMX™ Technology.....	1-15

## **Chapter 2 General Optimization Guidelines**

Integer Coding Guidelines .....	2-1
Branch Prediction .....	2-2
Dynamic Branch Prediction.....	2-2
Static Prediction .....	2-3
Eliminating and Reducing the Number of Branches .....	2-5
Performance Tuning Tip for Branch Prediction.....	2-8
Partial Register Stalls .....	2-8
Performance Tuning Tip for Partial Stalls .....	2-10
Alignment Rules and Guidelines.....	2-11
Code .....	2-11
Data .....	2-12
Data Cache Unit (DCU) Split.....	2-12
Performance Tuning Tip for Misaligned Accesses.....	2-13
Instruction Scheduling .....	2-14
Scheduling Rules for Pentium II and Pentium III Processors.....	2-14
Prefixed Opcodes.....	2-16
Performance Tuning Tip for Instruction Scheduling.....	2-16
Instruction Selection .....	2-16
The Use of lea Instruction .....	2-17
Complex Instructions .....	2-17
Short Opcodes .....	2-17
8/16-bit Operands .....	2-18
Comparing Register Values .....	2-19
Address Calculations .....	2-19

Clearing a Register.....	2-19
Integer Divide .....	2-20
Comparing with Immediate Zero .....	2-20
Prolog Sequences .....	2-20
Epilog Sequences .....	2-20
Improving the Performance of Floating-point Applications .....	2-20
Guidelines for Optimizing Floating-point Code .....	2-21
Improving Parallelism .....	2-21
Rules and Regulations of the fxch Instruction .....	2-23
Memory Operands.....	2-24
Memory Access Stall Information.....	2-24
Floating-point to Integer Conversion .....	2-25
Loop Unrolling .....	2-28
Floating-Point Stalls.....	2-29
Hiding the One-Clock Latency of a Floating-Point Store .....	2-29
Integer and Floating-point Multiply.....	2-30
Floating-point Operations with Integer Operands .....	2-30
FSTSW Instructions.....	2-31
Transcendental Functions.....	2-31

### Chapter 3 Coding for SIMD Architectures

Checking for Processor Support of Streaming SIMD Extensions and MMX Technology.....	3-2
Checking for MMX Technology Support .....	3-2
Checking for Streaming SIMD Extensions Support.....	3-3
Considerations for Code Conversion to SIMD Programming .....	3-4
Identifying Hotspots.....	3-6
Determine If Code Benefits by Conversion to Streaming SIMD Extensions .....	3-7
Coding Techniques.....	3-7

Coding Methodologies .....	3-8
Assembly .....	3-10
Intrinsics .....	3-11
Classes .....	3-12
Automatic Vectorization .....	3-13
Stack and Data Alignment .....	3-15
Alignment of Data Access Patterns .....	3-15
Stack Alignment For Streaming SIMD Extensions .....	3-16
Data Alignment for MMX Technology .....	3-17
Data Alignment for Streaming SIMD Extensions .....	3-18
Compiler-Supported Alignment .....	3-18
Improving Memory Utilization .....	3-20
Data Structure Layout .....	3-21
Strip Mining .....	3-23
Loop Blocking .....	3-25
Tuning the Final Application .....	3-28

## **Chapter 4 Using SIMD Integer Instructions**

General Rules on SIMD Integer Code .....	4-1
Planning Considerations .....	4-2
CPUID Usage for Detection of Pentium III Processor	
SIMD Integer Instructions .....	4-2
Using SIMD Integer, Floating-Point, and MMX Technology	
Instructions .....	4-2
Using the EMMS Instruction .....	4-3
Guidelines for Using EMMS Instruction .....	4-5
Data Alignment .....	4-6
SIMD Integer and SIMD Floating-point Instructions .....	4-6
SIMD Instruction Port Assignments .....	4-7
Coding Techniques for MMX Technology SIMD Integer	
Instructions .....	4-7
Unsigned Unpack .....	4-8
Signed Unpack .....	4-8



---

Interleaved Pack without Saturation .....	4-11
Non-Interleaved Unpack.....	4-12
Complex Multiply by a Constant .....	4-14
Absolute Difference of Unsigned Numbers .....	4-14
Absolute Difference of Signed Numbers .....	4-15
Absolute Value.....	4-17
Clipping to an Arbitrary Signed Range [high, low].....	4-17
Clipping to an Arbitrary Unsigned Range [high, low] .....	4-19
Generating Constants.....	4-20
Coding Techniques for Integer Streaming SIMD	
Extensions .....	4-21
Extract Word.....	4-22
Insert Word.....	4-22
Packed Signed Integer Word Maximum .....	4-23
Packed Unsigned Integer Byte Maximum.....	4-23
Packed Signed Integer Word Minimum .....	4-23
Packed Unsigned Integer Byte Minimum.....	4-24
Move Byte Mask to Integer.....	4-24
Packed Multiply High Unsigned .....	4-25
Packed Shuffle Word .....	4-25
Packed Sum of Absolute Differences .....	4-26
Packed Average (Byte/Word).....	4-27
Memory Optimizations .....	4-27
Partial Memory Accesses.....	4-28
Instruction Selection to Reduce Memory Access Hits....	4-30
Increasing Bandwidth of Memory Fills and Video Fills ...	4-32
Increasing Memory Bandwidth Using the MOVQ Instruction.....	4-32
Increasing Memory Bandwidth by Loading and Storing to and from the Same DRAM Page.....	4-32
Increasing the Memory Fill Bandwidth by Using Aligned Stores .....	4-33

Use 64-Bit Stores to Increase the Bandwidth to Video.....	4-33
Increase the Bandwidth to Video Using Aligned Stores.....	4-33
Scheduling for the SIMD Integer Instructions .....	4-34
Scheduling Rules .....	4-34

## **Chapter 5 Optimizing Floating-point Applications**

Rules and Suggestions.....	5-1
Planning Considerations.....	5-2
Which Part of the Code Benefits from SIMD Floating-point Instructions? .....	5-3
MMX Technology and Streaming SIMD Extensions Floating-point Code .....	5-3
Scalar Code Optimization .....	5-3
EMMS Instruction Usage Guidelines .....	5-4
CPUID Usage for Detection of SIMD Floating-point Support.....	5-5
Data Alignment .....	5-5
Data Arrangement.....	5-6
Vertical versus Horizontal Computation .....	5-6
Data Swizzling.....	5-10
Data Deswizzling.....	5-13
Using MMX Technology Code for Copy or Shuffling Functions .....	5-17
Horizontal ADD .....	5-18
Scheduling .....	5-22
Scheduling with the Triple-Quadruple Rule.....	5-24
Modulo Scheduling (or Software Pipelining) .....	5-25
Scheduling to Avoid Register Allocation Stalls.....	5-31
Forwarding from Stores to Loads.....	5-31
Conditional Moves and Port Balancing.....	5-31
Conditional Moves.....	5-31

---

Port Balancing .....	5-33
Streaming SIMD Extension Numeric Exceptions .....	5-36
Exception Priority .....	5-37
Automatic Masked Exception Handling .....	5-38
Software Exception Handling - Unmasked Exceptions ..	5-39
Interaction with x87 Numeric Exceptions .....	5-41
Use of <code>CVTTSS2PI/CVTTSS2SI</code> Instructions .....	5-42
Flush-to-Zero Mode .....	5-42

## **Chapter 6 Optimizing Cache Utilization for Pentium III Processors**

Prefetch and Cacheability Instructions .....	6-2
The Prefetching Concept .....	6-2
The Prefetch Instructions .....	6-3
Prefetch and Load Instructions .....	6-4
The Non-temporal Store Instructions .....	6-5
The sfence Instruction .....	6-6
Streaming Non-temporal Stores .....	6-6
Coherent Requests .....	6-8
Non-coherent Requests .....	6-8
Other Cacheability Control Instructions .....	6-9
Memory Optimization Using Prefetch .....	6-10
Prefetching Usage Checklist .....	6-12
Prefetch Scheduling Distance .....	6-12
Prefetch Concatenation .....	6-13
Minimize Number of Prefetches .....	6-15
Mix Prefetch with Computation Instructions .....	6-16
Prefetch and Cache Blocking Techniques .....	6-18
Single-pass versus Multi-pass Execution .....	6-23
Memory Bank Conflicts .....	6-25
Non-temporal Stores and Software Write-Combining ....	6-25
Cache Management .....	6-26
Video Encoder .....	6-27

Video Decoder .....	6-27
Conclusions from Video Encoder and Decoder Implementation .....	6-28
Using Prefetch and Streaming-store for a Simple Memory Copy.....	6-28
TLB Priming .....	6-29
Optimizing the 8-byte Memory Copy .....	6-29

## **Chapter 7 Application Performance Tools**

VTune™ Performance Analyzer.....	7-2
Using Sampling Analysis for Optimization .....	7-2
Time-based Sampling .....	7-2
Event-based Sampling .....	7-4
Sampling Performance Counter Events .....	7-4
Call Graph Profiling.....	7-7
Call Graph Window .....	7-7
Static Code Analysis .....	7-9
Static Assembly Analysis .....	7-10
Dynamic Assembly Analysis .....	7-10
Code Coach Optimizations.....	7-11
Assembly Coach Optimization Techniques .....	7-13
Intel Compiler Plug-in .....	7-14
Code Optimization Options .....	7-14
Interprocedural and Profile-Guided Optimizations .....	7-17
Intel Performance Library Suite .....	7-18
Benefits Summary.....	7-19
Libraries Architecture .....	7-19
Optimizations with Performance Library Suite .....	7-20
Register Viewing Tool (RVT).....	7-21
Register Data .....	7-21
Disassembly Data .....	7-21

---

## Appendix A Optimization of Some Key Algorithms for the Pentium III Processors

Newton-Raphson Method with the Reciprocal Instructions...	A-2
Performance Improvements .....	A-3
Newton-Raphson Method for Reciprocal Square Root ....	A-3
Newton-Raphson Inverse Reciprocal Approximation .....	A-5
3D Transformation Algorithms .....	A-7
Aos and SoA Data Structures .....	A-8
Performance Improvements .....	A-8
SoA .....	A-8
Prefetching .....	A-9
Avoiding Dependency Chains .....	A-9
Implementation .....	A-9
Assembly Code for SoA Transformation .....	A-13
Motion Estimation .....	A-14
Performance Improvements .....	A-14
Sum of Absolute Differences .....	A-15
Prefetching .....	A-15
Implementation .....	A-15
Upsample .....	A-15
Performance Improvements .....	A-16
Streaming SIMD Extensions Implementation of the Upsampling Algorithm .....	A-16
FIR Filter Algorithm Using Streaming SIMD Extensions .....	A-17
Performance Improvements for Real FIR Filter .....	A-17
Parallel Multiplication and Interleaved Additions .....	A-17
Reducing Data Dependency and Register Pressure .	A-17
Scheduling for the Reorder Buffer and the Reservation Station .....	A-18
Wrapping the Loop Around (Software Pipelining) .....	A-18
Advancing Memory Loads .....	A-19
Separating Memory Accesses from Operations .....	A-19

Unrolling the Loop .....	A-19
Minimizing Pointer Arithmetic/Eliminating Unnecessary Micro-ops .....	A-20
Prefetch Hints .....	A-20
Minimizing Cache Pollution on Write .....	A-20
Performance Improvements for the Complex FIR Filter ..	A-21
Unrolling the Loop .....	A-21
Reducing Non-Value-Added Instructions .....	A-21
Complex FIR Filter Using a SIMD Data Structure .....	A-21
Code Samples .....	A-22

## **Appendix B Performance-Monitoring Events and Counters**

Performance-affecting Events .....	B-1
Programming Notes .....	B-13
RDPMC Instruction .....	B-13
Instruction Specification .....	B-13

## **Appendix C Instruction to Decoder Specification**

## **Appendix D Streaming SIMD Extensions Throughput and Latency**

## **Appendix E Stack Alignment for Streaming SIMD Extensions**

Stack Frames .....	E-1
Aligned esp-Based Stack Frames .....	E-4
Aligned ebp-Based Stack Frames .....	E-6
Stack Frame Optimizations .....	E-9
Inlined Assembly and ebx .....	E-9

## **Appendix F The Mathematics of Prefetch Scheduling Distance**

Simplified Equation .....	F-1
Mathematical Model for PSD .....	F-2
No Preloading or Prefetch .....	F-5
Compute Bound (Case: $T_c \geq T_l + T_b$ ) .....	F-7

---

Compute Bound (Case: $T_I + T_b > T_c > T_b$ ) .....	F-8
Memory Throughput Bound (Case: $T_b \geq T_c$ ) .....	F-9
Example .....	F-10

## Examples

2-1 Prediction Algorithm .....	2-4
2-2 Misprediction Example .....	2-5
2-3 Assembly Equivalent of Conditional C Statement .....	2-6
2-4 Code Optimization to Eliminate Branches .....	2-6
2-5 Eliminating Branch with CMOV Instruction .....	2-7
2-6 Partial Register Stall .....	2-9
2-7 Partial Register Stall with Pentium II and Pentium III Processors .....	2-9
2-8 Simplifying the Blending of Code in Pentium II and Pentium III Processors .....	2-10
2-9 Scheduling Instructions for the Decoder .....	2-15
2-10 Scheduling Floating-Point Instructions .....	2-22
2-11 Coding for a Floating-Point Register File .....	2-22
2-12 Using the FXCH Instruction .....	2-23
2-13 Large and Small Load Stalls .....	2-25
2-14 Algorithm to Avoid Changing the Rounding Mode .....	2-26
2-15 Loop Unrolling .....	2-28
2-16 Hiding One-Clock Latency .....	2-29
3-1 Identification of MMX Technology with cpuid .....	3-2
3-2 Identification of Streaming SIMD Extensions with cpuid 3-3	
3-3 Identification of Streaming SIMD Extensions by the OS .....	3-4
3-4 Simple Four-Iteration Loop .....	3-9
3-5 Streaming SIMD Extensions Using Inlined Assembly Encoding .....	3-10
3-6 Simple Four-Iteration Loop Coded with Intrinsics .....	3-11
3-7 C++ Code Using the Vector Classes .....	3-13

3-8	Automatic Vectorization for a Simple Loop .....	3-14
3-9	C Algorithm for 64-bit Data Alignment .....	3-17
3-10	AoS data structure .....	3-22
3-11	SoA data structure .....	3-22
3-12	Pseudo-code Before Strip Mining .....	3-24
3-13	A Strip Mining Code .....	3-25
3-14	Loop Blocking .....	3-26
4-1	Resetting the Register between __m64 and FP Data Types .....	4-5
4-2	Unsigned Unpack Instructions .....	4-8
4-3	Signed Unpack Instructions .....	4-9
4-4	Interleaved Pack with Saturation .....	4-11
4-5	Interleaved Pack without Saturation .....	4-12
4-6	Unpacking Two Packed-word Sources in a Non-interleaved Way .....	4-13
4-7	Complex Multiply by a Constant .....	4-14
4-8	Absolute Difference of Two Unsigned Numbers .....	4-15
4-9	Absolute Difference of Signed Numbers .....	4-16
4-10	Computing Absolute Value .....	4-17
4-11	Clipping to an Arbitrary Signed Range [high, low] .....	4-18
4-12	Simplified Clipping to an Arbitrary Signed Range .....	4-19
4-13	Clipping to an Arbitrary Unsigned Range [high, low] ..	4-20
4-14	Generating Constants .....	4-20
4-15	pextrw Instruction Code .....	4-22
4-16	pinsrw Instruction Code .....	4-23
4-17	pmovmskb Instruction Code .....	4-24
4-18	pshuf Instruction Code .....	4-26
4-19	A Large Load after a Series of Small Stalls .....	4-28
4-20	Accessing Data without Delay .....	4-29
4-21	A Series of Small Loads after a Large Store .....	4-29
4-22	Eliminating Delay for a Series of Small Loads after a Large Store .....	4-30
5-1	Pseudocode for Horizontal (xyz, AoS) Computation .....	5-9



5-2	Pseudocode for Vertical (xxxx, yyyy, zzzz, SoA) Computation .....	5-9
5-3	Swizzling Data .....	5-10
5-4	Swizzling Data Using Intrinsics .....	5-12
5-5	Deswizzling Data .....	5-14
5-6	Deswizzling Data Using the movlhps and shuffle Instructions .....	5-15
5-7	Deswizzling Data Using Intrinsics with the movlhps and shuffle Instructions .....	5-16
5-8	Using MMX Technology Code for Copying or Shuffling .....	5-18
5-9	Horizontal Add Using movhps/movlhps .....	5-20
5-10	Horizontal Add Using Intrinsics with movhps/movlhps .....	5-21
5-11	Scheduling Instructions that Use the Same Register ..	5-22
5-12	Scheduling with the Triple/Quadruple Rule .....	5-25
5-13	Proper Scheduling for Performance Increase .....	5-29
5-14	Scheduling with Emulated Conditional Branch .....	5-32
5-15	Replacing the Streaming SIMD Extensions Code with the MMX Technology Code .....	5-34
5-16	Typical Dot Product Implementation .....	5-35
6-1	Prefetch Scheduling Distance .....	6-13
6-2	Using Prefetch Concatenation .....	6-14
6-3	Concatenation and Unrolling the Last Iteration of Inner Loop .....	6-15
6-4	Prefetch and Loop Unrolling .....	6-16
6-5	Spread Prefetch Instructions .....	6-17
6-6	Data Access of a 3D Geometry Engine without Strip-mining .....	6-21
6-7	Data Access of a 3D Geometry Engine with Strip-mining .....	6-22
6-8	Basic Algorithm of a Simple Memory Copy .....	6-28
6-9	An Optimized 8-byte Memory Copy .....	6-30

A-1	Newton-Raphson Method for Reciprocal Square Root Approximation .....	A-4
A-2	Newton-Raphson Inverse Reciprocal Approximation ....	A-5
A-3	Transform SoA Functions, C Code .....	A-10
E-1	Aligned esp-Based Stack Frames .....	E-5
E-2	Aligned ebp-based Stack Frames .....	E-6
F-1	Calculating Insertion for Scheduling Distance of 3 .....	F-3

## Figures

1-1	The Complete Pentium II and Pentium III Processors Architecture .....	1-2
1-2	TExecution Units and Ports in the Out-Of-Order Core 1-10	
1-3	TStreaming SIMD Extensions Data Type .....	1-14
1-4	TStreaming SIMD Extensions Register Set .....	1-14
1-5	TMMX Technology 64-bit Data Type .....	1-15
1-6	TMMX Technology Register Set .....	1-16
2-1	TPentium II Processor Static Branch Prediction Algorithm .....	2-4
2-2	DCU Split in the Data Cache .....	2-13
3-1	Converting to Streaming SIMD Extensions Chart .....	3-5
3-2	Hand-Coded Assembly and High-Level Compiler Performance Tradeoffs .....	3-9
3-3	Loop Blocking Access Pattern .....	3-27
4-1	Using EMMS to Reset the Tag after an MMX Instruction .....	4-4
4-2	PACKSSDW mm, mm/mm64 Instruction Example ....	4-10
4-3	Interleaved Pack with Saturation .....	4-10
4-4	Result of Non-Interleaved Unpack in MM0 .....	4-12
4-5	Result of Non-Interleaved Unpack in MM1 .....	4-13
4-6	pextrw Instruction .....	4-22
4-7	pinsrw Instruction .....	4-23
4-8	pmovmskb Instruction Example .....	4-24

4-9	pshuf Instruction Example .....	4-25
4-10	PSADBW Instruction Example .....	4-26
5-1	Dot Product Operation .....	5-8
5-2	Horizontal Add Using movhps/movlhps .....	5-19
5-3	Modulo Scheduling Dependency Graph .....	5-26
6-1	Memory Access Latency and Execution Without Prefetch .....	6-11
6-2	Memory Access Latency and Execution With Prefetch .....	6-11
6-3	Cache Blocking - Temporally Adjacent and Non-adjacent Passes .....	6-19
6-4	Examples of Prefetch and Strip-mining for Temporally Adjacent and Non-adjacent Passes Loops .....	6-20
6-5	Benefits of Incorporating Prefetch into Code .....	6-23
6-6	Single-Pass vs. Multi-Pass 3D Geometry Engines .....	6-24
7-1	Sampling Analysis of Hotspots by Location .....	7-3
7-2	Processor Events List .....	7-5
7-3	Call Graph Window .....	7-8
7-4	Code Coach Optimization Advice .....	7-12
7-5	The RVT: Registers and Disassembly Window .....	7-22
E-1	Stack Frames Based on Alignment Type .....	E-3
F-1	Pentium II and Pentium III Processors Memory Pipeline Sketch .....	F-4
F-2	Execution Pipeline, No Preloading or Prefetch .....	F-6
F-3	Compute Bound Execution Pipeline .....	F-7
F-4	Compute Bound Execution Pipeline .....	F-8
F-5	Memory Throughput Bound Pipeline .....	F-9
F-6	Accesses per Iteration, Example 1 .....	F-11
F-7	Accesses per Iteration, Example 2 .....	F-12

## Tables

1-1	Pentium II and Pentium III Processors Execution Units .....	1-8
-----	---	-----

4-1	Port Assignments .....	4-7
5-1	EMMS Instruction Usage Guidelines .....	5-4
5-2	SoA Form of Representing Vertices Data .....	5-7
5-3	EMMS Modulo Scheduling .....	5-27
5-4	EMMS Schedule – Overlapping Iterations .....	5-27
5-5	Modulo Scheduling with Interval MRT (II=4) .....	5-28
B-1	Performance Monitoring Events .....	B-2
C-1	Pentium II and Pentium III Processors Instruction to Decoder Specification .....	C-1
C-2	MMX Technology Instruction to Decoder Specification .....	C-17
D-1	Streaming SIMD Extensions Throughput and Latency .....	D-1

# *Introduction*

---

Developing high-performance applications for Intel® architecture (IA)-based processors can be more efficient with better understanding of the newest IA. Even though the applications developed for the 8086/8088, 80286, Intel386™ (DX or SX), and Intel486™ processors will execute on the Pentium®, Pentium Pro, Pentium II and Pentium III processors without any modification or recompiling, the code optimization techniques combined with the advantages of the newest processors can help you tune your application to its greatest potential. This manual provides information on Intel architecture as well as describes code optimization techniques to enable you to tune your application for best results, specifically when run on Pentium II and Pentium III processors.

## **Tuning Your Application**

Tuning an application to high performance across Intel architecture-based processors requires background information about the following:

- the Intel architecture.
- critical stall situations that may impact the performance of your application and other performance setbacks within your application
- your compiler optimization capabilities
- monitoring the application's performance

To help you understand your application and where to begin tuning, you can use Intel's VTune™ Performance Analyzer. This tool helps you see the performance event counters data of your code provided by the Pentium II and Pentium III processors. This manual informs you about appropriate

performance counter for measurement. For VTune Performance Analyzer order information, see its web home page at <http://developer.intel.com/vtune>.

## About This Manual

This manual assumes that you are familiar with IA basics, as well as with C or C++ and assembly language programming. The manual consists of the following parts:

**Introduction.** Defines the purpose and outlines the contents of this manual.

**Chapter 1—Processor Architecture Overview.** Overviews the architectures of the Pentium II and Pentium III processors.

**Chapter 2—General Optimization Guidelines.** Describes the code development techniques to utilize the architecture of Pentium II and Pentium III processors as well as general strategies of efficient memory utilization.

**Chapter 3—Coding for SIMD Architectures.** Describes the following coding methodologies: assembly, inlined-assembly, intrinsics, vector classes, auto-vectorization, and libraries. Also discusses strategies for altering data layout and restructuring algorithms for SIMD-style coding.

**Chapter 4—Using SIMD Integer Instructions.** Describes optimization rules and techniques for high-performance integer and MMX™ technology applications.

**Chapter 5—Optimizing Floating-Point Applications.** Describes rules and optimization techniques, and provides code examples specific to floating-point code, including SIMD-floating point code for Streaming SIMD Extensions.

**Chapter 6—Optimizing Cache Utilization for Pentium III Processors.** Describes the memory hierarchy of Pentium II and Pentium III processor architectures, and how to best use it. The `prefetch` instruction and cache control management instructions for Streaming SIMD Extensions are also described.

**Chapter 7—Application Performance Tools.** Describes application performance tools: VTune analyzer, Intel® Compiler plug-ins, and Intel® Performance Libraries Suite. For each tool, techniques and code optimization strategies that help you to take advantage of the Intel architecture are described.

**Appendix A—Optimization of Some Key Algorithms for the Pentium II and Pentium III Processors.** Describes how to optimize the following common algorithms using the Streaming SIMD Extensions: 3D lighting and transform, image compression, audio decomposition, and others.

**Appendix B—Performance Monitoring Events and Counters.** Describes performance-monitoring events and counters and their functions.

**Appendix C—Instruction to Decoder Specification.** Summarizes the IA macro instructions with Pentium II and Pentium III processor decoding information to enable scheduling.

**Appendix D—Streaming SIMD Extensions Throughput and Latency.** Summarizes in a table the instructions' throughput and latency characteristics.

**Appendix E—Stack Alignment for Streaming SIMD Extensions.** Details on the alignment of the stacks of data for Streaming SIMD Extensions.

**Appendix F—The Mathematics of Prefetch Scheduling Distance.** Discusses how far away prefetch instructions should be inserted.

## Related Documentation

For more information on the Intel architecture, specific techniques and processor architecture terminology referenced in this manual, see the following documentation:

*Intel Architecture MMX™ Technology Programmer's Reference Manual*, order number 243007

*Pentium Processor Family Developer's Manual*, Volumes 1, 2, and 3, order numbers 241428, 241429, and 241430

*Pentium Pro Processor Family Developer's Manual*, Volumes 1, 2, and 3, order numbers 242690, 242691, and 242692

*Pentium II Processor Developer's Manual*, order number 243502

*Intel C/C++ Compiler for Win32\* Systems User's Guide*, order number 718195

## Notational Conventions

This manual uses the following conventions:

- |                               |  |
|-------------------------------|--|
| <i>This type style</i>        | Indicates an element of syntax, a reserved word, a keyword, a filename, instruction, computer output, or part of a program example. The text appears in lowercase unless uppercase is significant.   |
| <b>THIS TYPE STYLE</b>        | Indicates a value, for example, <b>TRUE</b> , <b>CONST1</b> , or a variable, for example, <b>A</b> , <b>B</b> , or register names <b>MM0</b> through <b>MM7</b> .<br><br><b>l</b> indicates lowercase letter L in examples. <b>1</b> is the number 1 in examples. <b>O</b> is the uppercase O in examples. <b>0</b> is the number 0 in examples. |
| <i>This type style</i>        | Indicates a placeholder for an identifier, an expression, a string, a symbol, or a value. Substitute one of these items for the placeholder.   |
| ... (ellipses)                | Indicate that a few lines of the code are omitted.   |
| <u><i>This type style</i></u> | Indicates a hypertext link.  |



# *Processor Architecture Overview*

---

# 1

This chapter provides an overview of the architectural features of the Pentium® II and Pentium III processors and explains the new capabilities of the Pentium III processor. The Streaming SIMD Extensions of the Pentium III processor introduce new general purpose integer and floating-point SIMD instructions, which accelerate applications performance over the Pentium II processors.

## **The Processors' Execution Architecture**

The Pentium II and Pentium III processors are aggressive microarchitectural implementations of the 32-bit Intel® architecture (IA). They are designed with a dynamic execution architecture that provides the following features:

- out-of-order speculative execution to expose parallelism
- superscalar issue to exploit parallelism
- hardware register renaming to avoid register name space limitations
- pipelined execution to enable high clock speeds
- branch prediction to avoid pipeline delays

The microarchitecture is designed to execute legacy 32-bit Intel architecture code as quickly as possible, without additional effort from the programmer. This optimization manual assists the developer in leveraging the features of the microarchitecture to attain greater performance by understanding and working with these features to maximally enhance performance.

## The Pentium® II and Pentium III Processors Pipeline

The Pentium II and Pentium III processors' pipelines contain three parts:

- the in-order issue front end
- the out-of-order core
- the in-order retirement unit.

Figure 1-1 gives an overview of the Pentium II and Pentium III processors architecture.

**Figure 1-1 The Complete Pentium II and Pentium III Processors Architecture**

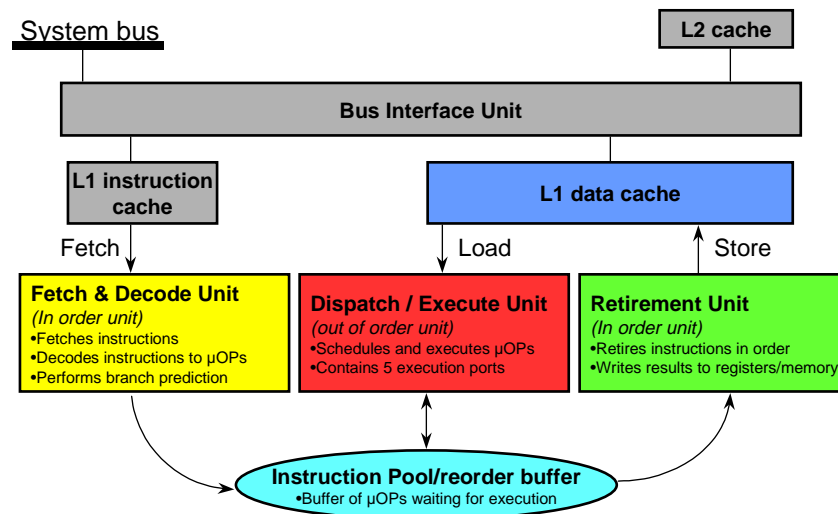

### The In-order Issue Front End

The front end supplies instructions in program order to the out-of-order core. It fetches and decodes Intel architecture-based processor macroinstructions, and breaks them down into simple operations called micro-ops ( $\mu$ ops). It can issue multiple  $\mu$ ops per cycle, in original program order, to the out-of-order core. Since the core aggressively reorders and executes instructions out of program order, the most important consideration in performance tuning is to ensure that enough  $\mu$ ops are ready

for execution. Accurate branch prediction, instruction prefetch, and fast decoding are essential to getting the most performance out of the in-order front end.

### **The Out-of-order Core**

The core's ability to execute instructions out of order is a key factor in exploiting parallelism. This feature enables the processor to reorder instructions so that if one  $\mu$ op is delayed while waiting for data or a contended resource, other  $\mu$ ops that are later in program order may proceed around it. The processor employs several buffers to smooth the flow of  $\mu$ ops. This implies that when one portion of the pipeline experiences a delay, that delay may be covered by other operations executed in parallel or by executing  $\mu$ ops which were previously queued up in a buffer. The delays described in this chapter are treated in this manner.

The out-of-order core buffers  $\mu$ ops in a Reservation Station (RS) until their operands are ready and resources are available. Each cycle, the core may dispatch up to five  $\mu$ ops, as explained in more detail later in the chapter.

The core is designed to facilitate parallel execution. Load and store instructions may be issued simultaneously. Most simple operations, such as integer operations, floating-point add, and floating-point multiply, can be pipelined with a throughput of one or two operations per clock cycle. Long latency operations can proceed in parallel with short latency operations.

### **In-Order Retirement Unit**

For semantically-correct execution, the results of instructions must be processed in original program order. Likewise, any exceptions that occur must be processed in program order. When a  $\mu$ op completes and writes its result, it is retired. Up to three  $\mu$ ops may be retired per cycle. The unit in the processor which buffers completed  $\mu$ ops is the reorder buffer (ROB). ROB updates the architectural state in order, that is, updates the state of instructions and registers in the program semantics order. ROB also manages the ordering of exceptions.

## Front-End Pipeline Detail

For better understanding operation of the Pentium II and Pentium III processors, this section explains the main processing units of their front-end pipelines: instruction prefetcher, decoders, and branch prediction.

### Instruction Prefetcher

The instruction prefetcher performs aggressive prefetch of straight line code. The Pentium II and Pentium III processors read in instructions from 16-byte-aligned boundaries. For example, if the modulo 16 branch target address (the address of a label) is equal to 14, only two useful instruction bytes are fetched in the first cycle. The rest of the instruction bytes are fetched in subsequent cycles.



---

**NOTE.** *Instruction fetch is always intended for an aligned 16-byte block.*

---

### Decoders

Pentium II and Pentium III processors have three decoders. In each clock cycle, the first decoder is capable of decoding one macroinstruction made up of four or fewer  $\mu$ ops. It can handle any number of bytes up to the maximum of 15, but nine- or more-byte instructions require additional cycles. In each clock cycle, the other two decoders can each decode an instruction of one  $\mu$ op, and up to eight bytes. Instructions composed of more than four  $\mu$ ops take multiple cycles to decode.

Simple instructions have one to four  $\mu$ ops; complex instructions (for example, `cmpxchg`) generally have more than four  $\mu$ ops. Complex instructions require multiple cycles to decode.

During every clock cycle, up to three macroinstructions are decoded. However, if the instructions are complex or are over seven bytes long, the decoder is limited to decoding fewer instructions. The decoders can decode:

- up to three macroinstructions per clock cycle
- up to six  $\mu$ ops per clock cycle

When programming in assembly language, try to schedule your instructions in a 4-1-1  $\mu$ op sequence, which means instruction with four  $\mu$ ops followed by two instructions each with one  $\mu$ op. Scheduling the instructions in a 4-1-1  $\mu$ op sequence increases the number of instructions that can be decoded during one clock cycle.

Most commonly used instructions have the following  $\mu$ op numbers:

- Simple instructions of the register-register form have only one  $\mu$ op.
- Load instructions are only one  $\mu$ op.
- Store instructions have two  $\mu$ ops.
- Simple read-modify instructions are two  $\mu$ ops.
- Simple instructions of the register-memory form have two to three  $\mu$ ops.
- Simple read-modify-write instructions have four  $\mu$ ops.

See Appendix C, “[Instruction to Decoder Specification](#)” for a table specifying the number of  $\mu$ ops required by each instruction in the Intel architecture instruction set.

## Branch Prediction Overview

Pentium II and Pentium III processors use a branch target buffer (BTB) to predict the direction and target of branches based on an instruction’s address. The address of the branch instruction is available before the branch has been decoded, so a BTB-based prediction can be made as early as possible to avoid delays caused by going the wrong direction on a branch. The 512-entry BTB stores the history of previously-seen branches and their targets. When a branch is prefetched, the BTB feeds the target address directly into the instruction fetch unit (IFU). Once the branch is executed, the BTB is updated with the target address. Using the branch target buffer allows dynamic prediction of previously seen branches.

Once the branch instruction is decoded, the direction of the branch (forward or backward) is known. If there was not a valid entry in the BTB for the branch, the static predictor makes a prediction based on the direction of the branch.

## Dynamic Prediction

The branch target buffer prediction algorithm includes pattern matching and can track up to the last four branch directions per branch address. For example, a loop with four or fewer iterations should have about 100% correct prediction.

Additionally, Pentium II and Pentium III processors have a return stack buffer (RSB) that can predict return addresses for procedures that are called from different locations in succession. This increases the benefit of unrolling loops containing function calls. It also mitigates the need to put certain procedures in-line since the return penalty portion of the procedure call overhead is reduced.

Pentium II and Pentium III processors have three levels of branch support that can be quantified in the number of cycles lost:

1. Branches that are not taken suffer no penalty. This applies to those branches that are correctly predicted as not taken by the BTB, and to forward branches that are not in the BTB and are predicted as not taken by default.
2. Branches that are correctly predicted as taken by the BTB suffer a minor penalty of losing one cycle of instruction fetch. As with any taken branch, the decode of the rest of the µops after the branch is wasted.
3. Mispredicted branches suffer a significant penalty. The penalty for mispredicted branches is at least nine cycles (the length of the in-order issue pipeline) of lost instruction fetch, plus additional time spent waiting for the mispredicted branch instruction to retire. This penalty is dependent upon execution circumstances. Typically, the average number of cycles lost because of a mispredicted branch is between 10 and 15 cycles and possibly as many as 26 cycles.

## Static Prediction

Branches that are not in the BTB, but are correctly predicted by the static prediction mechanism, suffer a small penalty of about five or six cycles (the length of the pipeline to this point). This penalty applies to unconditional direct branches that have never been seen before.

The static prediction mechanism predicts backward conditional branches (those with negative displacement), such as loop-closing branches, as taken. They suffer only a small penalty of approximately six cycles the first time the branch is encountered and a minor penalty of approximately one cycle on subsequent iterations when the negative branch is correctly predicted by the BTB. Forward branches are predicted as not taken.

The small penalty for branches that are not in the BTB but are correctly predicted by the decoder is approximately five cycles of lost instruction fetch. This compares to 10-15 cycles for a branch that is incorrectly predicted or that has no prediction.

In order to take advantage of the forward-not-taken and backward-taken static predictions, the code should be arranged so that the likely target of the branch immediately follows forward branches. See examples on branch prediction in [“Branch Prediction” in Chapter 2](#).

## Execution Core Detail

To successfully implement parallelism, information on execution units' latency is required. Also important is the information on the execution units layout in the pipelines and on the  $\mu$ ops that execute in pipelines. This section details on the execution core operation including the discussion on instruction latency and throughput, execution units and ports, caches, and store buffers.

### Instruction Latency and Throughput

The core's ability to exploit parallelism can be enhanced by ordering instructions so that their operands are ready and their corresponding execution units are free when they reach the reservation stations. Knowing instructions' latencies helps in scheduling instructions appropriately. Some execution units are not pipelined, such that  $\mu$ ops cannot be dispatched in consecutive cycles and the throughput is less than one per cycle. Table 1-1 lists Pentium II and Pentium III processors execution units, their latency, and their issue throughput.

**Table 1-1 Pentium II and Pentium III Processors Execution Units**

Port	Execution Units	Latency/Throughput
0	Integer ALU Unit:	Latency 1, Throughput 1/cycle
	LEA instructions	Latency 1, Throughput 1/cycle
	Shift instructions	Latency 1, Throughput 1/cycle
	Integer Multiplication instruction	Latency 4, Throughput 1/cycle
	Floating-Point Unit:	
	FADD instruction	Latency 3, Throughput 1/cycle (horizontal align with FADD)
	FMUL instruction	Latency 5, Throughput 1/2cycle <sup>1</sup> (align with FMULL)
	FDIV instruction	Latency: single-precision 18 cycles, double-precision 32 cycles, extended-precision 38 cycles. Throughput non-pipelined (align with FDIV)
MMX™ technology ALU Unit	MMX technology Multiplier Unit	Latency 1, Throughput 1/cycle
	MMX technology Multiplier Unit	Latency 3, Throughput 1/cycle
	MMX technology Multiplier Unit	Latency 3, Throughput 1/cycle
Streaming SIMD Extensions Floating Point Unit: Multiply, Divide, Square Root, Move instructions		See Appendix D, " <a href="#">Streaming SIMD Extensions Throughput and Latency</a> "
		See Appendix D, " <a href="#">Streaming SIMD Extensions Throughput and Latency</a> "
1	Integer ALU Unit	Latency 1, Throughput 1/cycle
	MMX technology ALU Unit	Latency 1, Throughput 1/cycle
	MMX technology Shift Unit	Latency 1, Throughput 1/cycle
	MMX technology Shift Unit	Latency 1, Throughput 1/cycle
Streaming SIMD Extensions: Adder, Reciprocal and Reciprocal Square Root, Shuffle/Move instructions		See Appendix D, " <a href="#">Streaming SIMD Extensions Throughput and Latency</a> "
		See Appendix D, " <a href="#">Streaming SIMD Extensions Throughput and Latency</a> "

continued



**Table 1-1 Pentium II and Pentium III Processors Execution Units (continued)**

Port	Execution Units	Latency/Throughput
2	Load Unit	Latency 3 on a cache hit, Throughput 1/cycle
	Streaming SIMD Extensions Load instructions	See Appendix D, " <a href="#">Streaming SIMD Extensions Throughput and Latency</a> "
3	Store Address Unit	Latency 0 or 3 (not on critical path), Throughput 1/cycle <sup>2</sup>
	Streaming SIMD Extensions Store instruction	See Appendix D, " <a href="#">Streaming SIMD Extensions Throughput and Latency</a> "
4	Store Data Unit	Latency 1, Throughput 1/cycle
	Streaming SIMD Extensions Store instruction	See Appendix D, " <a href="#">Streaming SIMD Extensions Throughput and Latency</a> "

1. The FMUL unit cannot accept a second FMUL in the cycle after it has accepted the first. This is NOT the same as only being able to do FMULs on even clock cycles. FMUL is pipelined once every two clock cycles.
2. A load that gets its data from a store to the same address can dispatch in the same cycle as the store, so in that sense the latency of the store is 0. The store itself takes three cycles to complete, but that latency affects only how soon a store buffer entry is freed for use by another  $\mu$ op.

### Execution Units and Ports

Each cycle, the core may dispatch zero or one  $\mu$ op on a port to any of the five pipelines (shown in Figure 1-2) for a maximum issue bandwidth of five  $\mu$ ops per cycle. Each pipeline contains several execution units. The  $\mu$ ops are dispatched to the pipeline that corresponds to its type of operation. For example, an integer arithmetic logic unit (ALU) and the floating-point execution units (adder, multiplier, and divider) share a pipeline. Knowledge of which  $\mu$ ops are executed in the same pipeline can be useful in ordering instructions to avoid resource conflicts.

**Figure 1-2 Execution Units and Ports in the Out-Of-Order Core**

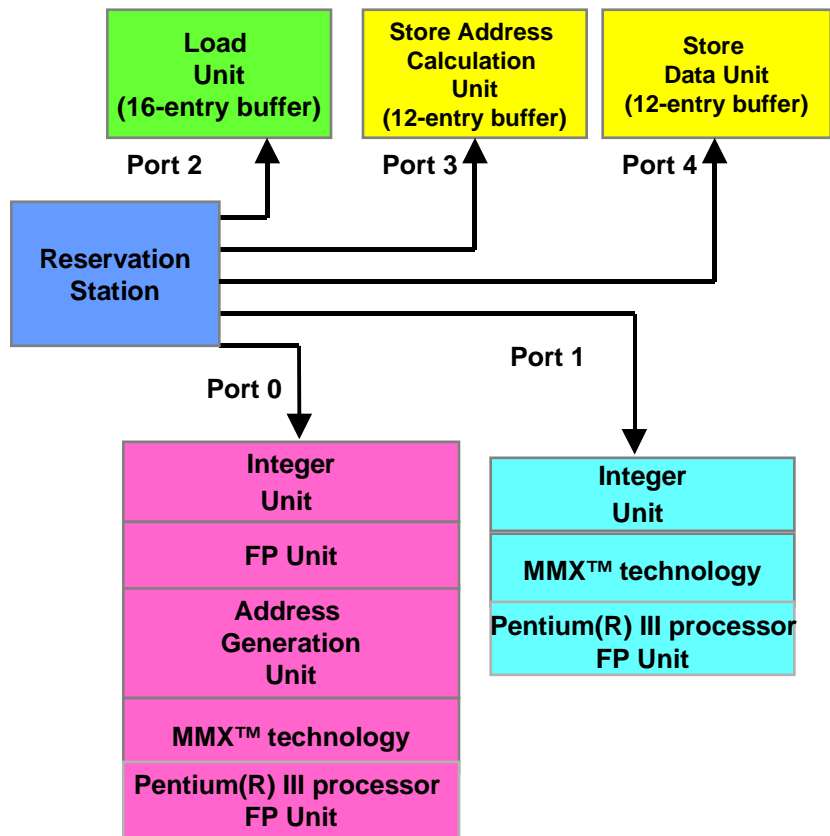

### Caches of the Pentium II and Pentium III Processors

The on-chip cache subsystem of Pentium II and Pentium III processors consists of two 16-Kbyte four-way set associative caches with a cache line length of 32 bytes. The caches employ a write-back mechanism and a pseudo-LRU (least recently used) replacement algorithm. The data cache consists of eight banks interleaved on four-byte boundaries.

Level two (L2) caches have been off chip but in the same package. They are 128K or more in size. L2 latencies are in the range of 4 to 10 cycles. An L2 miss initiates a transaction across the bus to memory chips. Such an access requires on the order of at least 11 additional bus cycles, assuming a DRAM page hit. A DRAM page miss incurs another three bus cycles. Each bus cycle equals several processor cycles, for example, one bus cycle for a 100 MHz bus is equal to four processor cycles on a 400 MHz processor. The speed of the bus and sizes of L2 caches are implementation dependent, however. Check the specifications of a given system to understand the precise characteristics of the L2 cache.

### Store Buffers

Pentium II and Pentium III processors have twelve store buffers. These processors temporarily store each write (store) to memory in a store buffer. The store buffer improves processor performance by allowing the processor to continue executing instructions without having to wait until a write to memory and/or cache is complete. It also allows writes to be delayed for more efficient use of memory-access bus cycles.

Writes stored in the store buffer are always written to memory in program order. Pentium II and Pentium III processors use processor ordering to maintain consistency in the order in which data is read (loaded) and written (stored) in a program and the order in which the processor actually carries out the reads and writes. With this type of ordering, reads can be carried out speculatively; and in any order, reads can pass buffered writes, while writes to memory are always carried out in program order.

Write hits cannot pass write misses, so performance of critical loops can be improved by scheduling the writes to memory. When you expect to see write misses, schedule the write instructions in groups no larger than twelve, and schedule other instructions before scheduling further write instructions.

## Streaming SIMD Extensions of the Pentium III Processor

The Streaming SIMD Extensions of the Pentium III processor accelerate performance of applications over the Pentium II processors, for example, 3D graphics. The programming model is similar to the MMX™ technology model except that instructions now operate on new packed floating-point data types, which contain four single-precision floating-point numbers.

The Streaming SIMD Extensions of the Pentium III processor introduce new general purpose floating-point instructions, which operate on a new set of eight 128-bit Streaming SIMD Extensions registers. This gives the programmer the ability to develop algorithms that can mix packed single-precision floating-point and integer using both Streaming SIMD Extensions and MMX instructions respectively. In addition to these instructions, Streaming SIMD Extensions technology also provide new instructions to control cacheability of all data types. These include ability to stream data into the processor while minimizing pollution of the caches and the ability to prefetch data before it is actually used. Both 64-bit integer and packed floating point data can be streamed to memory.

The main focus of packed floating-point instruction is the acceleration of 3D geometry. The new definition also contains additional SIMD integer instructions to accelerate 3D rendering and video encoding and decoding. Together with the cacheability control instructions, this combination enables the development of new algorithms that can significantly accelerate 3D graphics and other applications that involve intensive computation.

The new Streaming SIMD Extensions state requires operating system support for saving and restoring the new state during a context switch. A new set of extended `fsave/frstor` (called `fxsave/fxrstor`) permits saving/restoring new and existing state for applications and operating systems. To make use of these new instructions, an application must verify that the processor and operating system support Streaming SIMD Extensions. If both do, then the software application can use the new features.

The Streaming SIMD Extensions are fully compatible with all software written for Intel architecture microprocessors. All existing software continues to run correctly, without modification, on microprocessors that incorporate the Streaming SIMD Extensions, as well as in the presence of existing and new applications that incorporate this technology.

## Single-Instruction, Multiple-Data (SIMD)

The Streaming SIMD Extensions support operations on packed single-precision floating-point data types, and the additional SIMD integer instructions support operations on packed quadword data types (byte, word, or double-word). This approach was chosen because most 3D graphics and digital signal processing (DSP) applications have the following characteristics:

- inherently parallel
- wide dynamic range, hence floating-point based
- regular and re-occurring memory access patterns
- localized re-occurring operations performed on the data
- data-independent control flow.

Streaming SIMD Extensions fully support the IEEE Standard 754 for Binary Floating-Point Architecture. The Streaming SIMD Extensions are accessible from all IA execution modes: protected mode, real-address mode, and Virtual 8086 mode.

## New Data Types

The principal data type of the Streaming SIMD Extensions are a packed single-precision floating-point operand, specifically four 32-bit single-precision (SP) floating-point numbers shown in Figure 1-3. The SIMD integer instructions operate on the packed byte, word, or double-word data types. The prefetch instructions work on a cache line granularity regardless of type.

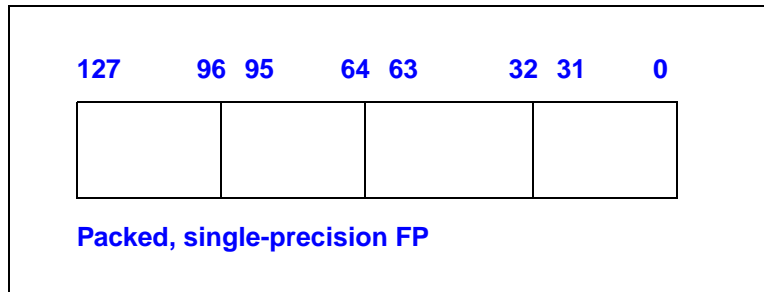
**Figure 1-3 Streaming SIMD Extensions Data Type****Streaming SIMD Extensions Registers**

The Streaming SIMD Extensions provide eight 128-bit general-purpose registers, each of which can be directly addressed. These registers are a new state, requiring support from the operating system to use them. They can hold packed, 128-bit data, and are accessed directly by the Streaming SIMD Extensions using the register names XMM0 to XMM7, see Figure 1-4.

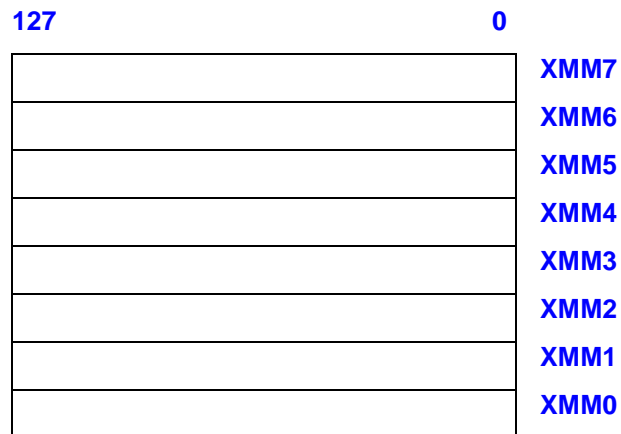
**Figure 1-4 Streaming SIMD Extensions Register Set**

## MMX™ Technology

Intel’s MMX™ technology is an extension to the Intel architecture (IA) instruction set. The technology uses a single instruction, multiple data (SIMD) technique to speed up multimedia and communications software by processing data elements in parallel. The MMX instruction set adds 57 opcodes and a 64-bit quadword data type. The 64-bit data type, illustrated in Figure 1-5, holds packed integer values upon which MMX instructions operate.

In addition, there are eight 64-bit MMX technology registers, each of which can be directly addressed using the register names MM0 to MM7. Figure 1-6 shows the layout of the eight MMX technology registers.

**Figure 1-5 MMX Technology 64-bit Data Type**

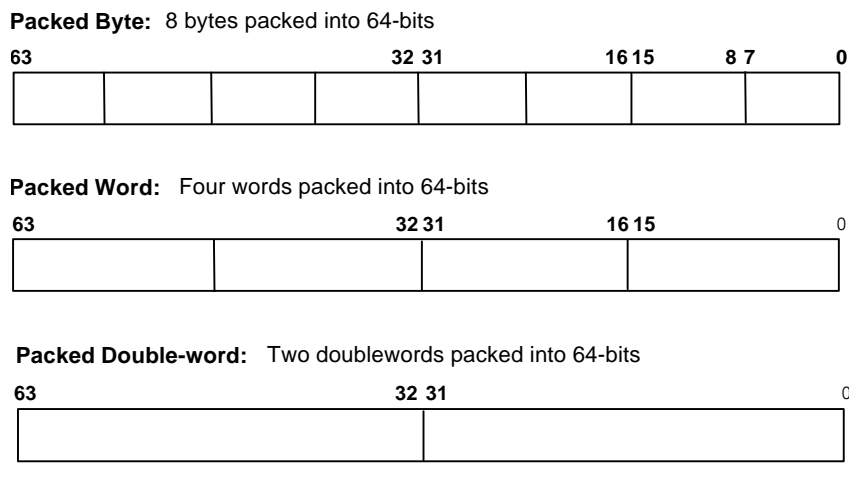

**Figure 1-6 MMX Technology Register Set**

---

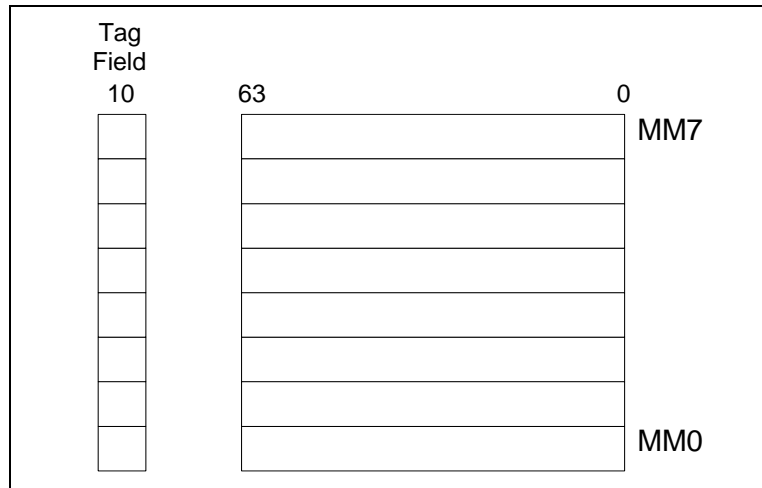

The MMX technology is operating-system-transparent and 100% compatible with all existing Intel architecture software. Therefore all applications will continue to run on processors with MMX technology. Additional information and details about the MMX instructions, data types, and registers can be found in the *Intel Architecture MMX™ Technology Programmer's Reference Manual*, order number 243007.



# General Optimization Guidelines

## 2

This chapter discusses general optimization techniques that can improve the performance of applications for the Pentium® II and Pentium III processor architectures. It discusses general guidelines as well as specifics of each guideline and provides examples of how to improve your code.

### Integer Coding Guidelines

The following guidelines will help you optimize your code:

- Use a current generation of compiler, such as the Intel® C/C++ Compiler that will produce an optimized application.
- Write code so that Intel compiler can optimize it for you:
  - Minimize use of global variables, pointers, and complex control flow
  - Use the `const` modifier, avoid `register` modifier
  - Avoid indirect calls and use the type system
  - Use minimum sizes for integer and floating-point data types to enable SIMD parallelism
- Improve branch predictability by using the branch prediction algorithm. This is one of the most important optimizations for Pentium II processors. Improving branch predictability allows the code to spend fewer cycles fetching instructions due to fewer mispredicted branches.
- Take advantage of the SIMD capabilities of MMX™ technology and Streaming SIMD Extensions.
- Avoid partial register stalls.
- Ensure proper data alignment.

- Arrange code to minimize instruction cache misses and optimize prefetch.
- Avoid prefixed opcodes other than 0F.
- Avoid small loads after large stores to the same area of memory. Avoid large loads after small stores to the same area of memory. Load and store data to the same area of memory using the same data sizes and address alignments.
- Use software pipelining.
- Avoid self-modifying code.
- Avoid placing data in the code segment.
- Calculate store addresses as early as possible.
- Avoid instructions that contain four or more  $\mu$ ops or instructions that are more than seven bytes long. If possible, use instructions that require one  $\mu$ op.
- Cleanse partial registers before calling callee-save procedures.

## Branch Prediction

Branch optimizations are one of the most important optimizations for Pentium II processors. Understanding the flow of branches and improving the predictability of branches can increase the speed of your code significantly.

## Dynamic Branch Prediction

Dynamic prediction is always attempted first by checking the branch target buffer (BTB) for a valid entry. If one is not there, static prediction is used. Three elements of dynamic branch prediction are important:

- If the instruction address is not in the BTB, execution is predicted to continue without branching. This is known as “fall-through” meaning that the branch is not taken and the subsequent instruction is executed.
- Predicted taken branches have a one clock delay.
- The Pentium II and Pentium III processors’ BTB pattern matches on the direction of the last four branches to dynamically predict whether a branch will be taken.

During the process of instruction prefetch the address of a conditional instruction is checked with the entries in the BTB. When the address is not in the BTB, execution is predicted to fall through to the next instruction. This suggests that branches should be followed by code that will be executed. The code following the branch will be fetched, and in the case of Pentium Pro, Pentium II processors, and Pentium III processor the fetched instructions will be speculatively executed. Therefore, never follow a branch instruction with data.

Additionally, when an instruction address for a branch instruction is in the BTB and it is predicted taken, it suffers a one-clock delay on Pentium II processors. To avoid the delay of one clock for taken branches, simply insert additional work between branches that are expected to be taken. This delay restricts the minimum duration of loops to two clock cycles. If you have a very small loop that takes less than two clock cycles, unroll it to remove the one-clock overhead of the branch instruction.

The branch predictor on Pentium II processors correctly predicts regular patterns of branches—up to a length of four. For example, it correctly predicts a branch within a loop that is taken on odd iterations, and not taken on even iterations.

## Static Prediction

On Pentium II and Pentium III processors, branches that do not have a history in the BTB are predicted using a static prediction algorithm as follows:

- Predict unconditional branches to be taken.
- Predict backward conditional branches to be taken. This rule is suitable for loops.
- Predict forward conditional branches to be NOT taken.

A branch that is statically predicted can lose, at most, six cycles of instruction prefetch. An incorrect prediction suffers a penalty of greater than twelve clocks. Example 2-1 provides the static branch prediction algorithm.

## Figure 2-1 Pentium® II Processor Static Branch Prediction Algorithm

---

Forward conditional branches not taken (fall through)

```
If <condition> {  
...  
↓  
}
```

```
for <condition> {  
...  
↓  
}
```

Unconditional Branches taken  
JMP →

Backward Conditional Branches are taken

```
loop {  
↑  
} <condition>
```

---

Example 2-1 and Example 2-2 illustrate the basic rules for the static prediction algorithm.

### Example 2-1 Prediction Algorithm

---

```
Begin: mov  eax,    mem32  
       and  eax,   ebx  
       imul eax,   edx  
       shld  eax,   7  
       JC   Begin
```

---

In the above example, the backward branch (JC Begin) is not in the BTB the first time through, therefore, the BTB does not issue a prediction. The static predictor, however, will predict the branch to be taken, so a misprediction will not occur.

---

**Example 2-2 Misprediction Example**

---

```
mov eax, mem32
and eax, ebx
    imul eax, edx
    shld eax, 7
    JC  Begin
    mov  eax, 0
Begin  Call Convert
```

---

The first branch instruction (`JC Begin`) in Example 2-3 segment is a conditional forward branch. It is not in the BTB the first time through, but the static predictor will predict the branch to fall through.

The `Call Convert` instruction will not be predicted in the BTB the first time it is seen by the BTB, but the call will be predicted as taken by the static prediction algorithm. This is correct for an unconditional branch.

In these examples, the conditional branch has only two alternatives: taken and not taken. Indirect branches, such as switch statements, computed `GOTOS` or calls through pointers, can jump to an arbitrary number of locations. Assuming the branch has a skewed target destination, and most of the time it branches to the same address, then the BTB will predict accurately most of the time. If, however, the target destination is not predictable, performance can degrade quickly. Performance can be improved by changing the indirect branches to conditional branches that can be predicted.

## Eliminating and Reducing the Number of Branches

Eliminating branches improves performance due to:

- Reducing the possibility of mispredictions.
- Reducing the number of required BTB entries.

Using the `setcc` instruction, or using the Pentium II and Pentium III processors' conditional move (`cmov` or `fcmov`) instructions can eliminate branches.

Following is a C code line with a condition that is dependent upon one of the constants:

```
X = (A < B) ? C1 : C2;
```

This code conditionally compares two values, **A** and **B**. If the condition is true, **X** is set to **C1**; otherwise it is set to **C2**. The assembly equivalent is shown in the Example 2-3:

### Example 2-3 Assembly Equivalent of Conditional C Statement

---

```
cmp    A, B      ; condition
jge    L30       ; conditional branch
mov    ebx, CONST1 ; ebx holds X
jmp    L31       ; unconditional branch
L30:
mov    ebx, CONST2
L31:
```

---

If you replace the `jge` instruction in the previous example with a `setcc` instruction, this code can be optimized to eliminate the branches as shown in the Example 2-4:

### Example 2-4 Code Optimization to Eliminate Branches

---

```
xor    ebx, ebx   ;clear ebx (X in the C code)
cmp    A, B
setge  ebx        ;When ebx = 0 or 1
                    ;OR the complement condition
dec    ebx        ;ebx=00...00 or 11...11
and    ebx, (CONST1-CONST2);ebx=0 or(CONST1-CONST2)
add    ebx, CONST2 ;ebx=CONST1 or CONST2
```

---

The optimized code sets `ebx` to zero, then compares **A** and **B**. If **A** is greater than or equal to **B**, `ebx` is set to one. Then `ebx` is decreased and “and-ed” with the difference of the constant values. This sets `ebx` to either zero or the

difference of the values. By adding `CONST2` back to `ebx`, the correct value is written to `ebx`. When `CONST1` is equal to zero, the last instruction can be deleted.

Another way to remove branches on Pentium II and Pentium III processors is to use the `cmov` and `fcmov` instructions. Example 2-5 shows changing a test and branch instruction sequence using `cmov` and eliminating a branch. If the test sets the equal flag, the value in `ebx` will be moved to `eax`. This branch is data-dependent, and is representative of an unpredictable branch.

### Example 2-5 Eliminating Branch with CMOV Instruction

---

```
test ecx, ecx
jne lh
mov  eax, ebx
lh:
; To change the code, the jne and the mov instructions
; are combined into one cmovcc instruction that checks
; the equal flag. The optimized code is:
test    ecx, ecx    ; test the flags
cmoveq  eax, ebx    ; if the equal flag is set, move
                    ; ebx to eax
lh:
```

---

The label `lh:` is no longer needed unless it is the target of another branch instruction.

The `cmov` and `fcmov` instructions are available on the Pentium Pro, Pentium II and Pentium III processors, but not on Pentium processors and earlier 32-bit Intel architecture-based processors. Be sure to check whether a processor supports these instructions with the `cpuid` instruction if an application needs to run on older processors as well.

## Performance Tuning Tip for Branch Prediction

Intel C/C++ Compiler has a `-Qxi` switch which turns on Pentium II or Pentium III processor-specific code generation so that the compiler will generate `cmov-/fcmov` instruction sequences when possible, saving you the effort of doing it by hand.

For information on branch elimination, see the Pentium II Processor Computer Based Training (CBT), which is available with the VTune™ Performance Enhancement Environment CD at <http://developer.intel.com/vtune>.

In addition to eliminating branches, the following guidelines improve branch predictability:

- Ensure that each call has a matching return.
- Don't intermingle data and instructions.
- Unroll very short loops.
- Follow static prediction algorithm.

When a misprediction occurs the entire pipeline is flushed up to the branch instruction and the processor waits for the mispredicted branch to retire.

$$\text{Branch Misprediction Ratio} = \frac{\text{BR\_Miss\_Pred\_Ret}}{\text{BR\_Inst\_Ret}}$$

If the branch misprediction ratio is less than about 5% then branch prediction is within normal range. Otherwise, identify the branches that cause significant mispredictions and try to remedy the situation using the techniques described in the “Eliminating and Reducing the Number of Branches” earlier in this chapter.

## Partial Register Stalls

On Pentium II and Pentium III processors, when a 32-bit register (for example, `eax`) is read immediately after a 16- or 8-bit register (for example, `al`, `ah`, `ax`) is written, the read is stalled until the write retires, after a minimum of seven clock cycles. Consider Example 2-6. The first instruction moves the value 8 into the `ax` register. The following instruction accesses the register `eax`. This code sequence results in a partial register stall as shown in Example 2-6.



---

**Example 2-6 Partial Register Stall**

---

```
MOV ax, 8
ADD ecx, eax      ; Partial stall occurs on access
                  ; of the EAX register
```

---

This applies to all of the 8- and 16-bit/32-bit register pairs, listed below:

Small Registers	Large Registers:
al ah ax	eax
bl bh bx	ebx
cl ch cx	ecx
dl dh dx	edx
sp	esp
bp	ebp
di	edi
si	esi

Pentium processors do not exhibit this penalty.

Because Pentium II and Pentium III processors can execute code out of order, the instructions need not be immediately adjacent for the stall to occur. Example 2-7 also contains a partial stall.

---

**Example 2-7 Partial Register Stall with Pentium II and Pentium III Processors**

---

```
MOV al, 8
MOV edx, 0x40
MOV edi, new_value
ADD edx, eax      ; Partial stall accessing EAX
```

---

In addition, any  $\mu$ ops that follow the stalled  $\mu$ op also wait until the clock cycle after the stalled  $\mu$ op continues through the pipe. In general, to avoid stalls, do not read a large (32-bit) register (*eax*) after writing a small (8- or 16-bit) register (*al* or *ax*) which is contained in the large register.

Special cases of reading and writing small and large register pairs are implemented in Pentium II and Pentium III processors in order to simplify the blending of code across processor generations. The special cases are implemented for *xor* and *sub* when using *eax*, *ebx*, *ecx*, *edx*, *ebp*, *esp*,

`edi`, and `esi` as shown in the A. through E. series in. Generally, when implementing this sequence, always zero the large register and then write to the lower half of the register.

### Example 2-8 Simplifying the Blending of Code in Pentium II and Pentium III Processors

---

```
A.  xor  eax, eax
     movb al, mem8
     add  eax, mem32           ; no partial stall

B.  xor  eax, eax
     movw ax, mem16
     add  eax, mem32           ; no partial stall

C.  sub  ax,  ax
     movb al,  mem8
     add  ax, mem16           ; no partial stall

D.  sub  eax, eax
     movb al, mem8
     or   ax, mem16           ; no partial stall

E.  xor  ah, ah
     movb al, mem8
     sub  ax, mem16           ; no partial stall
```

---

### Performance Tuning Tip for Partial Stalls

Partial stalls can be measured by selecting the Partial Stall Events or Partial Stall Cycles events in the VTune Performance Analyzer and running a sampling on your application. Partial Stall Events show the number of events and Partial Stall Cycles show the number of cycles for partial stalls, respectively. To select the events, in the VTune analyzer, click on Configure menu\Options command\Processor Events for EBS for the list of all processor events, select one of the above events and double click on it. The

Events Customization window opens where you can set the Counter Mask for either of those events. For more details, see [“Using Sampling Analysis for Optimization” in Chapter 7](#). If a particular stall occurs more than about 3% of the execution time, then the code associated with this stall should be modified to eliminate the stall. Intel C/C++ Compiler at the default optimization level (switch `-O2`) ensures that partial stalls do not occur in the generated code.

## Alignment Rules and Guidelines

This section discusses guidelines for alignment of both code and data. On Pentium II and Pentium III processors, a misaligned access that crosses a cache line boundary does incur a penalty. A Data Cache Unit (DCU) split is a memory access that crosses a 32-byte line boundary. Unaligned accesses may cause a DCU split and stall Pentium II and Pentium III processors. For best performance, make sure that in data structures and arrays greater than 32 bytes, the structure or array elements are 32-byte-aligned and that access patterns to data structure and array elements do not break the alignment rules.

### Code

Pentium II and Pentium III processors have a cache line size of 32 bytes. Since the instruction prefetch buffers fetch on 16-byte boundaries, code alignment has a direct impact on prefetch buffer efficiency.

For optimal performance across the Intel architecture family, the following is recommended:

- Loop entry labels should be 16-byte-aligned when less than eight bytes away from a 16-byte boundary.
- Labels that follow a conditional branch need not be aligned.
- Labels that follow an unconditional branch or function call should be 16-byte-aligned when less than eight bytes away from a 16-byte boundary.
- Use a compiler that will assure these rules are met for the generated code.

On Pentium II and Pentium III processors, avoid loops that execute in less than two cycles. The target of the tight loops should be aligned on a 16-byte boundary to maximize the use of instructions that will be fetched. On Pentium II and Pentium III processors, it can limit the number of instructions available for execution, limiting the number of instructions retired every cycle. It is recommended that critical loop entries be located on a cache line boundary. Additionally, loops that execute in less than two cycles should be unrolled. See section [“MMX™ Technology” in Chapter 1](#) for more information about decoding on the Pentium II and Pentium III processors.

## Data

A misaligned data access that causes an access request for data already in the L1 cache can cost six to nine cycles. A misaligned access that causes an access request from L2 cache or from memory, however, incurs a penalty that is processor-dependent. Align the data as follows:

- Align 8-bit data at any address.
- Align 16-bit data to be contained within an aligned four byte word.
- Align 32-bit data so that its base address is a multiple of four.
- Align 64-bit data so that its base address is a multiple of eight.
- Align 80-bit data so that its base address is a multiple of sixteen.

A 32-byte or greater data structure or array should be aligned so that the beginning of each structure or array element is aligned in a way that its base address is a multiple of thirty-two.

### Data Cache Unit (DCU) Split

Figure 2-1 shows the type of code that can cause a cache split. The code loads the addresses of two `dword` arrays. In this example, every four iterations of the first two `dword` loads cause a cache split. The data declared at address 029e70feh is not 32-byte-aligned, therefore each load to this address and every load that occurs 32 bytes (every four iterations) from this address will cross the cache line boundary. When the misaligned data crosses a cache line boundary it causes a six- to twelve-cycle stall.

**Figure 2-2 DCU Split in the Data Cache**

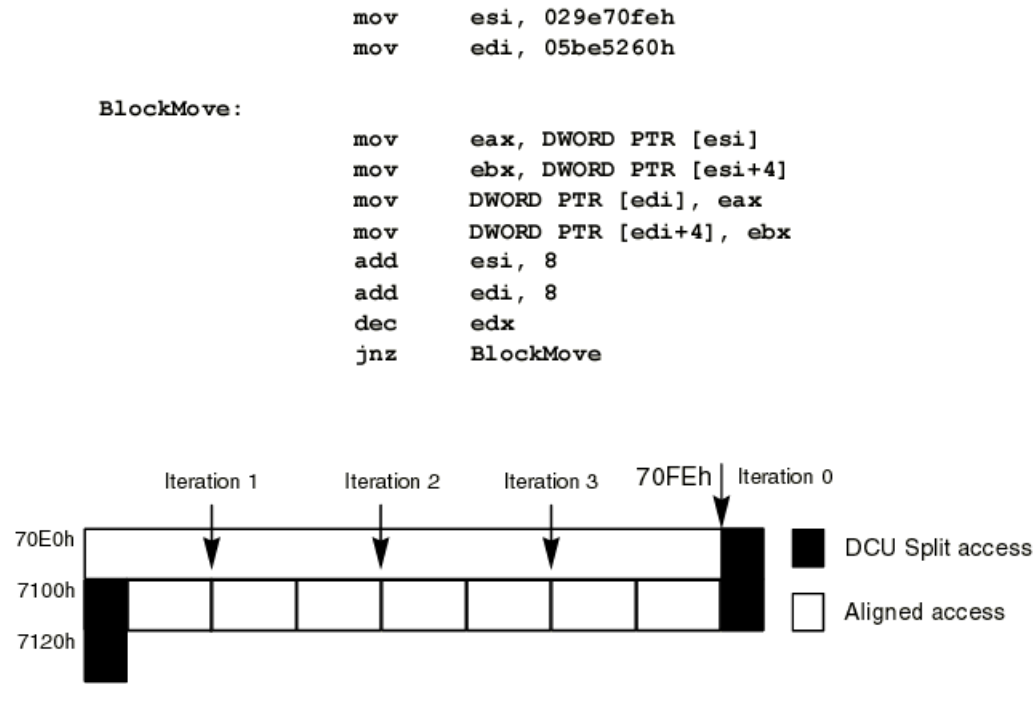

### Performance Tuning Tip for Misaligned Accesses

Misaligned data can be detected by using the Misaligned Accesses event counter on Pentium II and Pentium III processors. Use the VTune analyzer’s dynamic execution functionality to determine the exact location of a misaligned access. Code and data rearrangements for optimal memory usage are discussed in Chapter 6, “[Optimizing Cache Utilization for Pentium® III Processors.](#)”

## Instruction Scheduling

Scheduling or pipelining should be done in a way that optimizes performance across all processor generations. The following section presents scheduling rules that can improve the performance of your code on Pentium II and Pentium III processors.

### Scheduling Rules for Pentium II and Pentium III Processors

Pentium II and Pentium III processors have three decoders that translate Intel architecture (IA) macroinstructions into  $\mu$ ops as discussed in Chapter 1, “[Processor Architecture Overview](#).” The decoder limitations are as follows:

- In each clock cycle, the first decoder is capable of decoding one macroinstruction made up of four or fewer  $\mu$ ops. It can handle any number of bytes up to the maximum of 15, but nine-or-more-byte instructions require additional cycles.
- In each clock cycle, the other two decoders can each decode an instruction of one  $\mu$ op, and up to eight bytes. Instructions composed of more than four  $\mu$ ops take multiple cycles to decode.

Appendix C, “[Instruction to Decoder Specification](#),” contains a table of all Intel macroinstructions with the number of  $\mu$ ops into which they are decoded. Use this information to determine the decoder on which they can be decoded.

The macroinstructions entering the decoder travel through the pipe in order, therefore if a macroinstruction will not fit in the next available decoder, the instruction must wait until the next cycle to be decoded. It is possible to schedule instructions for the decoder so that the instructions in the in-order pipeline are less likely to be stalled.

Consider the following code series in Example 2-9.

**Example 2-9 Scheduling Instructions for the Decoder**

---

```

A.
add  eax, ecx      ; 1  $\mu$ op instruction (decoder 0)
add  edx, [ebx]   ; 2  $\mu$ op instruction (stall 1 cycle
                  ; wait till decoder 0 is available)

B.
add  eax, [ebx]   ; 2  $\mu$ op instruction (decoder 0)
mov  [eax], ecx   ; 2  $\mu$ op instruction (stall 1 cycle
                  ; to wait until decoder 0 is available)

C.
add  eax, [ebx]   ; 2  $\mu$ op instruction (decoder 0)
mov  ecx, [eax]   ; 2  $\mu$ op instruction (stall 1 cycle
                  ; to wait until decoder 0 is available)
add  ebx, 8       ; 1  $\mu$ op instruction (decoder 1)

D.
pmaddwd mm6, [ebx]; 2  $\mu$ ops instruction (decoder 0)
padd  mm7, mm6    ; 1  $\mu$ op instruction (decoder 1)
add   ebx, 8      ; 1  $\mu$ op instruction (decoder 2)

```

---

The sections of Example 2-9 are explained as follows:

- A. If the next available decoder for a multi- $\mu$ op instruction is not decoder 0, the multi-op instruction will wait for decoder 0 to be available; this usually happens in the next clock, leaving the other decoders empty during the current clock. Hence, the following two instructions will take two cycles to decode.
- B. During the beginning of the decoding cycle, if two consecutive instructions are more than one  $\mu$ op, decoder 0 will decode one instruction and the next instruction will not be decoded until the next cycle.
- C. Instructions of the **op reg, mem** type require two  $\mu$ ops: the load from memory and the operation  $\mu$ op. Scheduling for the decoder template (4-1-1) can improve the decoding throughput of your application. In general, **op reg, mem** forms of instructions are used to reduce register pressure in code that is not memory bound, and when the data is in the cache. Use simple instructions for improved speed on Pentium II and Pentium III processors.

- D. The following rules should be observed while using the `op reg, mem` instruction with MMX technology: when scheduling, keep in mind the decoder template (4-1-1) on Pentium II and Pentium III processors, as shown in Example 2-10, D.

## Prefixed Opcodes

On the Pentium II and Pentium III processors, avoid the following prefixes:

- lock
- segment override
- address size
- operand size

On Pentium II and Pentium III processors, instructions longer than seven bytes limit the number of instructions decoded in each cycle. Prefixes add one to two bytes to the length of instruction, possibly limiting the decoder.

Whenever possible, avoid prefixing instructions. Schedule them behind instructions that themselves stall the pipe for some other reason.

Pentium II and Pentium III processors can only decode one instruction at a time when an instruction is longer than seven bytes. So for best performance, use simple instructions that are less than eight bytes in length.

## Performance Tuning Tip for Instruction Scheduling

Intel C/C++ Compiler generates highly optimized code specifically for the Intel architecture-based processors. For assembly code applications, you can use the assembly coach of the VTune analyzer to get a scheduling advice, see Chapter 7, “[Application Performance Tools](#).”

## Instruction Selection

The following sections explain which instruction sequences to avoid or use when generating optimal assembly code.



## The Use of `lea` Instruction

In many cases a `lea` instruction or a sequence of `lea`, `add`, `sub`, and `shift` instructions can be used to replace constant multiply instructions. Use the integer multiply instruction to optimize code designed for Pentium II and Pentium III processors. The `lea` instruction can be used sometimes as a three/four operand addition instruction, for example,

```
lea ecx, [eax+ebx+4+a]
```

Using the `lea` instruction in this way can avoid some unnecessary register usage by not tying up registers for the operands of some arithmetic instructions.

On the Pentium II and Pentium III processors, both `lea` and `shift` instructions are single  $\mu\text{op}$  instructions that execute in one cycle. However, that short latency may not persist in future implementations. The Intel C/C++ Compiler checks to ensure that these instructions are used correctly whenever possible.

For the best blended code, replace the `shift` instruction with two or more `add` instructions, since the short latency of this instruction may not be maintained across all implementations.

## Complex Instructions

Avoid using complex instructions (for example, `enter`, `leave`, or `loop`) that generally have more than four  $\mu\text{ops}$  and require multiple cycles to decode. Use sequences of simple instructions instead.

## Short Opcodes

Use one-byte instructions as much as possible. This reduces code size and increases instruction density in the instruction cache. For example, use the `push` and `pop` instructions instead of `mov` instructions to save registers to the stack.

## 8/16-bit Operands

With eight-bit operands, try to use the byte opcodes, rather than using 32-bit operations on sign and zero-extended bytes. Prefixes for operand size override apply to 16-bit operands, not to eight-bit operands.

Sign extension is usually quite expensive. Often, the semantics can be maintained by zero-extending 16-bit operands. For example, the C code in the following statements does not need sign extension, nor does it need prefixes for operand size overrides:

```
static short int a, b;
if (a==b) {
    . . .
}
```

Code for comparing these 16-bit operands might be:

```
xor  eax, eax
xor  ebx, ebx
movw ax, [a]
movw bx, [b]
cmp  eax, ebx
```

Of course, this can only be done under certain circumstances, but the circumstances tend to be quite common. This would not work if the compare was for greater than, less than, greater than or equal, and so on, or if the values in `eax` or `ebx` were to be used in another operation where sign extension was required.

```
movsw eax, a      ; 1 prefix + 3
movsw ebx, b      ; 5
cmp  ebx, eax     ; 9
```

Pentium II and Pentium III processors provide special support to `XOR` a register with itself, recognizing that clearing a register does not depend on the old value of the register. Additionally, special support is provided for the above specific code sequence to avoid the partial stall. See [“Partial Register Stalls”](#) section for more information.

The performance of the `movzx` instructions has been improved in order to reduce the prevalence of partial stalls on Pentium II and Pentium III processors. Use the `movzx` instructions when coding for these processors.

## Comparing Register Values

Use `test` when comparing a value in a register with zero. `Test` essentially `ands` the operands together without writing to a destination register. `Test` is preferred over `and` because `and` writes the result register, which may subsequently cause an artificial output dependence on the processor. `Test` is better than `cmp ..., 0` because the instruction size is smaller.

Use `test` when comparing the result of a logical `and` with an immediate constant for equality or inequality if the register is `eax` for cases such as:

```
if (avar & 8) { }
```

## Address Calculations

Pull address calculations into load and store instructions. Internally, memory reference instructions can have four operands:

- relocatable load-time constant
- immediate constant
- base register
- scaled index register.

In the segmented model, a segment register may constitute an additional operand in the linear address calculation. In many cases, several integer instructions can be eliminated by fully using the operands of memory references.

## Clearing a Register

The preferred sequence to move zero to a register is:

```
xor reg, reg
```

This saves code space but sets the condition codes. In contexts where the condition codes must be preserved, move `0` into the register:

```
mov reg, 0
```

## Integer Divide

Typically, an integer divide is preceded by a `cdq` instruction. Divide instructions use `EDX:EAX` as the dividend and `cdq` sets up `EDX`. It is better to copy `EAX` into `EDX`, then right-shift `EDX` 31 places to sign-extend. If you know that the value is positive, use sequence

```
xor edx, edx
```

On Pentium II and Pentium III processors, the `cdq` instruction is faster since `cdq` is a single  $\mu$ op instruction as opposed to two instructions for the `copy/shift` sequence.

## Comparing with Immediate Zero

Often when a value is compared with zero, the operation produces the value sets condition codes, which can be tested directly by a `jcc` instruction. The most notable exceptions are `mov` and `lea`. In these cases, use `test`.

## Prolog Sequences

In routines that do not call other routines (leaf routines), use `ESP` as the base register to free up `EBP`. If you are not using the 32-bit flat model, remember that `EBP` cannot be used as a general purpose base register because it references the stack segment.

## Epilog Sequences

If only four bytes were allocated in the stack frame for the current function, use `pop` instructions instead of incrementing the stack pointer by four.

## Improving the Performance of Floating-point Applications

When programming floating-point applications, it is best to start at the C, C++, or FORTRAN language level. Many compilers perform floating-point scheduling and optimization when it is possible. However in order to produce optimal code, the compiler may need some assistance.

## Guidelines for Optimizing Floating-point Code

Follow these rules to improve the speed of your floating-point applications:

- Understand how the compiler handles floating-point code.
- Look at the assembly dump and see what transforms are already performed on the program.
- Study the loop nests in the application that dominate the execution time.
- Determine why the compiler is not creating the fastest code.
- See if there is a dependence that can be resolved.
- Consider large memory bandwidth requirements.
- Think of poor cache locality improvement.
- See if there is a lot of long-latency floating-point arithmetic operations.
- Do not use high precision unless necessary. Single precision (32-bits) is faster on some operations and consumes only half the memory space as double precision (64-bits) or double extended (80-bits).
- Make sure you have fast float-to-int routines. Many libraries do more work than is necessary; make sure your float-to-int is a fast routine.
- Make sure your application stays in range. Out of range numbers cause very high overhead.
- **FXCH** can be helpful by increasing the effective name space. This in turn allows instructions to be reordered to make instructions available to be executed in parallel. Out of order execution precludes the need for using **FXCH** to move instructions for very short distances.
- Unroll loops and pipeline your code.
- Perform transformations to improve memory access patterns. Use loop fusion or compression to keep as much of the computation in the cache as possible.
- Break dependency chains.

## Improving Parallelism

The Pentium II and Pentium III processors have a pipelined floating-point unit. To achieve maximum throughput from the Pentium II and Pentium III processors floating-point unit, schedule properly the floating-point instructions to improve pipelining. Consider the example in Figure 2-2.

To exploit the parallel capability of the Pentium II and Pentium III processors, determine which instructions can be executed in parallel. The two high-level code statements in the example are independent, therefore their assembly instructions can be scheduled to execute in parallel, thereby improving the execution speed, see source code in Example 2-10.

### Example 2-10 Scheduling Floating-Point Instructions

---

```
A = B + C + D;  
E = F + G + H;  
fld   B           fld   F  
fadd  C           fadd  G  
fadd  D           fadd  H  
fstp  A           fstp  E
```

---

Most floating-point operations require that one operand and the result use the top of stack. This makes each instruction dependent on the previous instruction and inhibits overlapping the instructions.

One obvious way to get around this is to imagine that we have a flat floating-point register file available, rather than a stack. The code is shown in Example 2-11.

### Example 2-11 Coding for a Floating-Point Register File

---

```
fld   B           ?F1  
fadd  F1, C       ?F1  
fld   F           ?F2  
fadd  F2,G        ?F2  
fadd  F1,D        ?F1  
fadd  F2,H        ?F2  
fstp  F1          ?A  
fstp  F2          ?E
```

---

In order to implement these imaginary registers we need to use the **FXCH** instruction to change the value on the top of stack. This provides a way to avoid the top of stack dependency. The **FXCH** instruction uses no extra execution cycles on Pentium II and Pentium III processors. Example 2-12 shows its use.

### Example 2-12 Using the FXCH Instruction

	ST0	ST1
<code>fld B</code>	$\Rightarrow$ F1	<code>fld B B</code>
<code>fadd C</code>	$\Rightarrow$ F1	<code>fadd C B+C</code>
<code>fld F</code>	$\Rightarrow$ F2	<code>fld F B+C</code>
<code>fadd G</code>	$\Rightarrow$ F2	<code>fadd G F+G B+C</code>
<code>fxch ST(1)</code>	B+C	F+G
<code>fadd D</code>	$\Rightarrow$ F1	<code>fadd D B+C+D F+G</code>
<code>fxch ST(1)</code>	F+G	B+C+D
<code>fadd H</code>	$\Rightarrow$ F2	<code>fadd H F+G+H B+C+D</code>
<code>fxch ST(1)</code>	B+C+D	F+G+H
<code>fstp D</code>	$\Rightarrow$ A	<code>fstp A F+G+H</code>
<code>fstp E</code>	$\Rightarrow$ E	<code>fstp E</code>

The **FXCH** instructions move an operand into position for the next floating-point instruction.

### Rules and Regulations of the fxch Instruction

The `fxch` instruction costs no extra cycles on Pentium II and Pentium III processors. The instruction is almost “free” and can be used to access elements in the deeper levels of the floating-point stack instead of storing them and then loading them again.

## Memory Operands

Floating-point operands that are 64-bit operands need to be eight-byte-aligned. Performing a floating-point operation on a memory operand instead of on a stack register on Pentium II or Pentium III processor, produces two  $\mu$ ops, which can limit decoding. Additionally, memory operands may cause a data cache miss, causing a penalty.

## Memory Access Stall Information

Floating-point registers allow loading of 64-bit values as doubles. Instead of loading single array values that are 8-, 16-, or 32-bits long, consider loading the values in a single quadword, then incrementing the structure or array pointer accordingly.

First, the loading and storing of quadword data is more efficient using the larger quadword data block sizes. Second, this helps to avoid the mixing of 8-, 16-, or 32-bit load and store operations with a 64-bit load and store operation to the memory address. This avoids the possibility of a memory access stall on Pentium II and Pentium III processors. Memory access stalls occur when

- small loads follow large stores to the same area of memory
- large loads follow small stores to the same area of memory.

Consider the following cases in Example 2-13. In the first case (A), there is a large load after a series of small stores to the same area of memory (beginning at memory address `mem`), and the large load will stall.

The `fld` must wait for the stores to write to memory before it can access all the data it requires. This stall can also occur with other data types (for example, when bytes or words are stored and then words or doublewords are read from the same area of memory).



---

**Example 2-13 Large and Small Load Stalls**

---

```
;A. Large load stall
mov  mem, eax    ; store dword to address "mem"
mov  mem + 4, ebx; store dword to address "mem + 4"
    :
    :
fld  mem        ; load qword at address "mem", stalls

;B. Small Load stall
fstp mem       ;store qword to address "mem"
    :
    :
mov  bx,mem+2   ;load word at address "mem + 2", stalls
mov  cx,mem+4  ;load word at address "mem + 4", stalls
```

---

In the second case (B), there is a series of small loads after a large store to the same area of memory (beginning at memory address `mem`), and the small loads will stall.

The word loads must wait for the quadword store to write to memory before they can access the data they require. This stall can also occur with other data types (for example, when doublewords or words are stored and then words or bytes are read from the same area of memory). This can be avoided by moving the store as far from the loads as possible. In general, the loads and stores should be separated by at least 10 instructions to avoid the stall condition.

## Floating-point to Integer Conversion

Many libraries provide the float to integer library routines that convert floating-point values to integer. Many of these libraries conform to ANSI C coding standards which state that the rounding mode should be truncation. The default of the `fist` instruction is round to nearest, therefore many compiler writers implement a change in the rounding mode in the processor in order to conform to the C and FORTRAN standards. This implementation requires changing the control word on the processor using

the `fldcw` instruction. This instruction is a synchronizing instruction and will cause a significant slowdown in the performance of your application on all IA-based processors.

When implementing an application, consider if the rounding mode is important to the results. If not, use the algorithm in Example to avoid the synchronization and overhead of the `fldcw` instruction and changing the rounding mode.

### Example 2-14 Algorithm to Avoid Changing the Rounding Mode

---

```
_ftol32proc
    lea    ecx,[esp-8]
    sub    esp,16 ; allocate frame
    and    ecx,-8 ; align pointer on boundary of 8
    fld    st(0) ; duplicate FPU stack top
    fistp  qword ptr[ecx]
    fild   qword ptr[ecx]
    mov    edx,[ecx+4]; high dword of integer
    mov    eax,[ecx] ; low dword of integer
    test   eax,eax
    je     integer_QNaN_or_zero
```

---

continued

**Example 2-14 Algorithm to Avoid Changing the Rounding Mode (continued)**

---

```
arg is not integer QNaN:
    fsubp    st(1),st    ; TOS=d-round(d),
                        ; { st(1)=st(1)-st & pop ST)
    test    edx,edx    ; what's sign of integer
    jns     positive   ; number is negative
                        ; dead cycle
                        ; dead cycle
    fstp    dword ptr[ecx]; result of subtraction
    mov     ecx,[ecx]   ; dword of diff(single-
                        ; precision)
    add     esp,16
    xor     ecx,80000000h

    add     ecx,7fffffffh ; if diff<0 then decrement
                        ; integer
    adc     eax,0       ; inc eax (add CARRY flag)
    ret

positive:
    fstp    dword ptr[ecx]; 17-18 result of
subtraction
    mov     ecx,[ecx]   ; dword of diff(single-
                        ; precision)
    add     esp,16
    add     ecx,7fffffffh ; if diff<0 then decrement
                        ; integer
    sbb    eax,0       ; dec eax (subtract CARRY flag)
    ret

integer_QNaN_or_zero:
    test    edx,7fffffffh
    jnz     arg_is_not_integer_QNaN
        add esp,16
    ret
```

---

## Loop Unrolling

The benefits of unrolling loops are:

- Unrolling amortizes the branch overhead. The BTB is good at predicting loops on Pentium II and Pentium III processors and the instructions to increment the loop index and jump are inexpensive.
- Unrolling allows you to aggressively schedule (or pipeline) the loop to hide latencies. This is useful if you have enough free registers to keep variables live as you stretch out the dependency chain to expose the critical path.
- You can aggressively schedule the loop to better set up I-fetch and decode constraints.
- The backwards branch (predicted as taken) has only a 1 clock penalty on Pentium II and Pentium III processors, so you can unroll very tiny loop bodies for free.

You can use a `-Qunroll` option of the Intel C/C++ Compiler, see *Intel C/C++ Compiler User's Guide for Win32\* Systems*, order number 718195.

Unrolling can expose other optimizations, as shown in Example 2-15. This example illustrates a loop executes 100 times assigning `x` to every even-numbered element and `y` to every odd-numbered element.

---

### Example 2-15 Loop Unrolling

---

```
Before unrolling:
do i=1,100
  if (i mod 2 == 0) then a(i) = x
  else a(i) = y
enddo

After unrolling
do i=1,100,2
  a(i) = y
  a(i+1) = x
enddo
```

---

By unrolling the loop you can make both assignments each iteration, removing one branch in the loop body.

## Floating-Point Stalls

Many of the floating-point instructions have a latency greater than one cycle but, because of the out-of-order nature of Pentium II and Pentium III processors, stalls will not necessarily occur on an instruction or  $\mu\text{op}$  basis. However, if an instruction has a very long latency such as an `fdiv`, then scheduling can improve the throughput of the overall application. The following sections discuss scheduling issues and offer good tips for any IA-based processor.

### Hiding the One-Clock Latency of a Floating-Point Store

A floating-point store must wait an extra cycle for its floating-point operand. After an `fld`, an `fst` must wait one clock. After the common arithmetic operations, `fmul` and `fadd`, which normally have a latency of three, `fst` waits an extra cycle for a total of four. This set also includes other instructions, for example, `faddp` and `fsubrp`, see Example 2-16.

#### Example 2-16 Hiding One-Clock Latency

```

        ; Store is dependent on the previous load.
fld     mem1   ; 1 fld takes 1 clock
        ; 2 fst waits, schedule something here
fst     mem2   ; 3,4 fst takes 2 clocks
fadd    mem1   ; 1 add takes 3 clocks
        ; 2 add, schedule something here
        ; 3 add, schedule something here
        ; 4 fst waits, schedule something here
fst     mem2   ; 5,2 fst takes 2 clocks
; Store is not dependent on the previous load:
fld     mem1   ; 1
fld     mem2   ; 2
fxch    st(1)  ; 2
fst     mem3   ; 3 stores values loaded from mem1
        ; A register may be used immediately after it has
        ; been loaded (with FLD):
fld     mem1   ; 1
fadd    mem2   ; 2,3,4

```

Use of a register by a floating-point operation immediately after it has been written by another `fadd`, `fsub`, or `fmul` causes a two-cycle delay. If instructions are inserted between these two, then latency and a potential stall can be hidden.

Additionally, while the multi-cycle floating-point instructions, `fdiv` and `fsqrt`, execute in the floating-point unit pipe, integer instructions can be executed in parallel. Emitting a number of integer instructions after such an instruction as `fdiv` or `fsqrt` will keep the integer execution units busy. The exact number of instructions depends on the floating-point instruction's cycle count.

## Integer and Floating-point Multiply

The integer multiply operations, `mul` and `imul`, are executed in the floating-point unit so these instructions cannot be executed in parallel with a floating-point instruction.

A floating-point multiply instruction (`fmul`) delays for one cycle if the immediately preceding cycle executed an `fmul` or an `fmul` / `fxch` pair. The multiplier can only accept a new pair of operands every other cycle.

For the best blended code, replace the integer multiply instruction with two or more `add` instructions, since the short latency of this instruction may not be maintained across all implementations

## Floating-point Operations with Integer Operands

Floating-point operations that take integer operands (`fiadd` or `fisub`..) should be avoided. These instructions should be split into two instructions: `fld` and a floating-point operation. The number of cycles before another instruction can be issued (throughput) for `fiadd` is four, while for `fld` and simple floating-point operations it is one, as shown in the comparison below.

### Complex Instructions

```
fiadd [ebp] ; 4
```

### Use These for Potential Overlap

```
fld [ebp] ; 1
```

```
faddp st(1) ; 2
```

Using the `fld` - `faddp` instructions yields two free cycles for executing other instructions.

### FSTSW Instructions

The `fstsw` instruction that usually appears after a floating-point comparison instruction (`fcom`, `fcomp`, `fcompp`) delays for three cycles. Other instructions may be inserted after the comparison instruction in order to hide the latency. On Pentium II and Pentium III processors the `fcmov` instruction can be used instead.

### Transcendental Functions

If an application needs to emulate these math functions in software, it may be worthwhile to inline some of these math library calls because the `call` and the prologue/epilogue involved with the calls can significantly affect the latency of the operations. Emulating these operations in software will not be faster than the hardware unless accuracy is sacrificed.





# *Coding for SIMD Architectures*

---

# 3

The capabilities of the Pentium® II and Pentium III processors enable the development of advanced multimedia applications. The Streaming SIMD Extensions and MMX™ technology provide coding extensions to make use of the processors' multimedia features, specifically, the single-instruction, multiple-data (SIMD) characteristics of the instruction set architecture (ISA). To take advantage of the performance opportunities presented by these new capabilities, take into consideration the following:

- Ensure that your processor supports MMX technology and Streaming SIMD Extensions.
- Employ all of the optimization and scheduling strategies described in this book.
- Use stack and data alignment techniques to keep data properly aligned for efficient memory use.
- Utilize the cacheability instructions offered by Streaming SIMD Extensions.

This chapter gives an overview of the capabilities that allow you to better understand SIMD features and develop applications utilizing SIMD features of MMX technology and Streaming SIMD Extensions.

## Checking for Processor Support of Streaming SIMD Extensions and MMX™ Technology

This section shows how to check whether a system supports MMX™ technology and Streaming SIMD Extensions.

### Checking for MMX Technology Support

Before you start coding with MMX technology check if MMX technology is available on your system. Use the `cputid` instruction to check the feature flags in the `edx` register. If `cputid` returns bit 23 set to 1 in the feature flags, the processor supports MMX technology. Use the code segment in Example 3-1 to load the feature flags in `edx` and test the result for the existence of MMX technology.

#### Example 3-1 Identification of MMX Technology with `cputid`

---

```
        ...identify existence of cputid instruction
...                ;
...                ; identify Intel processor
...                ;
mov eax, 1         ; request for feature flags
cputid            ; 0Fh, 0A2h cputid instruction
test edx, 00800000h; is MMX technology bit (bit
                  ; 23)in feature flags equal to 1
jnz             Found
```

---

For more information on `cputid` see, *Intel Processor Identification with CPUTID Instruction*, order number 241618. Once this check has been made, MMX technology can be included in your application in two ways:

1. Check for MMX technology during installation. If MMX technology is available, the appropriate DLLs can be installed.
2. Check for MMX technology during program execution and install the proper DLLs at runtime. This is effective for programs that may be executed on different machines.

## Checking for Streaming SIMD Extensions Support

Checking for support of Streaming SIMD Extensions on your processor is similar to doing the same for MMX technology, but you must also check whether your operating system (OS) supports Streaming SIMD Extensions. This is because the OS needs to manage saving and restoring the new state introduced by Streaming SIMD Extensions for your application to properly function.

To check whether your system supports Streaming SIMD Extensions, follow these steps:

1. Check that your processor has the `cpuid` instruction and is in the Intel Pentium II and Pentium III processors.
2. Check the feature bits of `cpuid` for Streaming SIMD Extensions existence.
3. Check for OS support for Streaming SIMD Extensions.

Example 3-2 shows how to find the Streaming SIMD Extensions feature bit (bit 25) in the `cpuid` feature flags.

### Example 3-2 Identification of Streaming SIMD Extensions with `cpuid`

---

```
...identify existence of cpuid instruction
...                ; identify Intel Processor
mov eax, 1         ; request for feature flags
cpuid             ; 0Fh, 0A2h  cpuid instruction
test EDX, 00200000h; bit 25 in feature flags equal to 1
jnz      Found
```

---

To find out whether the operating system supports Streaming SIMD Extensions, simply execute a Streaming SIMD Extension and trap for the exception if one occurs. An invalid opcode will be raised by the operating system and processor if either is not enabled for Streaming SIMD Extensions. Catching the exception in a simple try/except clause (using structured exception handling in C++) and checking whether the exception code is an invalid opcode will give you the answer. See Example 3-3.

**Example 3-3 Identification of Streaming SIMD Extensions by the OS**

---

```
bool OSSupportCheck() {
    _try {
        __asm xorps xmm0, xmm0 ;Streaming SIMD Extension
    }
    _except(EXCEPTION_EXECUTE_HANDLER) {
        if (_exception_code()==STATUS_ILLEGAL_INSTRUCTION)
            return (false); Streaming SIMD Extensions not supported
    }
    ; Streaming SIMD Extensions are supported by OS
    return (true);
}
```

---

**Considerations for Code Conversion to SIMD Programming**

The VTune™ Performance Enhancement Environment CD provides tools to aid in the evaluation and tuning. But before you start implementing them, you need to know the answers to the following questions:

1. Will the current code benefit by using MMX technology or Streaming SIMD Extensions?
2. Is this code integer or floating-point?
3. What coding techniques should I use?
4. What guidelines do I need to follow?
5. How should I arrange and align the datatypes?

Figure 3-1 provides a flowchart for the process of converting code to MMX technology or the Streaming SIMD Extensions.

**Figure 3-1 Converting to Streaming SIMD Extensions Chart**

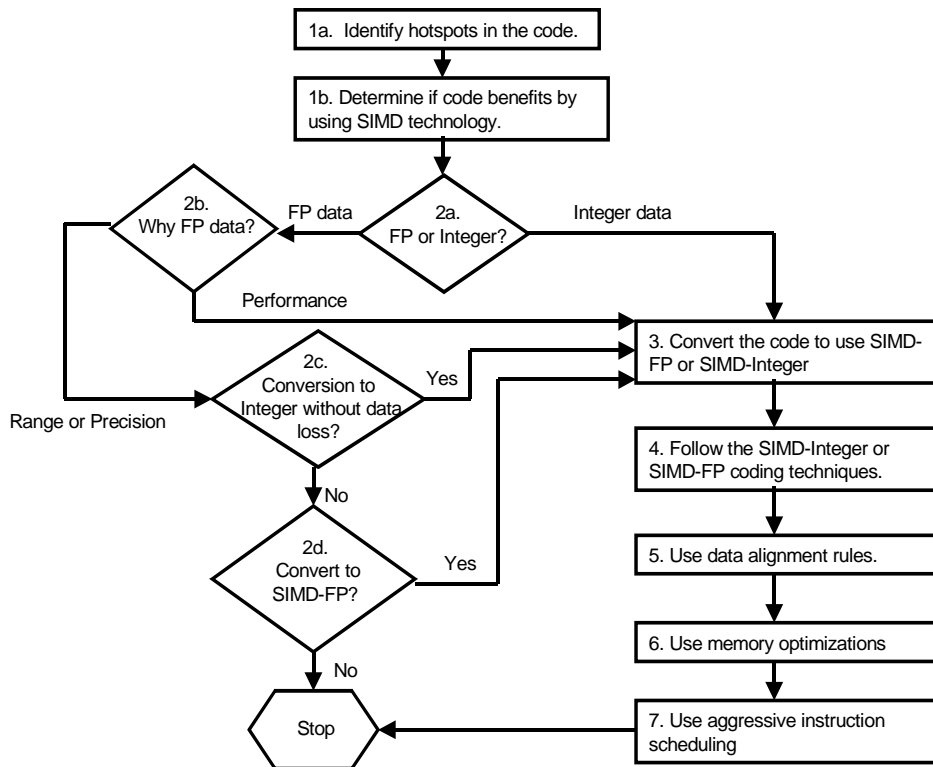

To use MMX technology or Streaming SIMD Extensions optimally, you must evaluate the following segments of your code:

- segments that are computationally intensive
- segments that require integer implementations that support efficient use of the cache architecture
- segments that require floating-point computations.

## Identifying Hotspots

To optimize performance, you can use the VTune Performance Analyzer to isolate the computation-intensive sections of code. For details on the VTune analyzer, see [“VTune™ Performance Analyzer” in Chapter 7](#). VTune analyzer provides a hotspots view of a specific module to help you identify sections in your code that take the most CPU time and that have potential performance problems. For more explanation, see section [“Using Sampling Analysis for Optimization” in Chapter 7](#), which includes an example of a hotspots report. The hotspots view helps you identify sections in your code that take the most CPU time and that have potential performance problems.

The VTune analyzer enables you to change the view to show hotspots by memory location, functions, classes, or source files. You can double-click on a hotspot and open the source or assembly view for the hotspot and see more detailed information about the performance of each instruction in the hotspot.

The VTune analyzer offers focused analysis and performance data at all levels of your source code and can also provide advice at the assembly language level. The code coach analyzes and identifies opportunities for better performance of C/C++, FORTRAN and Java\* programs, and suggests specific optimizations. Where appropriate, the coach displays pseudo-code to suggest the use of Intel’s highly optimized intrinsics and functions of the MMX technology and Streaming SIMD Extensions from Intel® Performance Library Suite. Because VTune analyzer is designed specifically for all of the Intel architecture (IA)-based processors, Pentium II and Pentium III processors in particular, it can offer these detailed approaches to working with IA. See [“Code Coach Optimizations” in Chapter 7](#), for more details and example of a code coach advice.

## Determine If Code Benefits by Conversion to Streaming SIMD Extensions

Identifying code that benefits by using MMX technology and/or Streaming SIMD Extensions can be time-consuming and difficult. Likely candidates for conversion are applications that are highly computation-intensive such as the following:

- speech compression algorithms and filters
- video display routines
- rendering routines
- 3D graphics (geometry)
- image and video processing algorithms
- spatial (3D) audio

Generally, these characteristics can be identified by the use of small-sized repetitive loops that operate on integers of 8 or 16 bits for MMX technology, or single-precision, 32-bit floating-point data for Streaming SIMD Extensions technology (integer and floating-point data items should be sequential in memory). The repetitiveness of these loops incurs costly application processing time. However, these routines have potential for increased performance when you convert them to use MMX technology or Streaming SIMD Extensions.

Once you identify your opportunities for using MMX technology or Streaming SIMD Extensions, you must evaluate what should be done to determine whether the current algorithm or a modified one will ensure the best performance.

## Coding Techniques

The SIMD features of Streaming SIMD Extensions and MMX technology require new methods of coding algorithms. One of them is vectorization. Vectorization is the process of transforming sequentially executing, or scalar, code into code that can execute in parallel, taking advantage of the SIMD architecture parallelism. Using this feature is critical for Streaming SIMD Extensions and MMX technology. This section discusses the coding techniques available for an application to make use of the SIMD architecture.

To vectorize your code and thus take advantage of the SIMD architecture, do the following:

- Determine if the memory accesses have dependencies that would prevent parallel execution
- “Strip-mine” the loop to reduce the iteration count by the length of the SIMD operations (four for Streaming SIMD Extensions and MMX technology)
- Recode the loop with the SIMD instructions

Each of these actions is discussed in detail in the subsequent sections of this chapter.

## Coding Methodologies

Software developers need to compare the performance improvement that can be obtained from assembly code versus the cost of those improvements. Programming directly in assembly language for a target platform may produce the required performance gain, however, assembly code is not portable between processor architectures and is expensive to write and maintain.

Performance objectives can be met by taking advantage of the Streaming SIMD Extensions or MMX technology ISA using high-level languages as well as assembly. The new C/C++ language extensions designed specifically for the Streaming SIMD Extensions and MMX technology help make this possible.

Figure 3-2 illustrates the tradeoffs involved in the performance of hand-coded assembly versus the ease of programming and portability.



---

**Figure 3-2 Hand-Coded Assembly and High-Level Compiler Performance Tradeoffs**

---

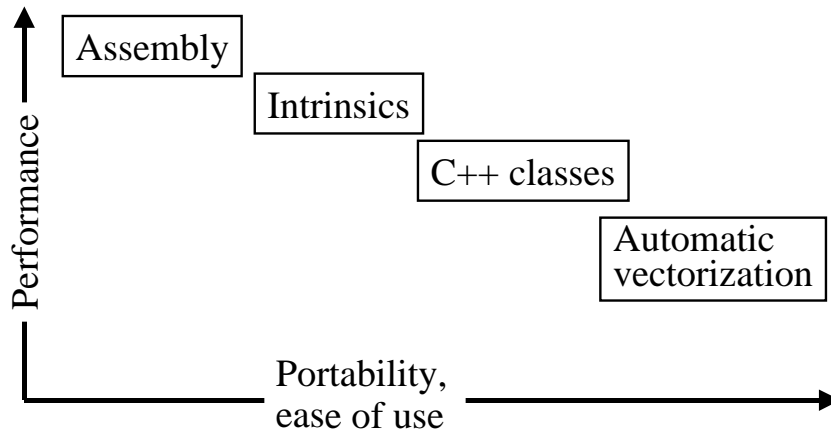

---

The examples that follow illustrate the use of assembly coding adjustments for this new ISA to benefit from the Streaming SIMD Extensions and C/C++ language extensions. Floating-point data may be used with the Streaming SIMD Extensions as well as the intrinsics and vector classes with MMX technology.

As a basis for the usage model discussed in this section, consider a simple loop shown in Example 3-4.

---

**Example 3-4 Simple Four-Iteration Loop**

---

```
void add(float *a, float *b, float *c)
{
    int i;
    for (i = 0; i < 4; i++) {
        c[i] = a[i] + b[i];
    }
}
```

---

Note that the loop runs for only four iterations. This allows a simple replacement of the code with Streaming SIMD Extensions.

For the optimal use of the Streaming SIMD Extensions that need data alignment on the 16-byte boundary, this example assumes that the arrays passed to the routine, *a*, *b*, *c*, are aligned to 16-byte boundaries by a calling routine. See Intel application note AP-833, *Data Alignment and Programming Considerations for Streaming SIMD Extensions with the Intel C/C++ Compiler*, order number 243872, for the methods to ensure this alignment.

The sections that follow detail on the following coding methodologies: inlined assembly, intrinsics, C++ vector classes, and automatic vectorization.

### Assembly

Key loops can be coded directly in assembly language using an assembler or by using inlined assembly (C-asm) in C/C++ code. The Intel compiler or assembler recognizes the new instructions and registers, then directly generates the corresponding code. This model offers the greatest performance, but this performance is not portable across the different processor architectures.

Example 3-5 shows the Streaming SIMD Extensions inlined-asm encoding.

---

#### Example 3-5 Streaming SIMD Extensions Using Inlined Assembly Encoding

---

```
void add(float *a, float *b, float *c)
{
    __asm {
        mov     eax, a
        mov     edx, b
        mov     ecx, c
        movaps  xmm0, XMMWORD PTR [eax]
        addps   xmm0, XMMWORD PTR [edx]
        movaps  XMMWORD PTR [ecx], xmm0
    }
}
```

---

## Intrinsics

Intrinsics provide the access to the ISA functionality using C/C++ style coding instead of assembly language. Intel has defined two sets of intrinsic functions that are implemented in the Intel C/C++ Compiler to support the MMX technology and the Streaming SIMD Extensions. Two new C data types, representing 64-bit and 128-bit objects (`__m64` and `__m128`, respectively) are used as the operands of these intrinsic functions. This enables to choose the implementation of an algorithm directly, while also performing optimal register allocation and instruction scheduling where possible. These intrinsics are portable among all Intel architecture-based processors supported by a compiler. The use of intrinsics allows you to obtain performance close to the levels achievable with assembly. The cost of writing and maintaining programs with intrinsics is considerably less. For a detailed description of the intrinsics and their use, refer to the *Intel C/C++ Compiler User's Guide*.

Example 3-6 shows the loop from Example 3-4 using intrinsics.

### Example 3-6 Simple Four-Iteration Loop Coded with Intrinsics

---

```
#include <xmmintrin.h>
void add(float *a, float *b, float *c)
{
    __m128 t0, t1;
    t0 = _mm_load_ps(a);
    t1 = _mm_load_ps(b);
    t0 = _mm_add_ps(t0, t1);
    _mm_store_ps(c, t0);
}
```

---

The intrinsics map one-to-one with actual Streaming SIMD Extensions assembly code. The `xmmintrin.h` header file in which the prototypes for the intrinsics are defined is part of the Intel C/C++ Compiler for Win32\* Systems included with the VTune Performance Enhancement Environment CD.

Intrinsics are also defined for the MMX technology ISA. These are based on the `__m64` data type to represent the contents of an `mm` register. You can specify values in bytes, short integers, 32-bit values, or as a 64-bit object.

The `__m64` and `__m128` data types, however, are not a basic ANSI C data type, and therefore you must observe the following usage restrictions:

- Use `__m64` and `__m128` data only on the left-hand side of an assignment as a return value or as a parameter. You cannot use it with other arithmetic expressions (“+”, “>>”, and so on).
- Use `__m64` and `__m128` objects in aggregates, such as unions to access the byte elements and structures; the address of an `__m64` object may be also used.
- Use `__m64` and `__m128` data only with the MMX intrinsics described in this guide.

For complete details of the hardware instructions, see the *Intel Architecture MMX™ Technology Programmer’s Reference Manual*. For descriptions of data types, see the *Intel Architecture Software Developer’s Manual, Volume 2: Instruction Set Reference Manual*.

## Classes

Intel has also defined a set of C++ classes to provide both a higher-level abstraction and more flexibility for programming with MMX technology and the Streaming SIMD Extensions. These classes provide an easy-to-use and flexible interface to the intrinsic functions, allowing developers to write more natural C++ code without worrying about which intrinsic or assembly language instruction to use for a given operation. Since the intrinsic functions underlie the implementation of these C++ classes, the performance of applications using this methodology can approach that of one using the intrinsics. Further details on the use of these classes can be found in the *Intel C++ Class Libraries for SIMD Operations User’s Guide*, order number 693500.

Example 3-7 shows the C++ code using a vector class library. The example assumes the arrays passed to the routine are already aligned to 16-byte boundaries.

---

**Example 3-7 C++ Code Using the Vector Classes**

---

```
#include <fvec.h>
void add(float *a, float *b, float *c)
{
    F32vec4 *av=(F32vec4 *) a;
    F32vec4 *bv=(F32vec4 *) b;
    F32vec4 *cv=(F32vec4 *) c;

    *cv=*av + *bv
}
```

---

Here, `fvec.h` is the class definition file and `F32vec4` is the class representing an array of four floats. The “+” and “=” operators are overloaded so that the actual Streaming SIMD Extensions implementation in the previous example is abstracted out, or hidden, from the developer. Note how much more this resembles the original code, allowing for simpler and faster programming.

Again, the example is assuming the arrays passed to the routine are already aligned to 16-byte boundary.

### Automatic Vectorization

The Intel C/C++ Compiler provides an optimization mechanism by which simple loops, such as in Example 3-4 can be automatically vectorized, or converted into Streaming SIMD Extensions code. The compiler uses similar techniques to those used by a programmer to identify whether a loop is suitable for conversion to SIMD. This involves determining whether the following might prevent vectorization:

- the layout of the loop and the data structures used
- dependencies amongst the data accesses in each iteration and across iterations

Once the compiler has made such a determination, it can generate vectorized code for the loop, allowing the application to use the SIMD instructions.

The caveat to this is that only certain types of loops can be automatically vectorized, and in most cases user interaction with the compiler is needed to fully enable this.

Example 3-8 shows the code for automatic vectorization for the simple four-iteration loop (from Example 3-4).

### Example 3-8 Automatic Vectorization for a Simple Loop

---

```
void add (float *restrict a,  
         float *restrict b,  
         float *restrict c)  
{  
    int i;  
    for (i = 0; i < 100; i++) {  
        c[i] = a[i] + b[i];  
    }  
}
```

---

Compile this code using the `-Qvec` and `-Qrestrict` switches of the Intel C/C++ Compiler, version 4.0 or later.

The `restrict` qualifier in the argument list is necessary to let the compiler know that there are no other aliases to the memory to which the pointers point. In other words, the pointer for which it is used, provides the only means of accessing the memory in question in the scope in which the pointers live. Without this qualifier, the compiler will not vectorize the loop because it cannot ascertain whether the array references in the loop overlap, and without this information, generating vectorized code is unsafe.

Refer to the *Intel C/C++ Compiler User's Guide for Win32 Systems*, order number 718195, for more details on the use of automatic vectorization.

## Stack and Data Alignment

To get the most performance out of code written for MMX technology and Streaming SIMD Extensions, data should be formatted in memory according to the guidelines described in this section. A misaligned access in assembly code is a lot more costly than an aligned access.

### Alignment of Data Access Patterns

The new 64-bit packed data types defined by MMX technology, and the 128-bit packed data types for Streaming SIMD Extensions create more potential for misaligned data accesses. The data access patterns of many algorithms are inherently misaligned when using MMX technology and Streaming SIMD Extensions.

However, when accessing SIMD data using SIMD operations, access to data can be improved simply by a change in the declaration. For example, consider a declaration of a structure, which represents a point in space. The structure consists of three 16-bit values plus one 16-bit value for padding. The sample declaration follows:

```
typedef struct { short x,y,z; short junk; } Point;
Point pt[N];
```

In the following code,

```
for (i=0; i<N; i++) pt[i].y *= scale;
```

the second dimension `y` needs to be multiplied by a scaling value. Here the `for` loop accesses each `y` dimension in the array `pt` thus avoiding the access to contiguous data, which can cause a serious number of cache misses and degrade the performance of the application.

The following declaration allows you to vectorize the scaling operation and further improve the alignment of the data access patterns:

```
short ptx[N], pty[N], ptz[N];
for (i=0; i<N; i++) pty *= scale;
```

With the SIMD technology, choice of data organization becomes more important and should be made carefully based on the operations that will be performed on the data. In some applications, traditional data arrangements may not lead to the maximum performance.

A simple example of this is an FIR filter. An FIR filter is effectively a vector dot product in the length of the number of coefficient taps.

Consider the following code:

```
(data [ j ] *coeff [0] + data [j+1]*coeff [1]+...+data [j+num of taps-1]*coeff [num of taps-1]),
```

If in the code above the filter operation of data element *i* is the vector dot product that begins at data element *j*, then the filter operation of data element *i+1* begins at data element *j+1*.

Assuming you have a 64-bit aligned data vector and a 64-bit aligned coefficients vector, the filter operation on the first data element will be fully aligned. For the second data element, however, access to the data vector will be misaligned. The Intel application note AP-559, *MMX Instructions to Compute a 16-Bit Real FIR Filter*, order number 243044, shows an example of how to avoid the misalignment problem in the FIR filter.

Duplication and padding of data structures can be used to avoid the problem of data accesses in algorithms which are inherently misaligned.



---

**CAUTION.** *The duplication and padding technique overcomes the misalignment problem, thus avoiding the expensive penalty for misaligned data access, at the price of increasing the data size. When developing your code, you should consider this tradeoff and use the option which gives the best performance.*

---

## Stack Alignment For Streaming SIMD Extensions

For best performance, the Streaming SIMD Extensions require their memory operands to be aligned to 16-byte (16B) boundaries. Unaligned data can cause significant performance penalties compared to aligned data. However, the existing software conventions for IA-32 (`stdcall`, `cdecl`, `fastcall`) as implemented in most compilers, do not provide any



mechanism for ensuring that certain local data and certain parameters are 16-byte aligned. Therefore, Intel has defined a new set of IA-32 software conventions for alignment to support the new `__m128` datatype that meets the following conditions:

- Functions that use Streaming SIMD Extensions data need to provide a 16-byte aligned stack frame.
- The `__m128` parameters need to be aligned to 16-byte boundaries, possibly creating “holes” (due to padding) in the argument block

These new conventions presented in this section as implemented by the Intel C/C++ Compiler can be used as a guideline for an assembly language code as well. In many cases, this section assumes the use of the `__m128` data type, as defined by the Intel C/C++ compiler, which represents an array of four 32-bit floats.

For more details on the stack alignment for Streaming SIMD Extensions, see Appendix E, “[Stack Alignment for Streaming SIMD Extensions.](#)”

## Data Alignment for MMX Technology

Many compilers enable alignment of variables using controls. This aligns the variables’ bit lengths to the appropriate boundaries. If some of the variables are not appropriately aligned as specified, you can align them using the C algorithm shown in Example 3-9.

### Example 3-9 C Algorithm for 64-bit Data Alignment

---

```
#include <stdio.h>
#include<stdlib.h>
#include<malloc.h>
void main(void)
{
    double a[5] ;
    double *p, *newp;
    double i, res;
```

continued

**Example 3-9 C Algorithm for 64-bit Data Alignment (continued)**

---

```
p = (double*)malloc (((sizeof a[0])*5)+4);
                    newp = ((unsigned int>(&p)+4) & (~0x7));
/*
res =0;
for(i =0; i<4; i++)
{
    res += a[i];
}
printf("res = %ld\n",res);
*/

}
```

---

The algorithm in Example 3-9 aligns a 64-bit variable on a 64-bit boundary. Once aligned, every access to this variable saves six to nine cycles on the Pentium II and Pentium III processors when the misaligned data previously crossed a cache line boundary.

Another way to improve data alignment is to copy the data into locations that are aligned on 64-bit boundaries. When the data is accessed frequently, this can provide a significant performance improvement.

**Data Alignment for Streaming SIMD Extensions**

Data must be 16-byte-aligned when using the Streaming SIMD Extensions to avoid severe performance penalties at best, and at worst, execution faults. Although there are move instructions (and intrinsics) to allow unaligned data to be copied into and out of Streaming SIMD Extension registers when not using aligned data, such operations are much slower than aligned accesses. If, however, the data is not 16-byte-aligned and the programmer or the compiler does not detect this and uses the aligned instructions, a fault will occur. So, the rule is: keep the data 16-byte-aligned. Such alignment will also work for MMX technology code, even though MMX technology

only requires 8-byte alignment. The following discussion and examples describe alignment techniques for Pentium III processor as implemented with the Intel C/C++ Compiler.

### Compiler-Supported Alignment

The Intel C/C++ Compiler provides the following methods to ensure that the data is aligned.

**Alignment by `F32vec4` or `__m128` Data Types.** When compiler detects `F32vec4` or `__m128` data declarations or parameters, it will force alignment of the object to a 16-byte boundary for both global and local data, as well as parameters. If the declaration is within a function, the compiler will also align the function's stack frame to ensure that local data and parameters are 16-byte-aligned. Please refer to the Intel application note AP-589, *Software Conventions for Streaming SIMD Extensions*, order number 243873, for details on the stack frame layout that the compiler generates for both debug and optimized ("release"-mode) compilations.

The `__declspec(align(16))` specifications can be placed before data declarations to force 16-byte alignment. This is particularly useful for local or global data declarations that are assigned to Streaming SIMD Extensions data types. The syntax for it is

```
__declspec(align(integer-constant))
```

where the *integer-constant* is an integral power of two but no greater than 32. For example, the following increases the alignment to 16-bytes:

```
__declspec(align(16)) float buffer[400];
```

The variable `buffer` could then be used as if it contained 100 objects of type `__m128` or `F32vec4`. In the code below, the construction of the `F32vec4` object, `x`, will occur with aligned data.

```
void foo() {  
    F32vec4 x = *(__m128 *) buffer;  
    ...  
}
```

Without the declaration of `__declspec(align(16))`, a fault may occur.

**Alignment by Using a `union` Structure.** Preferably, when feasible, a `union` can be used with Streaming SIMD Extensions data types to allow the compiler to align the data structure by default. Doing so is preferred to forcing alignment with `__declspec(align(16))` because it exposes the true program intent to the compiler in that `__m128` data is being used. For example:

```
union {
    float f[400];
    __m128 m[100];
} buffer;
```

The 16-byte alignment is used by default due to the `__m128` type in the `union`; it is not necessary to use `__declspec(align(16))` to force it. In C++ (but not in C) it is also possible to force the alignment of a `class/struct/union` type, as in the code that follows:

```
struct __declspec(align(16)) my_m128
{
    float f[4];
};
```

But, if the data in such a `class` is going to be used with the Streaming SIMD Extensions, it is preferable to use a `union` to make this explicit. In C++, an anonymous `union` can be used to make this more convenient:

```
class my_m128 {
    union {
        __m128 m;
        float f[4];
    };
};
```

In this example, because the `union` is anonymous, the names, `m` and `f`, can be used as immediate member names of `my_m128`. Note that `__declspec(align)` has no effect when applied to a `class`, `struct`, or `union` member in either C or C++.

**Alignment by Using `__m64` or `double` Data.** In some cases, for better performance, the compiler will align routines with `__m64` or `double` data to 16-bytes by default. The command-line switch, `-Qsfalign16`, can be used to limit the compiler to only align in routines that contain Streaming SIMD Extensions data. The default behavior is to use `-Qsfalign8`, which instructs to align routines with 8- or 16-byte data types to 16-bytes.

For more details, see the Intel application note AP-833, *Data Alignment and Programming Issues with the Intel C/C++ Compiler*, order number 243872, and *Intel C/C++ Compiler for Windows32 Systems User's Guide*, order number 718195.

## Improving Memory Utilization

Memory performance can be improved by rearranging data and algorithms for Streaming SIMD Extensions and MMX technology intrinsics. The methods for improving memory performance involve working with the following:

- Data structure layout
- Strip-mining for vectorization and memory utilization
- Loop-blocking

Using the cacheability instructions, prefetch and streaming store, also greatly enhance memory utilization. For these instructions, see Chapter 6, "[Optimizing Cache Utilization for Pentium® III Processors](#)."

## Data Structure Layout

For certain algorithms, like 3D transformations and lighting, there are two basic ways of arranging the vertices data. The traditional method is the array of structures (AoS) arrangement, with a structure for each vertex. However this method does not take full advantage of the Streaming SIMD Extensions SIMD capabilities. The best processing method for code using Streaming SIMD Extensions is to arrange the data in an array for each coordinate. This data arrangement is called structure of arrays (SoA). This arrangement allows more efficient use of the parallelism of Streaming SIMD Extensions because the data is ready for transformation. Another advantage of this arrangement is reduced memory traffic, because only the

relevant data is loaded into the cache. Data that is not relevant for the transformation (such as: texture coordinates, color, and specular) is not loaded into the cache.

There are two options for transforming data in AoS format. One is to perform SIMD operations on the original AoS format. However, this option requires more calculations. In addition, some of the operations do not take advantage of the four SIMD elements in the Streaming SIMD Extensions. Therefore, this option is less efficient. The recommended way for transforming data in AoS format is to temporarily transpose each set of four vertices to SoA format before processing it with Streaming SIMD Extensions.

The following is a simplified transposition example:

**Original format:**

x1,y1,z1 x2,y2,z2 x3,y3,z3 x4,y4,z4

**Transposed format:**

x1,x2,x3,x4 y1,y2,y3,y4 z1,z2,z3,z4

The data structures for the methods are presented, respectively, in Example 3-10 and Example 3-11.

#### **Example 3-10 AoS data structure**

---

```
typedef struct{
    float x,y,z;
    int color;
    . . .
} Vertex;
Vertex Vertices[NumOfVertices];
```

---

#### **Example 3-11 SoA data structure**

---

```
typedef struct{
    float x[NumOfVertices];
    float y[NumOfVertices];
    float z[NumOfVertices];
    int color[NumOfVertices];
    . . .
} VerticesList;
VerticesList Vertices;
```

---

The transposition methods also apply to MMX technology. Consider a simple example of adding a 16-bit bias to all the 16-bit elements of a vector. In regular scalar code, you would load the bias into a register at the beginning of the loop, access the vector elements in another register, and do the addition of one element at a time.

Converting this routine to MMX technology code, you would expect a four times speedup since MMX instructions can process four elements of the vector at a time using the `movq` instruction, and can perform four additions at a time using the `paddw` instruction. However, to achieve the expected speedup, you would need four contiguous copies of the bias in an MMX technology register when adding.

In the original scalar code, only one copy of the bias is in memory. To use MMX instructions, you could use various manipulations to get four copies of the bias in an MMX technology register. Or you could format your memory in advance to hold four contiguous copies of the bias. Then, you need only load these copies using one `MOVQ` instruction before the loop, and the four times speedup is achieved.

Additionally, when accessing SIMD data with SIMD operations, access to data can be improved simply by a change in the declaration. For example, consider a declaration of a structure that represents a point in space. The structure consists of three 16-bit values plus one 16-bit value for padding:

```
typedef struct { short x,y,z; short junk; } Point;
Point pt[N];
```

In the following code the second dimension `y` needs to be multiplied by a scaling value. Here the `for` loop accesses each `y` dimension in the `pt` array:

```
for (i=0; i<N; i++) pt[i].y *= scale;
```

The access is not to contiguous data, which can cause a significant number of cache misses and degrade the application performance.

However, if the data is declared as

```
short ptx[N], pty[N], ptz[N];
for (i=0; i<N; i++) pty[i] *= scale;
```

the scaling operation can be vectorized.

With the MMX technology intrinsics and Streaming SIMD Extensions, data organization becomes more important and should be based on the operations to be performed on the data. In some applications, traditional data arrangements may not lead to the maximum performance.

### Strip Mining

Strip mining, also known as loop sectioning, is a loop transformation technique for enabling SIMD-encodings of loops, as well as providing a means of improving memory performance. This technique, first introduced for vectorizers, is the generation of code when each vector operation is done for a size less than or equal to the maximum vector length on a given vector machine. By fragmenting a large loop into smaller segments or strips, this technique transforms the loop structure twofold:

- It increases the temporal and spatial locality in the data cache if the data are reusable in different passes of an algorithm.
- It reduces the number of loop iterations by the length of each “vector,” or number of operations being performed per SIMD operation. In the case of Streaming SIMD Extensions, this vector or strip-length is reduced by 4 times: four floating-point data items per single Streaming SIMD Extensions operation are processed. Consider Example 3-12.

#### Example 3-12 Pseudo-code Before Strip Mining

---

```
typedef struct _VERTEX {
    float x, y, z, nx, ny, nz, u, v;
} Vertex_rec;
main()
{
    Vertex_rec v[Num];
    ....
    for (i=0; i<Num; i++) {
        Transform(v[i]);
    }
    for (i=0; i<Num; i++) {
        Lighting(v[i]);
    }
    ....
}
```

---



The main loop consists of two functions: transformation and lighting. For each object, the main loop calls a transformation routine to update some data, then calls the lighting routine to further work on the data. If the transformation loop uses only part of the data, say  $x, y, z, u, v$ , and the lighting routine accesses only the other pieces of the structure ( $nx, ny, nz$ , for example), the same cache line is accessed twice in the main loop. This situation is called *false sharing*.

However, by applying strip-mining or loop-sectioning techniques, the number of cache misses due to false sharing can be minimized. As shown in Example 3-3, the original object loop is strip-mined into a two-level nested loop with respect to a selected strip length (`strip_size`). The strip-length should be chosen so that the total size of the strip is smaller than the cache size. As a result of this transformation, the data brought in by the transformation loop will not be evicted from the cache before it can be reused in the lighting routine. See Example 3-13.

### Example 3-13 A Strip Mining Code

---

```
main()
{
    Vertex_rec v[Num];
    ....
    epilogue_num = Num % strip_size;
    for (i=0; i < Num; i+=strip_size) {
        for (j=i; j < min(Num, i+strip_size); j++) {
            Transform(v[j]);
            Lighting(v[j]);
        }
    }
}
```

---

## Loop Blocking

Loop blocking is another useful technique for memory performance optimization. The main purpose of loop blocking is also to eliminate as many cache misses as possible. This technique transforms the memory domain of a given problem into smaller chunks rather than sequentially traversing through the entire memory domain. Each chunk should be small enough to fit all the data for a given computation into the cache, thereby maximizing data reuse. In fact, one can treat loop blocking as strip mining in two dimensions. Consider the code in Example 3-16 and access pattern in Figure 3-3. The two-dimensional array **A** is referenced in the **j** (column) direction and then referenced in the **i** (row) direction; whereas array **B** is referenced in the opposite manner. Assume the memory layout is in column-major order; therefore, the access strides of array **A** and **B** for the code in Example 3-14 would be 1 and **N**, respectively.

### Example 3-14 Loop Blocking

---

#### A. Original loop

```
float A[MAX, MAX], B[MAX, MAX]
for (i=0; i< MAX; i++) {
    for (j=0; j< MAX; j++) {
        A[i,j] = A[i,j] + B[j, i];
    }
}
```

#### B. Transformed Loop after Blocking

```
float A[MAX, MAX], B[MAX, MAX];
for (i=0; i< MAX; i+=block_size) {
    for (j=0; j< N; j+=block_size) {
        for (ii=i; ii<i+block_size; ii++) {
            for (jj=j; jj<j+block_size; jj++) {
                A[ii,jj] = A[ii,jj] + B[jj, ii];
            }
        }
    }
}
```

---

For the first iteration of the inner loop, each access to array **B** will generate a cache miss. If the size of one row of array **A**, that is, `A[2, 0:MAX-1]`, is large enough, by the time the second iteration starts, each access to array **B** will always generate a cache miss. For instance, on the first iteration, the cache line containing `B[0, 0:7]` will be brought in when `B[0,0]` is referenced because the `float` type variable is four bytes and each cache line is 32 bytes. Due to the limitation of cache capacity, this line will be evicted due to conflict misses before the inner loop reaches the end. For the next iteration of the outer loop, another cache miss will be generated while referencing `B[0,1]`. In this manner, a cache miss occurs when each element of array **B** is referenced, that is, there is no data reuse in the cache at all for array **B**.

This situation can be avoided if the loop is blocked with respect to the cache size. In Figure 3-3, a `block_size` is selected as the loop blocking factor. Suppose that `block_size` is 8, then the blocked chunk of each array will be eight cache lines (32 bytes each). In the first iteration of the inner loop, `A[0, 0:7]` and `B[0, 0:7]` will be brought into the cache. `B[0, 0:7]` will be completely consumed by the first iteration of the outer loop. Consequently, `B[0, 0:7]` will only experience one cache miss after applying loop blocking optimization in lieu of eight misses for the original algorithm. As illustrated in Figure 3-3, arrays **A** and **B** are blocked into smaller rectangular chunks so that the total size of two blocked **A** and **B** chunks is smaller than the cache size. This allows maximum data reuse.

**Figure 3-3 Loop Blocking Access Pattern**

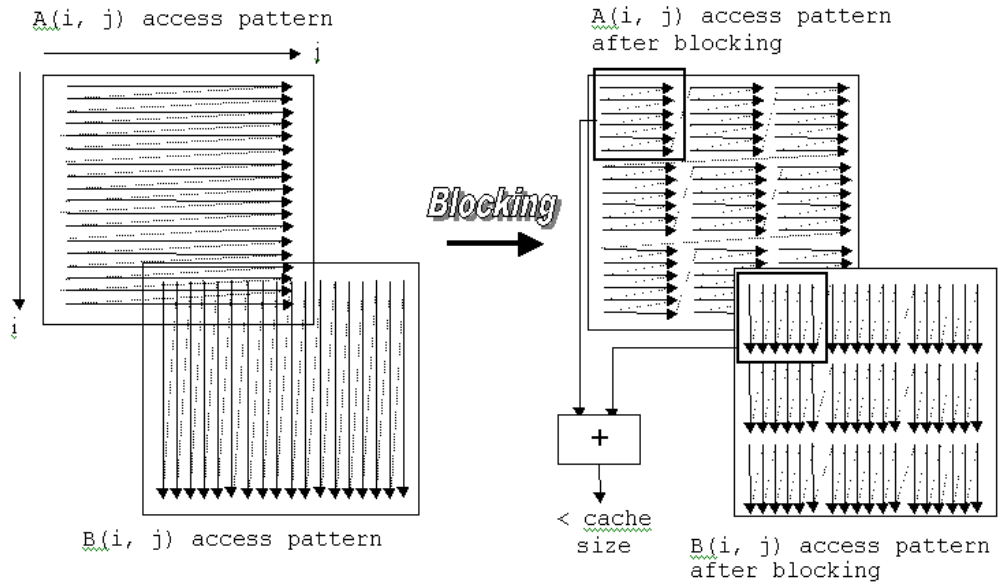

As one can see, all the redundant cache misses can be eliminated by applying this loop blocking technique. If MAX is huge, loop blocking can also help reduce the penalty from DTLB (data translation look-ahead buffer) misses. In addition to improving the cache/memory performance, this optimization technique also saves external bus bandwidth.

## Tuning the Final Application

The best way to tune your application once it is functioning correctly is to use a profiler that measures the application while it is running on a system. Intel's VTune analyzer can help you determine where to make changes in your application to improve performance. Using the VTune analyzer can help you with various phases required for optimized performance. See \_

[“VTune™ Performance Analyzer” in Chapter 7](#) for more details on using the VTune analyzer. After every effort to optimize, you should check the performance gains to see where you are making your major optimization gains.



# Using SIMD Integer Instructions

---

# 4

The SIMD integer instructions provide performance improvements in applications that are integer-intensive and can take advantage of the SIMD architecture of Pentium® II and Pentium III processors.

The guidelines for using these instructions in addition to the guidelines described in Chapter 2, “[General Optimization Guidelines](#)” will help develop fast and efficient code that scales well across all processors with MMX™ technology, as well as the Pentium II and Pentium III processors that use Streaming SIMD Extensions (SSE) with the new SIMD integer instructions.

## General Rules on SIMD Integer Code

The overall rules and suggestions are as follows:

- Do not intermix MMX instructions, new SIMD integer instructions, and floating-point instructions. See “[Using SIMD Integer, Floating-Point, and MMX™ Technology Instructions](#)” section.
- All optimization rules and guidelines described in Chapters 2 and 3 that apply to both Pentium II and Pentium III processors using the new SIMD integer instructions.

## Planning Considerations

The planning considerations discussed in [“Considerations for Code Conversion to SIMD Programming”](#) in Chapter 3, apply when considering using the new SIMD integer instructions available with the Streaming SIMD Extensions.

Applications that benefit from these new instructions include video encoding and decoding, as well as speech processing. Many existing applications may also benefit from some of these new instructions, particularly if they use MMX technology.

Review the planning considerations in the cited above section in Chapter 3 to determine if an application is computationally integer-intensive and can take advantage of the SIMD architecture. If any of the considerations discussed in Chapter 3 apply, the application is a candidate for performance improvements using the new Pentium III processor SIMD integer instructions, or MMX technology.

## CPUID Usage for Detection of Pentium® III Processor SIMD Integer Instructions

Applications must be able to determine if Streaming SIMD Extensions are available. Follow the guidelines outlined in section [“Checking for Processor Support of Streaming SIMD Extensions and MMX™ Technology”](#) in Chapter 3 to identify whether a system (processor and operating system) supports the Streaming SIMD Extensions.

## Using SIMD Integer, Floating-Point, and MMX™ Technology Instructions

The same rules and considerations for mixing MMX technology and floating-point instructions apply for Pentium III processor SIMD integer instructions. The Pentium III processor SIMD integer instructions use the MMX technology registers, which are mapped onto the floating-point registers. Thus, mixing Pentium III processor SIMD integer or MMX



instructions with floating-point instructions is not recommended. Pentium III processor SIMD integer and MMX instructions, however, can be intermixed with no transition required.

## Using the EMMS Instruction

When generating MMX technology code, keep in mind that the eight MMX technology registers are aliased on the floating-point registers. Switching from MMX instructions to floating-point instructions can take up to fifty clock cycles, so it is the best to minimize switching between these instruction types. But when you need to switch, you need to use a special instruction known as the `emms` instruction.

Using `emms` is like emptying a container to accommodate new content. For example, MMX instructions automatically enable a tag word in the register to validate the use of the `__m64` datatype. This validation resets the FP register to enable its alias as an MMX technology register. To enable an FP instruction again, reset the register state with the `emms` instruction `_m_empty()` as illustrated in Figure 4-1.

**Figure 4-1 Using EMMS to Reset the Tag after an MMX Instruction**

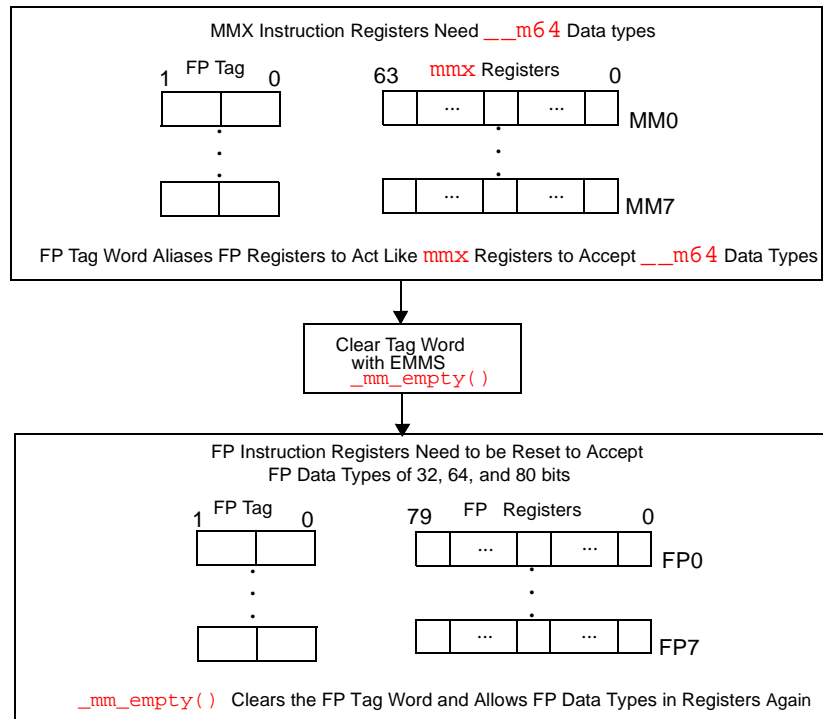

**CAUTION.** Failure to reset the tag word for FP instructions after using an MMX instruction can result in faulty execution or poor performance.

## Guidelines for Using EMMS Instruction

When writing an application that uses both floating-point and MMX instructions, use the following guidelines to help you determine when to use

`emms`:

- *If next instruction is FP*—Use `_mm_empty()` after an MMX instruction if the next instruction is an FP instruction; for example, before doing calculations on floats, doubles or long doubles.
- *Don't empty when already empty*—If the next instruction uses an MMX register, `_mm_empty()` incurs an operation with no benefit (no-op).
- *Group Instructions*—Use different functions for regions that use FP instructions and those that use MMX instructions. This eliminates needing an EMMS instruction within the body of a critical loop.
- *Runtime initialization*—Use `_mm_empty()` during runtime initialization of `__m64` and FP data types. This ensures resetting the register between data type transitions. See Example 4-1 for coding usage.

### Example 4-1 Resetting the Register between `__m64` and FP Data Types

#### Incorrect Usage

```
__m64 x = _m_padd(y, z);
float f = init();
```

#### Correct Usage

```
__m64 x = _m_padd(y, z);
float f = (_mm_empty(), init());
```

Further, you must be aware of the following situations when your code generates an MMX instruction which uses the MMX technology registers with the Intel C/C++ Compiler:

- when using an MMX technology intrinsic
- when using a Streaming SIMD Extension (for those intrinsics that use MMX technology data)
- when using an MMX instruction through inline assembly
- when referencing an `__m64` data type variable

When developing code with both floating-point and MMX instructions, follow these steps:

1. Always call the `emms` instruction at the end of MMX technology code when the code transitions to x87 floating-point code.
2. Insert this instruction at the end of all MMX technology code segments to avoid an overflow exception in the floating-point stack when a floating-point instruction is executed.
3. Use the `emms` instruction to clear the MMX technology registers and set the value of the floating-point tag word to empty (that is, all ones). Since the Pentium III processor SIMD integer instructions use the MMX technology registers, which are aliased on the floating-point registers, it is critical to clear the MMX technology registers before issuing a floating-point instruction.

The `emms` instruction does not need to be executed when transitioning between SIMD floating-point and MMX technology or Streaming SIMD Extensions SIMD integer instructions or `x87` floating-point instructions. Additional information on the floating-point programming model can be found in the *Pentium Processor Family Developer's Manual*, Volume 3, Architecture and Programming, order number 241430. For more documentation on `emms`, visit the <http://developer.intel.com> web site.

## Data Alignment

Make sure your data is 16-byte aligned. Refer to section [“Stack and Data Alignment” in Chapter 3](#) for information on both Pentium II and Pentium III processors. Review this information to evaluate your data. If the data is known to be unaligned, use `movups` (move unaligned packed single precision) to avoid a general protection exception if `movaps` is used.

## SIMD Integer and SIMD Floating-point Instructions

SIMD integer instructions and SIMD floating-point instructions can be intermixed with some restrictions. These restrictions result from their respective port assignments. Port assignments are shown in Appendix C. The port assignments for the relevant instructions are shown in Table 4-1.

**Table 4-1 Port Assignments**

Port 0	Port 1
<code>pmulhuw</code>	<code>pshufw</code>
<code>pmin</code>	<code>pextrw</code>
<code>pmax</code>	<code>pinsrw</code>
<code>psadw</code>	<code>pmin</code>
<code>pavgw</code>	<code>pmax</code>
	<code>pmovmskb</code>
	<code>psadw</code>
	<code>pavgw</code>

### SIMD Instruction Port Assignments

All the above instructions incur one  $\mu\text{op}$  with the exception of `psadw`, which incurs three  $\mu\text{ops}$ , and `pinsrw`, which incurs two  $\mu\text{ops}$ . Note that some instructions, such as `pmin` and `pmax`, can execute on both ports.

These instructions can be intermixed with the SIMD floating-point instructions. Since the SIMD floating-point instructions are two  $\mu\text{ops}$ , intermix those with different port assignments from the current instruction (see Appendix C, “[Instruction to Decoder Specification](#)”).

### Coding Techniques for MMX Technology SIMD Integer Instructions

This section contains several simple examples that will help you to get started with coding your application. The goal is to provide simple, low-level operations that are frequently used. The examples use a minimum number of instructions necessary to achieve best performance on the Pentium, Pentium Pro, Pentium II, and Pentium III processors.

Each example includes a short description, sample code, and notes if necessary. These examples do not address scheduling as it is assumed the examples will be incorporated in longer code sequences.

## Unsigned Unpack

The MMX technology provides several instructions that are used to pack and unpack data in the MMX technology registers. The unpack instructions can be used to zero-extend an unsigned number. Example 4-2 assumes the source is a packed-word (16-bit) data type.

### Example 4-2 Unsigned Unpack Instructions

---

```
; Input:  MM0          source value
;         MM7 0       a local variable can be used
;                   instead of the register MM7 if
;                   desired.
; Output: MM0          two zero-extended 32-bit
;                   doublewords from two low-end
;                   words
;         MM1          two zero-extended 32-bit
;                   doublewords from two high-end
;                   words

movq     MM7, MM0 ; copy source
punpcklwd MM0, MM7 ; unpack the 2 low-end words
;                ; into two 32-bit doubleword
punpckhwd MM1, MM7 ; unpack the 2 high-end words
;                ; into two 32-bit doublewords
```

---

## Signed Unpack

Signed numbers should be sign-extended when unpacking the values. This is done differently than the zero-extend shown above. Example 4-3 assumes the source is a packed-word (16-bit) data type.

---

**Example 4-3 Signed Unpack Instructions**

---

```
; Input: MM0          source value
; Output: MM0         two sign-extended 32-bit
;                    doublewords from the two low-end
;                    words
;
;                    MM1   two sign-extended 32-bit
;                    doublewords from the two high-end
;                    words
movq    MM1, MM0 ; copy source
punpckhwdMM1, MM0 ; unpack the 2 high-end words of the
; source into the second and fourth
; words of the destination
punpcklwdMM0, MM0 ; unpack the 2 low end words of the
; source into the second and fourth
; words of the destination
psrad   MM0, 16 ; sign-extend the 2 low-end words of
; the source into two 32-bit signed
; doublewords
psrad   MM1, 16 ; sign-extend the 2 high-end words
; of the source into two 32-bit
; signed doublewords
```

---

**Interleaved Pack with Saturation**

The pack instructions pack two values into the destination register in a predetermined order. Specifically, the `packssdw` instruction packs two signed doublewords from the source operand and two signed doublewords from the destination operand into four signed words in the destination register as shown in Figure 4-2.

**Figure 4-2** `PACKSSDW mm, mm/mm64` Instruction Example

---

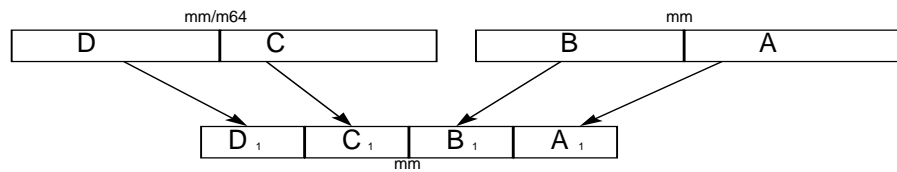
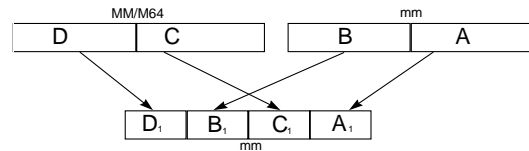

Figure 4-3 illustrates two values interleaved in the destination register. The two signed doublewords are used as source operands and the result is interleaved signed words. The pack instructions can be performed with or without saturation as needed.

**Figure 4-3** `Interleaved Pack with Saturation`

---



Example 4-4 uses signed doublewords as source operands and the result is interleaved signed words. The pack instructions can be performed with or without saturation as needed.



---

**Example 4-4 Interleaved Pack with Saturation**

---

```
; Input: MM0   signed source1 value
;           MM1   signed source2 value
; Output:MM0   the first and third words contain the
;             signed-saturated doublewords from MM0,
;             the second and fourth words contain
;             signed-saturated doublewords from MM1

packssdw  MM0, MM0 ; pack and sign saturate
packssdw  MM1, MM1 ; pack and sign saturate
punpcklwd MM0, MM1 ; interleave the low-end 16-bit
                  ; values of the operands
```

---

The pack instructions always assume that the source operands are signed numbers. The result in the destination register is always defined by the pack instruction that performs the operation. For example, the `packssdw` instruction packs each of the two signed 32-bit values of the two sources into four saturated 16-bit signed values in the destination register. The `packuswb` instruction, on the other hand, packs each of the four signed 16-bit values of the two sources into four saturated eight-bit unsigned values in the destination. A complete specification of the MMX instruction set can be found in the *Intel Architecture MMX Technology Programmer's Reference Manual*, order number 243007.

**Interleaved Pack without Saturation**

Example 4-5 is similar to the last except that the resulting words are not saturated. In addition, in order to protect against overflow, only the low order 16 bits of each doubleword are used in this operation.

## Example 4-5 Interleaved Pack without Saturation

```

; Input: MM0    signed source value
;           MM1    signed source value

; Output:MM0    the first and third words contain the
;               low 16-bits of the doublewords in MM0,
;               the second and fourth words contain the
;               low 16-bits of the doublewords in MM1

pslld    MM1, 16 ; shift the 16 LSB from each of the
                ; doubleword values to the 16 MSB
                ; position
pand     MM0, {0,ffff,0,ffff} ; mask to zero the 16 MSB
                ; of each doubleword value
por      MM0, MM1             ; merge the two operands

```

## Non-Interleaved Unpack

The unpack instructions perform an interleave merge of the data elements of the destination and source operands into the destination register. The following example merges the two operands into the destination registers without interleaving. For example, take two adjacent elements of a packed-word data type in `source1` and place this value in the low 32 bits of the results. Then take two adjacent elements of a packed-word data type in `source2` and place this value in the high 32 bits of the results. One of the destination registers will have the combination illustrated in Figure 4-4.

Figure 4-4 Result of Non-Interleaved Unpack in MM0

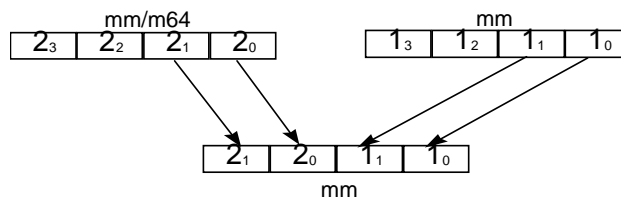

The other destination register will contain the opposite combination illustrated in Figure 4-5.

**Figure 4-5 Result of Non-Interleaved Unpack in MM1**

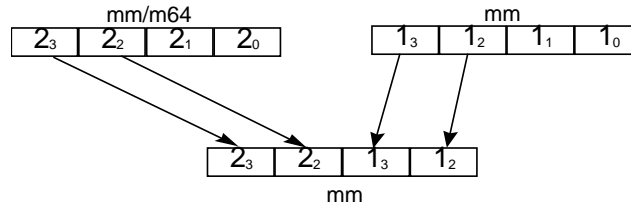

Code in the Example 4-6 unpacks two packed-word sources in a non-interleaved way. The goal is to use the instruction which unpacks doublewords to a quadword, instead of using the instruction which unpacks words to doublewords.

**Example 4-6 Unpacking Two Packed-word Sources in a Non-interleaved Way**

```

; Input: MM0  packed-word source value
;         MM1  packed-word source value
; Output: MM0 contains the two low-end words of the
;         original sources, non-interleaved
;         MM2 contains the two high end words of the
;         original sources, non-interleaved.
movq    MM2, MM0 ; copy source1
punpckldq MM0, MM1 ; replace the two high-end words
                   ; of MM0 with two low-end words of
                   ; MM1; leave the two low-end words
                   ; of MM0 in place
punpckhdq MM2, MM1 ; move two high-end words of MM2
                   ; to the two low-end words of MM2;
                   ; place the two high-end words of
                   ; MM1 in two high-end words of MM2

```

## Complex Multiply by a Constant

Complex multiplication is an operation which requires four multiplications and two additions. This is exactly how the `pmaddwd` instruction operates. In order to use this instruction, you need to format the data into four 16-bit values. The real and imaginary components should be 16-bits each.

Consider Example 4-7:

- Let the input data be `Dr` and `Di` where `Dr` is real component of the data and `Di` is imaginary component of the data.
- Format the constant complex coefficients in memory as four 16-bit values [`Cr -Ci Cr`]. Remember to load the values into the MMX technology register using a `movq` instruction.
- The real component of the complex product is

$$Pr = Dr*Cr - Di*Ci$$

and the imaginary component of the complex product is

$$Pi = Dr*Ci + Di*Cr.$$

### Example 4-7 Complex Multiply by a Constant

---

```

; Input: MM0  complex value, Dr, Di
;         MM1  constant complex coefficient in the form
;         [Cr -Ci Cr]
; Output: MM0  two 32-bit dwords containing [Pr Pi]
punpckldq   MM0, MM0 ; makes [Dr Di Dr Di]
pmaddwd     MM0, MM1 ; done, the result is
; [(Dr*Cr-Di*Ci)(Dr*Ci+Di*Cr)]

```

---

Note that the output is a packed doubleword. If needed, a pack instruction can be used to convert the result to 16-bit (thereby matching the format of the input).

## Absolute Difference of Unsigned Numbers

Example 4-8 computes the absolute difference of two unsigned numbers. It assumes an unsigned packed-byte data type. Here, we make use of the subtract instruction with unsigned saturation. This instruction receives

**UNSIGNED** operands and subtracts them with **UNSIGNED** saturation. This support exists only for packed bytes and packed words, not for packed dwords.

### Example 4-8 Absolute Difference of Two Unsigned Numbers

```

; Input: MM0  source operand
;        MM1  source operand
; Output: MM0 absolute difference of the unsigned
;          operands

movq    MM2, MM0 ; make a copy of MM0
psubusb MM0, MM1 ; compute difference one way
psubusb MM1, MM2 ; compute difference the other way
por     MM0, MM1 ; OR them together

```

This example will not work if the operands are signed.

### Absolute Difference of Signed Numbers

Example 4-9 computes the absolute difference of two signed numbers.



**NOTE.** *There is no MMX technology subtract instruction that receives **SIGNED** operands and subtracts them with **UNSIGNED** saturation.*

The technique used here is to first sort the corresponding elements of the input operands into packed-words of the maximum values, and packed-words of the minimum values. Then the minimum values are subtracted from the maximum values to generate the required absolute difference. The key is a fast sorting technique that uses the fact that  $B = \text{xor}(A, \text{xor}(A, B))$  and  $A = \text{xor}(A, 0)$ . Thus in a packed data type, having some elements being  $\text{xor}(A, B)$  and some being 0, you could  $\text{xor}$  such an operand with  $A$  and receive in some places values of  $A$  and in some values of  $B$ . The following examples assume a packed-word data type, each element being a signed value.

**Example 4-9 Absolute Difference of Signed Numbers**

---

```
; Input: MM0 signed source operand
;        MM1 signed source operand
;Output: MM0 absolute difference of the unsigned
;        operands

movq     MM2, MM0    ; make a copy of source1 (A)
pcmpgtw MM0, MM1    ; create mask of source1>source2
                    ; (A>B)
movq     MM4, MM2    ; make another copy of A
pxor     MM2, MM1    ; create the intermediate value of
                    ; the swap operation - xor(A,B)
pand     MM2, MM0    ; create a mask of 0s and xor(A,B)
                    ; elements. Where A>B there will
                    ; be a value xor(A,B) and where
                    ; A<=B there will be 0.
pxor     MM4, MM2    ; minima-xor(A,swap mask)
pxor     MM1, MM3    ; maxima-xor(B, swap mask)
psubw   MM1, MM4    ; absolute difference =
                    ; maxima-minima
```

---

## Absolute Value

Use Example 4-10 to compute  $|x|$ , where  $x$  is signed. This example assumes signed words to be the operands.

### Example 4-10 Computing Absolute Value

---

```
; Input: MM0 signed source operand
; Output: MM1 ABS(MM0)

movq   MM1, MM0    ; make a copy of x
psraw  MM0, 15     ; replicate sign bit (use 31 if doing
                  ; DWORDS)
pxor   MM0, MM1    ; take 1's complement of just the
                  ; negative fields
psubs  MM1, MM0    ; add 1 to just the negative fields
```

---



---

**CAUTION.** *The absolute value of the most negative number (that is, 8000 hex for 16-bit) does not fit, but this code suggests what is possible to do for this case: it gives 0x7fff which is off by one.*

---

## Clipping to an Arbitrary Signed Range [high, low]

This section explains how to clip a signed value to the signed range [high, low]. Specifically, if the value is less than low or greater than high then clip to low or high, respectively. This technique uses the packed-add and packed-subtract instructions with unsigned saturation, which means that this technique can only be used on packed-byte and packed-word data types.

Example 4-11 and Example 4-12 in this section use the constants `packed_max` and `packed_min` and show operations on word values. For simplicity we use the following constants (corresponding constants are used in case the operation is done on byte values):

- `packed_max` equals `0x7fff7fff7fff7fff`
- `packed_min` equals `0x8000800080008000`
- `packedD_low` contains the value `low` in all four words of the packed-words data type
- `packed_high` contains the value `high` in all four words of the packed-words data type
- `packed_usmax` all values equal 1
- `high_us` adds the `high` value to all data elements (4 words) of `packed_min`
- `low_us` adds the `low` value to all data elements (4 words) of `packed_min`

---

#### Example 4-11 Clipping to an Arbitrary Signed Range [high, low]

---

```

; Input: MM0  signed source operands
; Output: MM1 signed operands clipped to the unsigned
;          range [high, low]

padd      MM0, packed_min ; add with no saturation
                        ; 0x8000 to convert to unsigned
paddusw   MM0, (packed_usmax - high_us)
                        ; in effect this clips to high
psubusw   MM0, (packed_usmax - high_us + low_us)
                        ; in effect this clips to low
paddw     MM0, packed_low ; undo the previous two offsets

```

---

The code above converts values to unsigned numbers first and then clips them to an unsigned range. The last instruction converts the data back to signed data and places the data within the signed range. Conversion to unsigned data is required for correct results when  $(high - low) < 0x8000$ .



If  $(\text{high} - \text{low}) \geq 0x8000$ , the algorithm can be simplified as shown in Example 4-12:

### Example 4-12 Simplified Clipping to an Arbitrary Signed Range

```

; Input: MM0 signed source operands
; Output: MM1 signed operands clipped to the unsigned
;         range [high, low]

paddssw    MM0, (packed_max - packed_high)
           ; in effect this clips to high
psubssw    MM0, (packed_usmax - packed_high +
packed_ow);
           ; clips to low
paddw     MM0, low    ; undo the previous two offsets

```

This algorithm saves a cycle when it is known that  $(\text{high} - \text{low}) \geq 0x8000$ . The three-instruction algorithm does not work when  $(\text{high} - \text{low}) < 0x8000$ , because  $0xffff$  minus any number  $< 0x8000$  will yield a number greater in magnitude than  $0x8000$ , which is a negative number. When the second instruction,

```
psubssw MM0, (0xffff - high + low),
```

in the three-step algorithm (Example 4-12) is executed, a negative number is subtracted. The result of this subtraction causes the values in `MM0` to be increased instead of decreased, as should be the case, and an incorrect answer is generated.

### Clipping to an Arbitrary Unsigned Range [high, low]

The code in Example 4-13 clips an unsigned value to the unsigned range `[high, low]`. If the value is less than `low` or greater than `high`, then clip to `low` or `high`, respectively. This technique uses the packed-add and packed-subtract instructions with unsigned saturation, thus this technique can only be used on packed-bytes and packed-words data types.

The example illustrates the operation on word values.

**Example 4-13 Clipping to an Arbitrary Unsigned Range [high, low]**

---

```

; Input: MM0  unsigned source operands
;Output: MM1  unsigned operands clipped to the unsigned
;            range [HIGH, LOW] //
paddusw     MM0, 0xffff - high
            ; in effect this clips to high
psubusw     MM0, (0xffff - high + low)
            ; in effect this clips to low
paddw       MM0, low
            ; undo the previous two offsets

```

---

**Generating Constants**

The MMX instruction set does not have an instruction that will load immediate constants to MMX technology registers. The following code segments generate frequently used constants in an MMX technology register. Of course, you can also put constants as local variables in memory, but when doing so be sure to duplicate the values in memory and load the values with a `movq` instruction, see Example 4-14.

**Example 4-14 Generating Constants**

---

```

pxor  MM0, MM0    ; generate a zero register in MM0
pcmpeq MM1, MM1  ; Generate all 1's in register MM1,
                 ; which is -1 in each of the packed
                 ; data type fields

pxor  MM0, MM0
pcmpeq MM1, MM1
psubb MM0, MM1 [psubb MM0, MM1] (psubd MM0, MM1)

```

---

continued

**Example 4-14 Generating Constants (continued)**

```

; three instructions above generate
; the constant 1 in every
; packed-byte [or packed-word]
; (or packed-dword) field

pcmpeq MM1, MM1
psrlw MM1, 16-n (psrld MM1, 32-n)

; two instructions above generate
; the signed constant  $2^{n-1}$  in every
; packed-word (or packed-dword) field

pcmpeq MM1, MM1
psllw MM1, n (pslldMM1, n)

; two instructions above generate
; the signed constant  $-2^n$  in every
; packed-word (or packed-dword) field

```



---

**NOTE.** *Because the MMX instruction set does not support shift instructions for bytes,  $2^{n-1}$  and  $-2^n$  are relevant only for packed words and packed dwords.*

---

## Coding Techniques for Integer Streaming SIMD Extensions

This section contains examples of the new SIMD integer instructions. Each example includes a short description, sample code, and notes where necessary.

These short examples, which usually are incorporated in longer code sequences, do not address scheduling.

## Extract Word

The `pextrw` instruction takes the word in the designated MMX technology register selected by the two least significant bits of the immediate value and moves it to the lower half of a 32-bit integer register, see Figure 4-6 and Example 4-15.

**Figure 4-6** `pextrw` Instruction

---

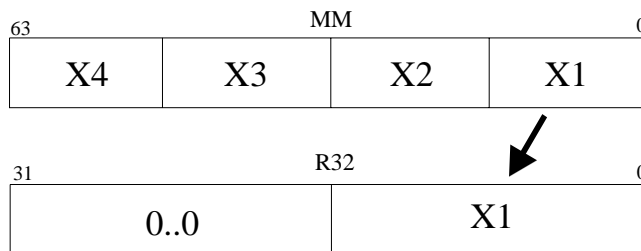

**Example 4-15** `pextrw` Instruction Code

---

```

; Input:  eax source value immediate value:"0"
; Output: edx 32-bit integer register containing the
           extracted word in the low-order bits & the
           high-order bits zero-extended

movq    mm0, [eax]
pextrw  edx, mm0, 0

```

---

## Insert Word

The `pinsrw` instruction loads a word from the lower half of a 32-bit integer register or from memory and inserts it in the MMX technology destination register at a position defined by the two least significant bits of the immediate constant. Insertion is done in such a way that the three other words from the destination register are left untouched, see Figure 4-7 and Example 4-16.

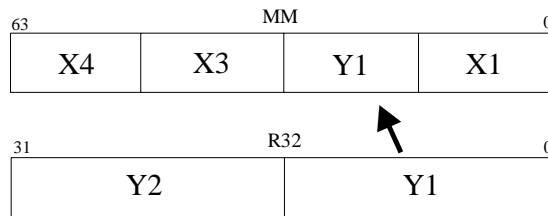
**Figure 4-7 pinsrw Instruction****Example 4-16 pinsrw Instruction Code**

```

; Input:      32-bit integer register: source value
               immediate value: "1".

; Output:     MMX technology register with new 16-bit
               value inserted

movq    mm0, [edx]
pinsrw  mm0, eax, 1

```

## Packed Signed Integer Word Maximum

The `pmaxsw` instruction returns the maximum between the four signed words in either two MMX technology registers, or one MMX technology register and a 64-bit memory location.

## Packed Unsigned Integer Byte Maximum

The `pmaxub` instruction returns the maximum between the eight unsigned bytes in either two MMX technology registers, or one MMX technology register and a 64-bit memory location.

## Packed Signed Integer Word Minimum

The `pminsw` instruction returns the minimum between the four signed words in either two MMX technology registers, or one MMX technology register and a 64-bit memory location.

## Packed Unsigned Integer Byte Minimum

The `pminub` instruction returns the minimum between the eight unsigned bytes in either two MMX technology registers, or one MMX technology register and a 64-bit memory location.

## Move Byte Mask to Integer

The `pmovmskb` instruction returns an 8-bit mask formed from the most significant bits of each byte of its source operand, see Figure 4-8 and Example 4-17.

**Figure 4-8** `pmovmskb` Instruction Example

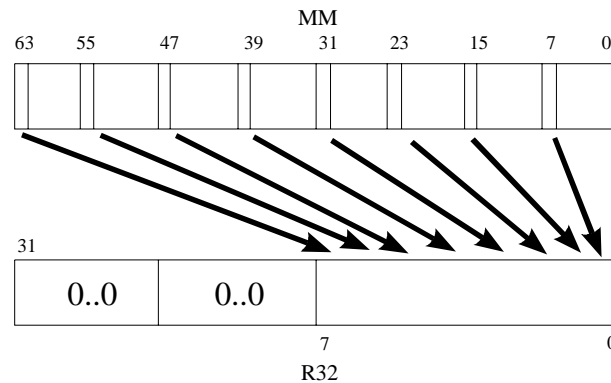

## Example 4-17 `pmovmskb` Instruction Code

```

; Input:      source value
; Output:     32-bit register containing the byte mask
               in the lower eight bits

movq    mm0, [edi]
pmovmskb eax, mm0

```

## Packed Multiply High Unsigned

The `pmulhbw` instruction multiplies the four unsigned words in the destination operand with the four unsigned words in the source operand. The high-order 16 bits of the 32-bit immediate results are written to the destination operand.

## Packed Shuffle Word

The `pshuf` instruction (see Figure 4-9, Example 4-18) uses the immediate (`imm8`) operand to select between the four words in either two MMX technology registers or one MMX technology register and a 64-bit memory location. Bits 1 and 0 of the immediate value encode the source for destination word 0 (`MMX[15-0]`), and so on as shown in the table:

Bits	Word
1 - 0	0
3 - 2	1
5 - 4	2
7 - 6	3

Bits 7 and 6 encode for word 3 (`MMX[63-48]`). Similarly, the 2-bit encoding represents which source word is used, for example, binary encoding of 10 indicates that source word 2 (`MM2/mem[47-32]`) is used, see Example 4-18 and Example 4-18.

**Figure 4-9** `pshuf` Instruction Example

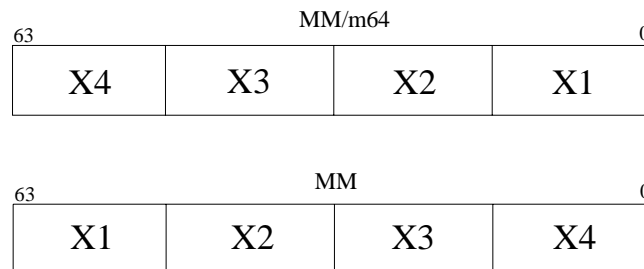

## Example 4-18 pshuf Instruction Code

```

; Input:  edi source value
; Output: MM1 MM register containing the byte mask in
           the lower eight bits

movq mm0, [edi]
pshufw mm1, mm0, 0x1b

```

## Packed Sum of Absolute Differences

The **PSADBQ** instruction (see Figure 4-10) computes the absolute value of the difference of unsigned bytes for either two MMX technology registers, or one MMX technology register and a 64-bit memory location. These differences are then summed to produce a word result in the lower 16-bit field, and the upper three words are set to zero.

Figure 4-10 PSADBQ Instruction Example

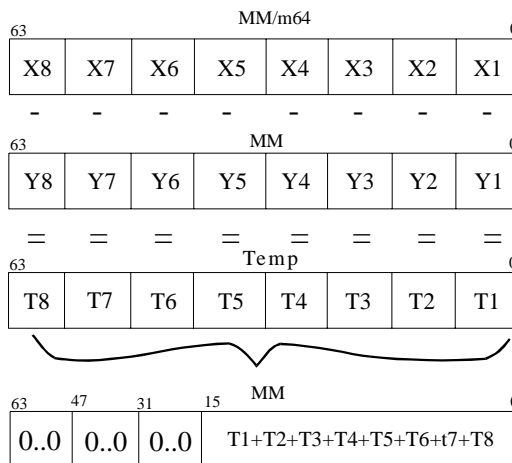



The subtraction operation presented above is an absolute difference, that is,  $t = \text{abs}(x-y)$ . The byte values are stored in temporary space, all values are summed together, and the result is written into the lower word of the destination register.

## Packed Average (Byte/Word)

The `pavgb` and `pavgw` instructions add the unsigned data elements of the source operand to the unsigned data elements of the destination register, along with a carry-in. The results of the addition are then each independently shifted to the right by one bit position. The high order bits of each element are filled with the carry bits of the corresponding sum.

The destination operand is an MMX technology register. The source operand can either be an MMX technology register or a 64-bit memory operand.

The `PAVGB` instruction operates on packed unsigned bytes and the `PAVGW` instruction operates on packed unsigned words.

## Memory Optimizations

You can improve memory accesses using the following techniques:

- Partial Memory Accesses
- Instruction Selection
- Increasing Bandwidth of Memory Fills and Video Fills
- Pre-fetching data with Streaming SIMD Extensions (see Chapter 6, “[Optimizing Cache Utilization for Pentium® III Processors](#)”).

The MMX technology registers allow you to move large quantities of data without stalling the processor. Instead of loading single array values that are 8, 16, or 32 bits long, consider loading the values in a single quadword, then incrementing the structure or array pointer accordingly.

Any data that will be manipulated by MMX instructions should be loaded using either:

- the MMX instruction that loads a 64-bit operand (for example, `movq MM0, m64`)

- the register-memory form of any MMX instruction that operates on a quadword memory operand (for example, `pmaddw MM0, m64`)
- all SIMD data should be stored using the MMX instruction that stores a 64-bit operand (for example, `movq m64, MM0`)

The goal of these recommendations is twofold. First, the loading and storing of SIMD data is more efficient using the larger quadword block sizes. Second, this helps to avoid the mixing of 8-, 16-, or 32-bit load and store operations with 64-bit MMX technology load and store operations to the same SIMD data. This, in turn, prevents situations in which small loads follow large stores to the same area of memory, or large loads follow small stores to the same area of memory. Pentium II and Pentium III processors stall in these situations.

### Partial Memory Accesses

Let's consider a case with large load after a series of small stores to the same area of memory (beginning at memory address `mem`). The large load will stall in this case as shown in Example 4-19.

#### Example 4-19 A Large Load after a Series of Small Stalls

---

```
mov    mem, eax      ; store dword to address "mem"
mov    mem + 4, ebx  ; store dword to address "mem + 4"
      :
      :
movq   mm0, mem      ; load qword at address "mem", stalls
```

---

The `movq` must wait for the stores to write memory before it can access all the data it requires. This stall can also occur with other data types (for example, when bytes or words are stored and then words or doublewords are read from the same area of memory). When you change the code sequence as shown in Example 4-20, the processor can access the data without delay.

**Example 4-20 Accessing Data without Delay**

---

```
movd    mm1, ebx    ; build data into a qword first
                        ; before storing it to memory
movd    mm2, eax
psllq   mm1, 32
por     mm1, mm2
movq    mem, mm1    ; store SIMD variable to "mem" as
                        ; a qword
:
:
movq    mm0, mem    ; load qword SIMD "mem", no stall
```

---

Let us now consider a case with a series of small loads after a large store to the same area of memory (beginning at memory address `mem`). The small loads will stall in this case as shown in Example 4-21.

**Example 4-21 A Series of Small Loads after a Large Store**

---

```
movq    mem, mm0    ; store qword to address "mem"
:
:
mov     bx, mem + 2 ; load word at "mem + 2" stalls
mov     cx, mem + 4; load word at "mem + 4" stalls
```

---

The word loads must wait for the quadword store to write to memory before they can access the data they require. This stall can also occur with other data types (for example, when doublewords or words are stored and then words or bytes are read from the same area of memory). When you change the code sequence as shown in Example 4-22, the processor can access the data without delay.

**Example 4-22 Eliminating Delay for a Series of Small Loads after a Large Store**

---

```
movq    mem, mm0      ; store qword to address "mem"
      :
      :
movq    mm1, mem      ; load qword at address "mem"
movd    eax, mm1      ; transfer "mem + 2" to eax from
                      ; MMX technology register, not
                      ; memory

psrlq  mm1, 32
shr    eax, 16
movd   ebx, mm1      ; transfer "mem + 4" to bx from
                      ; MMX technology register, not
                      ; memory

and    ebx, 0ffffh
```

---

These transformations, in general, increase the number of instructions required to perform the desired operation. For Pentium II and Pentium III processors, the performance penalty due to the increased number of instructions is more than offset by the benefit.

**Instruction Selection to Reduce Memory Access Hits**

An MMX instruction may have two register operands (*OP reg, reg*) or one register and one memory operand (*OP reg, mem*), where *OP* represents the instruction opcode, *reg* represents the register, and *mem* represents memory. *OP reg, mem* instructions are useful in some cases to reduce register pressure, increase the number of operations per cycle, and reduce code size.

The following discussion assumes that the memory operand is present in the data cache. If it is not, then the resulting penalty is usually large enough to obviate the scheduling effects discussed in this section.

In Pentium processors, *OP reg, mem* MMX instructions do not have longer latency than *OP reg, reg* instructions (assuming a cache hit). They do have more limited pairing opportunities, however. In Pentium II and Pentium III processors, *OP reg, mem* MMX instructions translate into

two  $\mu\text{ops}$ , as opposed to one  $\mu\text{op}$  for the `OP reg, reg` instructions. Thus, they tend to limit decoding bandwidth and occupy more resources than `OP reg, reg` instructions.

Recommended usage of `OP reg, mem` instructions depends on whether the MMX technology code is memory bound (that is, execution speed is limited by memory accesses). Generally, an MMX technology code section is considered to be memory-bound if the following inequality is true:

$$\text{Instructions}/2 < \text{Memory Accesses} + \text{non-MMX Instructions}/2$$

For memory-bound MMX technology code, the recommendation is to merge loads whenever the same memory address is used more than once. This reduces the number of memory accesses.

For example,

```
OP MM0, [address A]
OP MM1, [address A]
```

becomes

```
movq MM2, [address A]
OP MM0, MM2
OP MM1, MM2
```

For MMX technology code that is not memory-bound, load merging is recommended only if the same memory address is used more than twice. Where load merging is not possible, usage of `OP reg, mem` instructions is recommended to minimize instruction count and code size.

For example,

```
movq MM0, [address A]
OP MM1, MM0
```

becomes

```
OP MM1, [address A]
```

In many cases, a `movq reg, reg` and `OP reg, mem` can be replaced by a `movq reg, mem` and `OP reg, reg`. This should be done where possible, since it saves one  $\mu\text{op}$  on Pentium II and Pentium III processors.

The code below, where OP is a commutative operation,

```
movq MM1, MM0      (1  $\mu$ op)  
OP MM1, [address A] (2  $\mu$ ops)
```

becomes:

```
movq MM1, [address A] (1  $\mu$ op)  
OP MM1, MM0      (1  $\mu$ op)
```

## Increasing Bandwidth of Memory Fills and Video Fills

It is beneficial to understand how memory is accessed and filled. A memory-to-memory fill (for example a memory-to-video fill) is defined as a 32-byte (cache line) load from memory which is immediately stored back to memory (such as a video frame buffer). The following are guidelines for obtaining higher bandwidth and shorter latencies for sequential memory fills (video fills). These recommendations are relevant for all Intel<sup>®</sup> architecture processors with MMX technology and refer to cases in which the loads and stores do not hit in the second level cache.

### Increasing Memory Bandwidth Using the MOVQ Instruction

Loading any value will cause an entire cache line to be loaded into the on-chip cache. But using `movq` to store the data back to memory instead of using 32-bit stores (for example, `movd`) will reduce by half the number of stores per memory fill cycle. As a result, the bandwidth of the memory fill cycle increases significantly. On some Pentium processor-based systems, 30% higher bandwidth was measured when 64-bit stores were used instead of 32-bit stores. Additionally, on Pentium II and Pentium III processors, this avoids a partial memory access when both the loads and stores are done with the MOVQ instruction.

Also, intermixing reads and writes is slower than doing a series of reads then writing out the data. For example when moving memory, it is faster to read several lines into the cache from memory then write them out again to the new memory location, instead of issuing one read and one write.

### Increasing Memory Bandwidth by Loading and Storing to and from the Same DRAM Page

DRAM is divided into pages, which are not the same as operating system (OS) pages. The size of a DRAM page is a function of the total size of the DRAM and the organization of the DRAM. Page sizes of several Kbytes are

common. Like OS pages, DRAM pages are constructed of sequential addresses. Sequential memory accesses to the same DRAM page have shorter latencies than sequential accesses to different DRAM pages. In many systems the latency for a page miss (that is, an access to a different page instead of the page previously accessed) can be twice as large as the latency of a memory page hit (access to the same page as the previous access). Therefore, if the loads and stores of the memory fill cycle are to the same DRAM page, a significant increase in the bandwidth of the memory fill cycles can be achieved.

### **Increasing the Memory Fill Bandwidth by Using Aligned STORES**

Unaligned stores will double the number of stores to memory. Intel strongly recommends that quadword stores be 8-byte aligned. Four aligned quadword stores are required to write a cache line to memory. If the quadword store is not 8-byte aligned, then two 32-bit writes result from each `MOVQ` store instruction. On some systems, a 20% lower bandwidth was measured when 64-bit misaligned stores were used instead of aligned stores.

### **Use 64-Bit Stores to Increase the Bandwidth to Video**

Although the PCI bus between the processor and the frame buffer is 32 bits wide, using `movq` to store to video is faster on most Pentium processor-based systems than using twice as many 32-bit stores to video. This occurs because the bandwidth to PCI write buffers (which are located between the processor and the PCI bus) is higher when quadword stores are used.

### **Increase the Bandwidth to Video Using Aligned Stores**

When a nonaligned store is encountered, there is a dramatic decrease in the bandwidth to video. Misalignment causes twice as many stores and the latency of stores on the PCI bus (to the frame buffer) is much longer. On the PCI bus, it is not possible to burst sequential misaligned stores. On Pentium processor-based systems, a decrease of 80% in the video fill bandwidth is typical when misaligned stores are used instead of aligned stores.

## Scheduling for the SIMD Integer Instructions

Scheduling instructions affects performance because the latency of instructions affects other instructions acting on them.

### Scheduling Rules

All MMX instructions can be pipelined, including the multiply instructions on Pentium II and Pentium III processors. All instructions take a single clock to execute except MMX technology multiply instructions which take three clocks.

Since multiply instructions take three clocks to execute, the result of a multiply instruction can be used only by other instructions issued three clocks later. For this reason, avoid scheduling a dependent instruction in the two-instruction sequences following the multiply.

The store of a register after writing the register must wait for two clock cycles after the update of the register. Scheduling the store of at least two clock cycles after the update avoids a pipeline stall.



# Optimizing Floating-point Applications

---

# 5

This chapter discusses general rules for optimizing single-instruction, multiple-data (SIMD) floating-point code and provides examples that illustrate the optimization techniques for SIMD floating-point applications.

## Rules and Suggestions

The rules and suggestions listed in this section help optimize floating-point code containing SIMD floating-point instructions. Generally, it is important to understand and balance port utilization to create efficient SIMD floating-point code. The basic rules and suggestions include the following:

- Balance the limitations of the architecture.
- Schedule instructions to resolve dependencies.
- Schedule usage of the triple/quadruple rule (port 0, port 1, port 2, 3, and 4).
- Group instructions that use the same registers as closely as possible. Take into consideration the resolution of true dependencies.
- Intermix SIMD floating-point operations that use port 0 and port 1.
- Do not issue consecutive instructions that use the same port.
- Exceptions: mask exceptions to achieve higher performance. Unmasked exceptions may cause a reduction in the retirement rate.
- Utilize the flush-to-zero mode for higher performance to avoid the penalty of dealing with denormals and underflows.
- Incorporate the prefetch instruction whenever possible (for details, refer to Chapter 6, “[Optimizing Cache Utilization for Pentium® III Processors](#)”).

- Try to emulate conditional moves by using masked compares and logicals instead of using conditional jumps.
- Use MMX™ technology instructions if the computations can be done in SIMD integer, for shuffling data, or for copying data that is not used later in SIMD floating-point computations.
- If the algorithm requires extended precision, then conversion to SIMD floating-point code is not advised because the Streaming SIMD Extensions for floating-point instructions are single-precision.
- Use the reciprocal instructions followed by iteration for increased accuracy. These instructions yield reduced accuracy but execute much faster. Note the following:
  - If reduced accuracy is acceptable, use them with no iteration.
  - If near full accuracy is needed, use a Newton-Raphson iteration.
  - If full accuracy is needed, then use divide and square root which provide more accuracy, but slow down performance.

## Planning Considerations

Whether adapting an existing application or creating a new one, using SIMD floating-point instructions to optimal advantage requires consideration of several issues. In general, when choosing candidates for optimization, look for code segments that are computationally intensive and floating-point intensive. Also consider efficient use of the cache architecture. Intel provides tools for evaluation and tuning.

The sections that follow answer the questions that should be raised before implementation:

- Which part of the code benefits from SIMD floating-point instructions?
- Is the current algorithm the most appropriate for SIMD floating-point instructions?
- Is the code floating-point intensive?
- Is the data arranged for efficient utilization of the SIMD floating-point registers?
- Is this application targeted for processors without SIMD floating-point instructions?

## Which Part of the Code Benefits from SIMD Floating-point Instructions?

Determine which code will benefit from SIMD floating-point instructions. Floating-point intensive applications that repeatedly execute similar operations where operations are repeated for multiple data sets, such as loops, might benefit from using SIMD floating-point instructions. Other factors that need to be considered include data organization if the kernel operation can use parallelism.

If the algorithm employed requires performance, range, and precision, then floating-point computation is the best choice. If performance is the primary reason for floating-point implementation, then the algorithm could increase its performance if converted to SIMD floating-point code.

## MMX Technology and Streaming SIMD Extensions Floating-point Code

When generating SIMD floating-point code, the rules for mixing MMX technology code and floating-point code do not apply. Since the SIMD floating-point registers are separate registers and are not mapped onto existing registers, SIMD floating-point code can be mixed with floating-point and MMX technology code. The SIMD floating-point instructions map to the same ports as the MMX technology and floating-point code. To avoid instruction stalls, consult Appendix C, “[Instruction to Decoder Specification](#),” when writing an application that mixes these various codes.

## Scalar Code Optimization

In terms of performance, the Streaming SIMD Extensions scalar code can do as well as x87 but has the following advantages:

- Using a flat register model rather than a stack model.
- Mixing with MMX technology code without penalty.
- Using scalar instructions on packed SIMD floating-point data when needed, since they bypass the upper fields of the packed data. This bypassing mechanism allows scalar code to have extra register storage by using the upper fields for temporary storage.

The following are some additional points to take into consideration when writing scalar code:

- The scalar code can run on two execution ports in addition to the load and store ports, an advantage over x87 code where it had only one floating-point execution port.
- The scalar code is decoded as 1 per cycle.
- To increase performance while avoiding this decoder limitation, use implicit loads with arithmetic instructions that increase the number of  $\mu$ ops decoded.

## EMMS Instruction Usage Guidelines

The EMMS instruction sets the values of all the tags in the floating-point unit (FPU) tag word to empty (all ones).

There are no requirements for using the `emms` instruction when mixing SIMD floating-point code with either MMX technology code or floating-point code. The `emms` instruction need only be used in the context of the existing rules for MMX technology intrinsics and floating-point code. It is only required when transitioning from MMX technology code to floating-point code. See Table 5-1 for details.

**Table 5-1** EMMS Instruction Usage Guidelines

Flow 1	Flow 2	EMMS Required
x87	MMX technology	No; ensure that stack is empty
x87	Streaming SIMD Extensions	No; ensure that stack is empty
x87	Streaming SIMD Extensions-SIMD floating-point	No
MMX technology	x87	Yes
MMX technology	Streaming SIMD Extensions-SIMD integer	No
MMX technology	Streaming SIMD Extensions-SIMD floating-point	No

continued

**Table 5-1 EMMS Instruction Usage Guidelines (continued)**

<b>Flow 1</b>	<b>Flow 2</b>	<b>EMMS Required</b>
Streaming SIMD Extensions-SIMD integer	x87	Yes
Streaming SIMD Extensions-SIMD integer	MMX technology	No
Streaming SIMD Extensions-SIMD integer	Streaming SIMD Extensions-SIMD floating-point	No
Streaming SIMD Extensions-SIMD floating-point	x87	No
Streaming SIMD Extensions-SIMD floating-point	MMX technology	No
Streaming SIMD Extensions-SIMD floating-point	Streaming SIMD Extensions-SIMD integer	No

### CPUID Usage for Detection of SIMD Floating-point Support

Applications must be able to determine if Streaming SIMD Extensions are available. Please refer the section [“Checking for Processor Support of Streaming SIMD Extensions and MMX™ Technology” in Chapter 3](#) for the techniques to determine whether the processor and operating system support Streaming SIMD Extensions.

### Data Alignment

The data must be 16-byte-aligned for packed floating-point operations (that is, no alignment constraint for scalar floating-point). If the data is not 16-byte-aligned, a general protection exception will be generated. If you know that the data is not aligned, use the `movups` (`mov unaligned`) instruction to avoid the protection error exception. The `movups` instruction is the only one that can access unaligned data.

Accessing data that is properly aligned can save six to nine cycles on the Pentium® III processor. If the data is properly aligned on a 16-byte boundary, frequent access can provide a significant performance improvement.

## Data Arrangement

Since the Streaming SIMD Extensions incorporate a SIMD architecture, arranging the data to fully use the SIMD registers produces optimum performance. This implies contiguous data for processing, which leads to fewer cache misses and potentially quadruples the speed. These performance gains occur because the four-element SIMD registers can be loaded with 128-bit load instructions (`movaps` – move aligned packed single precision).

Refer to the [“Stack and Data Alignment” in Chapter 3](#) for data arrangement recommendations. Duplicating and padding techniques overcome the misalignment problem that can occur in some data structures and arrangements. This increases the data space but avoids the expensive penalty for misaligned data access.

The traditional data arrangement does not lend itself to SIMD parallel techniques in some applications. Traditional 3D data structures, for example, do not lead to full utilization of the SIMD registers. This data layout has traditionally been an array of structures (AoS). To fully utilize the SIMD registers, a new data layout has been proposed—a structure of arrays (SoA). The SoA structure allows the application to fully utilize the SIMD registers. With full utilization comes more optimized performance.

## Vertical versus Horizontal Computation

Traditional 3D data structures do not lend themselves to vertical computation. The data can still be operated on and computation can proceed, but without optimally utilizing the SIMD registers. To optimally utilize the SIMD registers the data can be organized in the SoA format as mentioned above.

Consider 3D geometry data organization. One way to apply SIMD technology to a typical 3D geometry is to use horizontal execution. This means to parallelize the computation on the **x**, **y**, **z**, and **w** components of a single vertex (that is, of a single vector simultaneously referred to as an **xyz** data representation, see the diagram below).



Vertical computation, SoA, is recommended over horizontal, for several reasons:

- When computing on a single vector (**xyz**), it is common to use only a subset of the vector components; for example, in 3D graphics the **w** component is sometimes ignored. This means that for single-vector operations, 1 of 4 computation slots is not being utilized. This results in a 25% reduction of peak efficiency, and only 75% peak performance can be attained.
- It may become difficult to hide long latency operations. For instance, another common function in 3D graphics is normalization, which requires the computation of a reciprocal square root (that is,  $1/\sqrt{\phantom{x}}$ ); both the division and square root are long latency operations. With vertical computation (SoA), each of the 4 computation slots in a SIMD operation is producing a unique result, so the net latency per slot is  $L/4$  where  $L$  is the overall latency of the operation. However, for horizontal computation, the 4 computation slots each produce the same result, hence to produce 4 separate results requires a net latency per slot of  $L$ .

How can the data be organized to utilize all 4 computation slots? The vertex data can be reorganized to allow computation on each component of 4 separate vertices, that is, processing multiple vectors simultaneously. This will also be referred to as an SoA form of representing vertices data shown in Table 5-2.

**Table 5-2 SoA Form of Representing Vertices Data**

Vx array	X1	X2	X3	X4	.....	Xn
Vy array	Y1	Y2	Y3	Y4	.....	Yn
Vz array	Z1	Z2	Z3	Y4	.....	Zn
Vw array	W1	W2	W3	W4	.....	Wn

Organizing data in this manner yields a unique result for each computational slot for each arithmetic operation. Vertical computation takes advantage of the inherent parallelism in 3D geometry processing of vertices. It assigns the computation of four vertices to the four compute slots of the Pentium III processor, thereby eliminating the disadvantages of the horizontal approach described earlier. The dot product operation implements the SoA representation of vertices data. A schematic representation of dot product operation is shown in Figure 5-1.

**Figure 5-1 Dot Product Operation**

	X1	X2	X3	X4
x	Fx	Fx	Fx	Fx
+	Y1	Y2	Y3	Y4
x	Fy	Fy	Fy	Fy
+	Z1	Z2	Z3	Z4
x	Fz	Fz	Fz	Fz
+	W1	W2	W3	W4
x	Fw	Fw	Fw	Fw
=	R1	R2	R3	R4

Example 5-1 shows how 1 result would be computed for 7 instructions if the data were organized as AoS. Hence 4 results would require 28 instructions.



---

**Example 5-1 Pseudocode for Horizontal (xyz, AoS) Computation**

---

```
mulps    ; x*x', y*y', z*z'  
movaps   ; reg->reg move, since next steps overwrite  
shufps   ; get b,a,d,c from a,b,c,d  
addps    ; get a+b,a+b,c+d,c+d  
movaps   ; reg->reg move  
shufps   ; get c+d,c+d,a+b,a+b from prior addps  
addps    ; get a+b+c+d,a+b+c+d,a+b+c+d,a+b+c+d
```

---

Now consider the case when the data is organized as SoA. Example 5-2 demonstrates how 4 results are computed for 5 instructions.

---

**Example 5-2 Pseudocode for Vertical (xxxx, yyyy, zzzz, SoA) Computation**

---

```
mulps    ; x*x' for all 4 x-components of 4 vertices  
mulps    ; y*y' for all 4 y-components of 4 vertices  
mulps    ; z*z' for all 4 z-components of 4 vertices  
addps    ; x*x' + y*y'  
addps    ; x*x'+y*y'+z*z'
```

---

For the most efficient use of the four component-wide registers, reorganizing the data into the SoA format yields increased throughput and hence much better performance for the instructions used.

As can be seen from this simple example, vertical computation yielded 100% use of the available SIMD registers and produced 4 results. If the data structures are restricted to a format that is not “friendly to vertical computation,” it can be rearranged “on the fly” to achieve full utilization of the SIMD registers. This operation referred to as “swizzling” and the “deswizzling” operation are discussed in the following sections.

## Data Swizzling

In many algorithms, swizzling data from one format to another is required. An example of this is AoS format, where the vertices come as *xyz* adjacent coordinates. Rearranging them into SoA format, *xxxx*, *yyyy*, *zzzz*, allows more efficient SIMD computations. The following instructions can be used for efficient data shuffling and swizzling:

- `movlps`, `movhps` load/store and move data on half sections of the registers
- `shuffps`, `unpackhps`, and `unpacklps` unpack data

To gather data from 4 different memory locations on the fly, follow steps:

1. identify the first half of the 128-bit memory location.
2. group the different halves together using the `movlps` and `movhps` to form an *xyxy* layout in two registers
3. from the 4 attached halves, get the *xxxx* by using one shuffle, the *yyyy* by using another shuffle.

The *zzzz* is derived the same way but only requires one shuffle.

Example 5-3 illustrates the swizzle function.

---

### Example 5-3 Swizzling Data

---

```
typedef struct _VERTEX_AOS {
    float x, y, z, color;
} Vertex_aos; // AoS structure declaration
typedef struct _VERTEX_SOA {
    float x[4], float y[4], float z[4];
    float color[4];
} Vertex_soa; // SoA structure declaration
void swizzle_asm (Vertex_aos *in, Vertex_soa *out)
{
    // in mem: x1y1z1w1-x2y2z2w2-x3y3z3w3-x4y4z4w4-
    // SWIZZLE XYZW --> XXXX
    asm {
        mov ecx, in // get structure addresses
        mov edx, out
```

---

continued

**Example 5-3 Swizzling Data (continued)**

```

movlps xmm7, [ecx]      // xmm7 = -- -- y1 x1
movhps xmm7, [ecx+16]   // xmm7 = y2 x2 y1 x1
movlps xmm0, [ecx+32]   // xmm0 = -- -- y3 x3
movhps xmm0, [ecx+48]   // xmm0 = y4 x4 y3 x3
movaps xmm6, xmm7       // xmm6 = y1 x1 y1 x1
shufps xmm7, xmm0, 0x88// xmm7 = x1 x2 x3 x4 => X
shufps xmm6, xmm0, 0xDD// xmm6 = y1 y2 y3 y4 => Y
movlps xmm2, [ecx+8]    // xmm2 = -- -- w1 z1
movhps xmm2, [ecx+24]   // xmm2 = w2 z2 u1 z1
movlps xmm1, [ecx+40]   // xmm1 = -- -- s3 z3
movhps xmm1, [ecx+56]   // xmm1 = w4 z4 w3 z3
movaps xmm0, xmm2       // xmm0 = w1 z1 w1 z1
shufps xmm2, xmm1, 0x88// xmm2 = z1 z2 z3 z4 => Z
shufps xmm0, xmm1, 0xDD// xmm6 = w1 w2 w3 w4 => W
movaps [edx], xmm7      // store X
movaps [edx+16], xmm6   // store Y
movaps [edx+32], xmm2   // store Z
movaps [edx+48], xmm0   // store W
// SWIZZLE XYZ -> XXX
}
}

```

Example 5-4 shows the same data swizzling algorithm encoded using the Intel® C/C++ Compiler’s intrinsics for Streaming SIMD Extensions.

**Example 5-4 Swizzling Data Using Intrinsics**

---

```
//Intrinsics version of data swizzle
void swizzle_intrin (Vertex_aos *in, Vertex_soa *out,
int stride)
{
    __m128 x, y, z, w;
    __m128 tmp;

    x = _mm_loadl_pi(x,(__m64 *(in));
    x = _mm_loadh_pi(x,(__m64 *(stride + (char *(in)));
    y = _mm_loadl_pi(y,(__m64 *(2*stride+char *(in)));
    y = _mm_loadh_pi(y,(__m64 *(3*stride+(char *(in)));
    tmp = _mm_shuffle_ps( x, y, _MM_SHUFFLE( 2, 0, 2, 0));
    y = _mm_shuffle_ps( x, y, _MM_SHUFFLE( 3, 1, 3, 1));
    x = tmp;

    z = _mm_loadl_pi(z,(__m64 *(8 + (char *(in)));
    z = _mm_loadh_pi(z,(__m64 *(stride+8+(char *(in)));
    w = _mm_loadl_pi(w,(__m64 *(2*stride+8+(char*(in)));
    w = _mm_loadh_pi( w,(__m64
    *(3*stride+8+(char*(in)));
    w = _mm_shuffle_ps( z, w, _MM_SHUFFLE( 3, 1, 3, 1));
    z = tmp;
    tmp = _mm_shuffle_ps( z, w, _MM_SHUFFLE( 2, 0, 2, 0));
    _mm_store_ps(&out->x[0], x);
    _mm_store_ps(&out->y[0], y);
    _mm_store_ps(&out->z[0], z);
    _mm_store_ps(&out->w[0], w);
}
```

---



---

**CAUTION.** *Avoid creating a dependency chain from previous computations because the `movhps/movlps` instructions bypass one part of the register. The same issue can occur with the use of an exclusive-OR function within an inner loop in order to clear a register:*

```
XORPS %xmm0, %xmm0;    All 0's written to xmm0
```

---

Although the generated result of all zeros does not depend on the specific data contained in the source operand (that is, `XOR` of a register with itself always produces all zeros), the instruction cannot execute until the instruction that generates `xmm0` has completed. In the worst case, this creates a dependency chain that links successive iterations of the loop, even if those iterations are otherwise independent; the resulting performance impact can be significant depending on how much other independent intra-loop computation is being performed.

The same situation can occur for the above `movhps/movlps/shufps` sequence. Since each `movhps/movlps` instruction bypasses part of the destination register, the instruction cannot execute until the prior instruction to generate this register has completed. As with the `xorps` example, in the worst case this dependency can prevent successive loop iterations from executing in parallel.

A solution is to include a 128-bit load (that is, from a dummy local variable, such as `tmp` in Example 5-4) to each register to be used with a `movhps/movlps` instruction; this action effectively breaks the dependency by performing an independent load from a memory or cached location.

### Data Deswizzling

In the deswizzle operation, we want to arrange the SoA format back into AoS format so the `xxxx`, `yyyy`, `zzzz` are rearranged and stored in memory as `xyx`. To do this we can use the `unpcklps/unpckhps` instructions to regenerate the `xyxy` layout and then store each half (`xy`) into its corresponding memory location using `movlps/movhps` followed by another `movlps/movhps` to store the `z` component.

Example 5-5 illustrates the deswizzle function:

### Example 5-5 Deswizzling Data

---

```
void deswizzle_asm(Vertex_soa *in, Vertex_aos *out)
{
    __asm {
        mov     ecx, in           // load structure addresses
        mov     edx, out
        movaps  xmm7, [ecx]      // load x1 x2 x3 x4 => xmm7
        movaps  xmm6, [ecx+16]   // load y1 y2 y3 y4 => xmm6
        movaps  xmm5, [ecx+32]   // load z1 z2 z3 z4 => xmm5
        movaps  xmm4, [ecx+48]   // load w1 w2 w3 w4 => xmm4

        // START THE DESWIZZLING HERE
        movaps  xmm0, xmm7       // xmm0= x1 x2 x3 x4
        unpkhps xmm7, xmm6       // xmm7= x1 y1 x2 y2
        movlps  [edx], xmm7      // v1 = x1 y1 -- --
        movhps  [edx+16], xmm7   // v2 = x2 y2 -- --
        unpkhps xmm0, xmm6       // xmm0= x3 y3 x4 y4
        movlps  [edx+32], xmm0   // v3 = x3 y3 -- --
        movhps  [edx+48], xmm0   // v4 = x4 y4 -- --
        movaps  xmm0, xmm5       // xmm0= z1 z2 z3 z4
        unpkhps xmm5, xmm4       // xmm5= z1 w1 z2 w2
        unpkhps xmm0, xmm4       // xmm0= z3 w3 z4 w4
        movlps  [edx+8], xmm5    // v1 = x1 y1 z1 w1
        movhps  [edx+24], xmm5   // v2 = x2 y2 z2 w2
        movlps  [edx+40], xmm0   // v3 = x3 y3 z3 w3
        movhps  [edx+56], xmm0   // v4 = x4 y4 z4 w4
        // DESWIZZLING ENDS HERE
    }
}
```

---

You may have to swizzle data in the registers, but not in memory. This occurs when two different functions want to process the data in different layout. In lighting, for example, data comes as `rrrr gggg bbbb aaaa`, and you must deswizzle them into `rgba` before converting into integers. In this case you use the `movlhps/movhlps` instructions to do the first part of the deswizzle, followed by `shuffle` instructions, Example 5-6 and Example 5-7.

### Example 5-6 Deswizzling Data Using the `movlhps` and `shuffle` Instructions

```
void deswizzle_rgb(Vertex_soa *in, Vertex_aos *out)
{
//-----deswizzle rgb-----
// xmm1 = rrrr, xmm2 = gggg, xmm3 = bbbb, xmm4 = aaaa
(assumed)
    __asm {
        mov    ecx, in           // load structure addresses
        mov    edx, out
        movaps xmm1, [ecx]      // load r1 r2 r3 r4 => xmm1
        movaps xmm2, [ecx+16]   // load g1 g2 g3 g4 => xmm2
        movaps xmm3, [ecx+32]   // load b1 b2 b3 b4 => xmm3
        movaps xmm4, [ecx+48]   // load a1 a2 a3 a4 => xmm4
// Start deswizzling here
        movaps xmm7, xmm4      // xmm7= a1 a2 a3 a4
        movhlps xmm7, xmm3     // xmm7= b3 b4 a3 a4
        movaps xmm6, xmm2      // xmm6= g1 g2 g3 g4
        movlhps xmm3, xmm4     // xmm3= b1 b2 a1 a2
        movhlps xmm2, xmm1     // xmm2= r3 r4 g3 g4
        movlhps xmm1, xmm6     // xmm1= r1 r2 g1 g2
        movaps xmm6, xmm2      // xmm6= r3 r4 g3 g4
        movaps xmm5, xmm1      // xmm5= r1 r2 g1 g2
        shufps xmm2, xmm7, 0xDD // xmm2= r4 g4 b4 a4
        shufps xmm1, xmm3, 0x88 // xmm4= r1 g1 b1 a1
        shufps xmm5, xmm3, 0x88 // xmm5= r2 g2 b2 a2
        shufps xmm6, xmm7, 0xDD // xmm6= r3 g3 b3 a3
    }
```

continued

---

**Example 5-6 Deswizzling Data Using the movlhps and shuffle Instructions**  
 (continued)
 

---

```

movaps [edx], xmm4      // v1 = r1 g1 b1 a1
movaps [edx+16], xmm5   // v2 = r2 g2 b2 a2
        movaps [edx+32], xmm6   // v3 = r3 g3 b3 a3
        movaps [edx+48], xmm2   // v4 = r4 g4 b4 a4
// DESWIZZLING ENDS HERE
    }
}

```

---

**Example 5-7 Deswizzling Data Using Intrinsics with the movlhps and shuffle Instructions**

---

```

void mmx_deswizzle(IVertex_soa *in, IVertex_aos *out)
{
    __asm {
        mov    ebx, in
        mov    edx, out
        movq   mm0, [ebx]      // mm0= u1 u2
        movq   mm1, [ebx+16]  // mm1= v1 v2
        movq   mm2, mm0       // mm2= u1 u2
        punpckhdq mm0, mm1    // mm0= u1 v1
        punpckldq mm2, mm1    // mm0= u2 v2
        movq   [edx], mm2     // store u1 v1
        movq   [edx+8], mm0    // store u2 v2
        movq   mm4, [ebx+8]   // mm0= u3 u4
        movq   mm5, [ebx+24]  // mm1= v3 v4
        movq   mm6, mm4       // mm2= u3 u4
        punpckhdq mm4, mm5    // mm0= u3 v3
        punpckldq mm6, mm5    // mm0= u4 v4
        movq   [edx+16], mm6   // store u3v3
        movq   [edx+24], mm4   // store u4v4
    }
}

```

---



## Using MMX Technology Code for Copy or Shuffling Functions

If there are some parts in the code that are mainly copying, shuffling, or doing logical manipulations that do not require use of Streaming SIMD Extensions code, consider performing these actions with MMX technology code. For example, if texture data is stored in memory as SoA (**uuuu**, **vvvv**) and they need only to be deswizzled into AoS layout (**uv**) for the graphic cards to process, you can use either the Streaming SIMD Extensions or MMX technology code, but MMX technology code has these two advantages:

- The MMX instructions can decode on 3 decoders while Streaming SIMD Extensions code uses only one decoder.
- The MMX instructions allow you to avoid consuming Streaming SIMD Extension registers for just rearranging data from memory back to memory.

Example 5-8 illustrates how to use MMX technology code for copying or shuffling.

**Example 5-8 Using MMX Technology Code for Copying or Shuffling**

```

asm("movq TRICOUNT*12(%ebx, %esi, 4),%mm0"); // mm0= u1
u2
asm("movq TRICOUNT*16(%ebx, %esi, 4),%mm1"); // mm1= v1
v2
asm("movq %mm0,%mm2"); // mm2= u1 u2
asm("punpckhdq %mm1,%mm0");// mm0= u1 v1
asm("punpckldq %mm1,%mm2");// mm0= u2 v2
asm("movq %mm0, 24+0*32(%edx)");// store u1v1
asm("movq %mm2, 24+1*32(%edx)");// store u2v2
asm("movq TRICOUNT*12(%ebx, %esi, 4), %mm4"); //
mm0= u3 u4

should be address+8
asm("movq TRICOUNT*16(%ebx, %esi, 4), %mm5"); //
mm1= v3 v4

should be address+8
asm("movq %mm4,%mm6");// mm2= u3 u4
asm("punpckhdq %mm5,%mm4");// mm0= u3 v3
asm("punpckldq %mm5,%mm6");// mm0= u4 v4
asm("movq %mm4, 24+0*32(%edx)");// store u3v3
asm("movq %mm6, 24+1*32(%edx)");// store u4v4

```

**Horizontal ADD**

Although vertical computations use the SIMD performance better than horizontal computations do, in some cases, the code must use a horizontal operation. The `movlhps/movhlps` and `shuffle` can be used to sum data horizontally. For example, starting with four 128-bit registers, to sum up each register horizontally while having the final results in one register, use the `movlhps/movhlps` instructions to align the upper and lower parts of each register. This allows you to use a vertical add. With the resulting partial horizontal summation, full summation follows easily. Figure 5-2 schematically presents horizontal add using `movhlps/movlhps`, while Example 5-9 and Example 5-10 provide the code for this operation.

**Figure 5-2 Horizontal Add Using movhlps/movhlps**

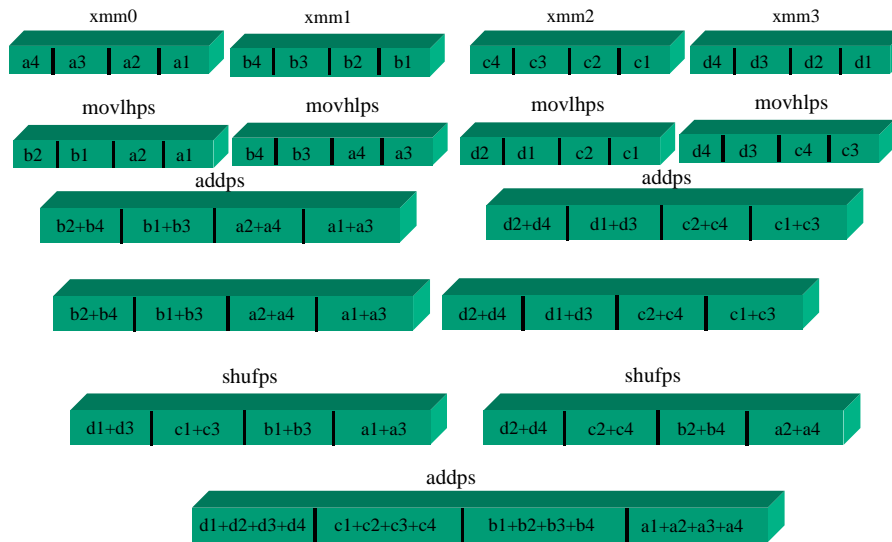

**Example 5-9 Horizontal Add Using movhlps/movlhps**

---

```
void horiz_add(Vertex_soa *in, float *out) {
    __asm {
        mov     ecx, in           // load structure addresses
        mov     edx, out
        movaps  xmm0, [ecx]      // load A1 A2 A3 A4 => xmm0
        movaps  xmm1, [ecx+16]   // load B1 B2 B3 B4 => xmm1
        movaps  xmm2, [ecx+32]   // load C1 C2 C3 C4 => xmm2
        movaps  xmm3, [ecx+48]   // load D1 D2 D3 D4 => xmm3
    // START HORIZONTAL ADD
        movaps  xmm5, xmm0 // xmm5= A1,A2,A3,A4
        movlhps xmm5, xmm1 // xmm5= A1,A2,B1,B2
        movhlps xmm1, xmm0 // xmm1= A3,A4,B3,B4
        addps   xmm5, xmm1 // xmm5= A1+A3,A2+A4,B1+B3,B2+B4
        movaps  xmm4, xmm2
        movlhps xmm2, xmm3 // xmm2= C1,C2,D1,D2
        movhlps xmm3, xmm4 // xmm3= C3,C4,D3,D4
        addps   xmm3, xmm2 // xmm3= C1+C3,C2+C4,D1+D3,D2+D4
        movaps  xmm6, xmm5 // xmm6= A1+A3,A2+A4,B1+B3,B2+B4
        shufps  xmm6, xmm3, 0x31
                                //xmm6=A1+A3,B1+B3,C1+C3,D1+D3
        shufps  xmm5, xmm3, 0xAA
                                // xmm5= A2+A4,B2+B4,C2+C4,D2+D4
        addps   xmm6, xmm5 // xmm6= D,C,B,A
    // END HORIZONTAL ADD
        movaps  [edx], xmm6
    }
}
```

---

**Example 5-10 Horizontal Add Using Intrinsics with movhlps/movlhps**

---

```

void horiz_add_intrin(Vertex_soa *in, float *out)
{
    __m128 v1, v2, v3, v4;
    __m128 tmm0, tmm1, tmm2, tmm3, tmm4, tmm5, tmm6;
                                // Temporary variables
    tmm0 = _mm_load_ps(in->x); //tmm0 = A1 A2 A3 A4
    tmm1 = _mm_load_ps(in->y); //tmm1 = B1 B2 B3 B4
    tmm2 = _mm_load_ps(in->z); //tmm2 = C1 C2 C3 C4
    tmm3 = _mm_load_ps(in->w); //tmm3 = D1 D2 D3 D4

    tmm5 = tmm0;                //tmm0 = A1 A2 A3 A4
    tmm5 = _mm_movehl_ps(tmm5, tmm1); //tmm5 = A1 A2 B1 B2
    tmm1 = _mm_movelh_ps(tmm1, tmm0); //tmm1 = A3 A4 B3 B4
    tmm5 = _mm_add_ps(tmm5, tmm1);
                                //tmm5 = A1+A3 A2+A4 B1+B3 B2+B4
    tmm4 = tmm2;
    tmm2 = _mm_movehl_ps(tmm2, tmm3); //tmm2 = C1 C2 D1 D2
    tmm3 = _mm_movelh_ps(tmm3, tmm4); //tmm3 = C3 C4 D3 D4
    tmm3 = _mm_add_ps(tmm3, tmm2);
                                //tmm3 = C1+C3 C2+C4 D1+D3 D2+D4
    tmm6 = tmm5;                //tmm6 = A1+A3 A2+A4 B1+B3 B2+B4
    tmm6 = _mm_shuffle_ps(tmm6, tmm3, 0x88);
                                //tmm6 = A1+A3 B1+B3 C1+C3 D1+D3
    tmm5 = _mm_shuffle_ps(tmm5, tmm3, 0xDD);
                                //tmm5 = A2+A4 B2+B4 C2+C4 D2+D4
    tmm6 = _mm_add_ps(tmm6, tmm5);
                                //tmm6 = A1+A2+A3+A4 B1+B2+B3+B4
                                //C1+C2+C3+C4 D1+D2+D3+D4
    _mm_store_ps(out, tmm6);
}
    
```

---

## Scheduling

Instructions using the same registers should be scheduled close to each other. There are two read ports for registers. You can obtain the most efficient code if you schedule those instructions that read from the same registers together without severely affecting the resolution of true dependencies. As an exercise, first examine the non-optimal code in the first block of Example 5-11, then examine the second block of optimized code. The reads from the registers can only read two physical registers per clock.

---

### Example 5-11 Scheduling Instructions that Use the Same Register

---

```
int toy(unsigned char *sptr1,
        unsigned char *sptr2)
{
    __asm {
        push    ecx
        mov     ebx, [ebp+8] // sptr1
        mov     eax, [ebp+12] // sptr2
        movq    mm1, [eax]
        movq    mm3, [ebx]
        pxor    mm0, mm0 // initialize mm0 to 0
        pxor    mm5, mm5 // initialize mm5 to 0
        pxor    mm6, mm6 // initialize mm6 to 0
        pxor    mm7, mm7 // initialize mm7 to 0
        mov     ecx, 256 // initialize loop counter
top_of_loop:
        movq    mm2, [ebx+ecx+8]
        movq    mm4, [eax+ecx+8]
        paddw   mm6, mm5
        pmullw  mm1, mm3
        movq    mm3, [ebx+ecx+16]
        movq    mm5, [eax+ecx+16]
        paddw   mm7, mm6
```

---

continued

**Example 5-11 Scheduling Instructions that Use the Same Register** (continued)

```

pmullw mm2, mm4
    movq mm4, [ebx+ecx+24]
    movq mm6, [eax+ecx+24]
    paddw mm0, mm7
pmullw mm3, mm5
    movq mm5, [ebx+ecx+32]
    movq mm7, [eax+ecx+32]
    paddw mm1, mm0
pmullw mm4, mm6
    movq mm6, [ebx+ecx+40]
    movq mm0, [eax+ecx+40]
    paddw mm2, mm1
pmullw mm5, mm7
    movq mm7, [ebx+ecx+48]
    movq mm1, [eax+ecx+48]
    paddw mm3, mm2
pmullw mm6, mm0
    movq mm0, [ebx+ecx+56]
    movq mm2, [eax+ecx+56]
    paddw mm4, mm3
pmullw mm7, mm1
    movq mm1, [ebx+ecx+64]
    movq mm3, [eax+ecx+64]
    paddw mm5, mm4
pmullw mm0, mm2
    movq mm2, [ebx+ecx+72]
    movq mm4, [eax+ecx+72]
    paddw mm6, mm5

```

continued

**Example 5-11 Scheduling Instructions that Use the Same Register** (continued)

---

```
    pmullw  mm1, mm3
        sub   ecx, 64
        jg   top_of_loop
        // no horizontal reduction needed at the end
        movd  [eax], mm6
        pop  ecx
    }
}
```

---

Try to group instructions using the same registers as closely as possible. Also try to schedule instructions so that data is still in the reservation station when new instructions that use the same registers are issued to them. The source remains in the reservation station until the instruction is dispatched. Now you can bypass directly to the functional unit because dependent instructions have spaced far enough away to resolve dependencies.

**Scheduling with the Triple-Quadruple Rule**

Schedule instructions using the triple/quadruple rule, **add/mult/load**, and combine triplets from independent chains of instructions. Split register-memory instructions into a load followed by the actual computation. As an example, split `addps xmm0, [edi]` into `movaps xmm1, [edi]` and `addps xmm0, xmm1`. Increase the distance between the load and the actual computation and try to insert independent instructions between them. This technique works well unless you have register pressure or you are limited by decoder throughput, see Example 5-12.



### Example 5-12 Scheduling with the Triple/Quadruple Rule

```

int toy(sptrl, sptr2)
__m64 *sptrl, *sptr2;
{
    __m64    src1;    /* source 1 */
    __m64    src2;    /* source 2 */
    __m64    m;      /* mul */
    __m64    result; /* result */
    int      i;
    result=0;
    for(i=0; i<n; i++, sptrl += stride, sptr2 += stride) {
        src1 = *sptrl;
        src2 = *sptr2;
        m = _m_pmulw(src1, src2);
        result = _m_paddw(result, m);
        src1 = *(sptrl+1);
        src2 = *(sptr2+1);
        m = _m_pmulw(src1, src2);
        result = _m_paddw(result, m);
    }
    return( _m_to_int(result) );
}
    
```

### Modulo Scheduling (or Software Pipelining)

This particular approach to scheduling known as modulo scheduling achieves high throughput by overlapping the execution of several iterations and thus helps to reduce register pressure. The technique uses the same schedule for each iteration of a loop and initiates successive iterations at a constant rate, that is, one *initiation interval* (II) clocks apart. To effectively code your algorithm using this technique, you need to know the following:

- instruction latencies
- the number of available resources
- availability of adequate registers

Consider a simple loop that fetches `src1` and `src2` (like in Example 5-12), multiplies them, and accumulates the multiplication result. The assumptions are:

<u>Instruction</u>	<u>Latency</u>	<u>Throughput</u>
Load	3 clocks	1 clock
Multiply	4 clocks	2 clocks
Add	1 clock	1 clock

Now examine this simple kernel's dependency graph in Figure 5-3, and the schedule, in Table 5-3.

**Figure 5-3** Modulo Scheduling Dependency Graph

---

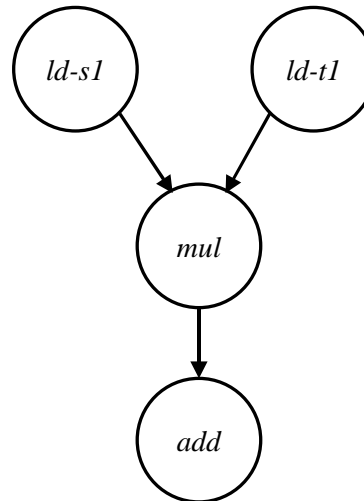

**Table 5-3 EMMS Modulo Scheduling**

clk	load	mul	add
0	lds1		
1	ldt1		
2	ldt2		
3	lds2		
4		mul1	
5			
6		mul2	
7			
8			add1
9			
10			add2

Now starting from the schedule for one iteration (above), overlap the schedule for several iterations in a spreadsheet or in a table as shown in Table 5-4

**Table 5-4 EMMS Schedule – Overlapping Iterations**

clk	load	mul	add
0	lds1		prolog
1	ldt1		
2	lds2		
3	ldt2		
4	lds3	mul1	
5	ldt3		
6	lds4	mul2	
7	ldt4		

continued

**Table 5-4 EMMS Schedule – Overlapping Iterations (continued)**

clk	load	mul	add	
8	lds5	mul3	add1	steady state
9	ldt5			
10	lds6	mul4	add2	
11	ldt6			
12		mul5	add3	epilog
13				
14		mul6	add4	
15				
16			add5	
17				
18			add6	

Careful examination of this schedule shows that steady state execution for this kernel occurs after two iterations. As with any pipelined loop, there is a prolog and epilog. This is also referred to as loop setup and loop shutdown, or filling the pipes and flushing the pipes.

Now assume the initiation interval **MRT** ( $II = 4$ ) and examine the schedule in Table 5-5.

**Table 5-5 Modulo Scheduling with Interval MRT (II=4)**

clk	MRT(II=4)		
	load	mul	add
0	ld	mul	add
1	ld		
2	ld	mul	add
3	ld		

How do we schedule this particular scenario and allocate registers? The Pentium II and Pentium III processors can execute instructions out of order. Example 5-13 shows an improved version of the code, with proper scheduling resulting in 20% performance increase.

### Example 5-13 Proper Scheduling for Performance Increase

```

int toy(sptrl, sptr2)
unsigned char *sptrl, *sptr2;
{
asm("pushl    %ecx");
asm("movl    12(%ebp), %ebx"); // sptrl
asm("movl    8(%ebp), %eax"); // sptr2
asm("movq    (%eax,%ecx), %mm1");
asm("movq    (%ebx,%ecx), %mm3");
asm("pxor    %mm0,    %mm0"); // initialize mm0 to 0
asm("pxor    %mm5,    %mm5"); // initialize mm5 to 0
asm("pxor    %mm6,    %mm6"); // initialize mm6 to 0
asm("pxor    %mm7,    %mm7"); // initialize mm7 to 0
asm("movl    16*stride, %ecx"); // initialize loop
counter
asm("top_of_loop:");
asm("movq    8(%ebx,%ecx), %mm2");
asm("movq    8(%eax,%ecx), %mm4");
asm("paddw   %mm5,    %mm6");
asm("pmulw   %mm3,    %mm1");
asm("movq    stride(%ebx,%ecx), %mm3");
asm("movq    stride(%eax,%ecx), %mm5");
asm("paddw   %mm6,    %mm7");
asm("pmulw   %mm4,    %mm2");
asm("movq    stride+8(%ebx,%ecx), %mm4");
asm("movq    stride+8(%eax,%ecx), %mm6");
asm("paddw   %mm7,    %mm0");
asm("pmulw   %mm5,    %mm3");
asm("movq    2*stride(%ebx,%ecx), %mm5");
asm("movq    2*stride(%eax,%ecx), %mm7");
asm("paddw   %mm0,    %mm1");
asm("pmulw   %mm6,    %mm4");
asm("movq    2*stride+8(%ebx,%ecx), %mm6");
asm("movq    2*stride+8(%eax,%ecx), %mm0");

```

continued

**Example 5-13 Proper Scheduling for Performance Increase** (continued)

---

```
asm( "paddw    %mm1,    %mm2" );
asm( "pmulw    %mm7,    %mm5" );
asm( "movq     3*stride(%ebx,%ecx), %mm7" );
asm( "movq     3*stride(%eax,%ecx), %mm1" );
asm( "paddw    %mm2,    %mm3" );
asm( "pmulw    %mm0,    %mm6" );
asm( "movq     3*stride+8(%ebx,%ecx), %mm0" );
asm( "movq     3*stride+8(%eax,%ecx), %mm2" );
asm( "paddw    %mm3,    %mm4" );
asm( "pmulw    %mm1,    %mm7" );
asm( "movq     4*stride(%ebx,%ecx), %mm1" );
asm( "movq     4*stride(%eax,%ecx), %mm3" );
asm( "paddw    %mm4,    %mm5" );
asm( "pmulw    %mm2,    %mm0" );
asm( "movq     4*stride+8(%ebx,%ecx), %mm2" );
asm( "movq     4*stride+8(%eax,%ecx), %mm4" );
asm( "paddw    %mm5,    %mm6" );
asm( "pmulw    %mm3,    %mm1" );
asm( "subl     4*stride, %ecx" );
asm( "jg      top_of_loop" );
// no horizontal reduction needed at the end
asm( "movd     %mm6,    %eax" );
asm( "popl     %ecx" );
}
```

---

Example 5-13 also shows that to achieve better performance, it is necessary to expose the instruction level parallelism to the processor. In exposing the parallelism keep in mind these considerations:

- Use the available issue ports.
- Expose independent instructions such that the processor can schedule them efficiently.

## Scheduling to Avoid Register Allocation Stalls

After the  $\mu$ ops are decoded, they are allocated into a buffer with the corresponding data sources to be dispatched to the execution units. If the sources are already in the dispatch buffer from previous producers of those sources, then no stalls will happen. However, if producers and consumers are separated further than needed to resolve dependency, then the producer results will no longer be in the dispatch buffer when they are needed for the consuming  $\mu$ ops. The general rule of thumb is to try to balance the distance between the producers and consumers so that dependency will have some time to resolve, but not so much time that results are not lost from the buffer.

## Forwarding from Stores to Loads

Be careful when performing loads from a memory location that was previously and recently stored, since certain types of store forwarding may incur a longer latency than others. In particular, storing a result that has a smaller data size than that of the following load, may result in a longer latency than if a 64-bit load is used. An example of this is two 64-bit MMX technology stores (`movq`) followed by a 128-bit Streaming SIMD Extensions load (`movaps`).

## Conditional Moves and Port Balancing

Conditional moves emulation and port balancing can greatly contribute to your application's performance gains using the techniques explained in the following sections.

### Conditional Moves

If possible, emulate conditional moves by using masked compares and logical instructions instead of conditional branches. Mispredicted branches impede the Pentium III processor's performance. In the Pentium II and Pentium III processors prior to processors with Streaming SIMD Extensions, execution Port 1 is solely dedicated to 1-cycle latency  $\mu$ ops (for example, `cjmp`). In the Pentium III processor, additional execution units were added to Port 1, to execute new 3-cycle latency  $\mu$ ops (`addps`, `subps`,

`maxps...`), in addition to the 1-cycle latency `µops`. Thus, single-cycle `µops`, including `cjmp` `µop`, can be delayed more than in previous Pentium processors.

Throttling `cjmp` `µops` delays resolution of mispredicted `cjmp` `µops`. Potentially, this can increase the length of the speculation and possibly execute on an incorrect path. Use `cmov` instead of `cjmp` instruction. In the Streaming SIMD Extensions, the `cjmp` instruction can be emulated using a combination of `CMPPS` instruction and logical instructions.

Example 5-14 shows two loops: the first implements conditional branch instruction, the second omits this instruction.

#### Example 5-14 Scheduling with Emulated Conditional Branch

---

```
//Conditional branch included
loopMax:
    cmpnleps    xmm1, xmm0
    movmskps   eax, xmm1
    cmp eax, 0
    je noMax
maxFound:
    maxps      xmm0, [esi+ecx]
    andps     xmm1, xmm3
    maxps     xmm2, xmm1
noMax:
    add       ecx, 16
    addps    xmm3, xmm4
    movaps   xmm1, [esi+ecx]
    jnz     loopMax
// Use this structure for better scheduling
loopMax:
    cmpnleps    xmm5, xmm0
    maxps      xmm0, xmm1
    andps     xmm5, xmm3
    maxps     xmm2, xmm5
```

---

continued



---

**Example 5-14 Scheduling with Emulated Conditional Branch** (continued)

---

```

add      ecx, 16
addps   xmm3, xmm4
movaps  xmm1, [esi+ecx]
movaps  xmm5, xmm1
jnz     loopMax

```

---

The original code's performance depends on the number of mispredicted branches which in turn depends on the data being sorted, which contributes to a large value for clocks per instruction (CPI = 1.78). The second loop omits the conditional branch instruction, but does not balance the port loading. A further advantage of the new code is that the latency is independent of the data values being sorted.

## Port Balancing

To further reduce the CPI in the above example, balance the number of  $\mu$ ops issued on ports 0, 1, and 2. You can do so by replacing sections of the Streaming SIMD Extensions code with MMX technology code. In particular, calculation of the indices can be done with MMX instructions as follows:

- Create a mask with Streaming SIMD Extensions and store into memory.
- Convert this mask into MMX technology format using `movq` and `packssdw` instructions.
- Extract max indices using the MMX technology `pmaxsw`, `pand`, and `paddw` instructions.

The code in Example 5-15 demonstrates these steps.

**Example 5-15 Replacing the Streaming SIMD Extensions Code with the MMX Technology Code**

---

```
loopMax:
    cmpnleps xmm1, xmm0    ;create mask in Streaming SIMD
                          ;Extensions format
    maxps   xmm0, [esi+ecx];get max values

    movaps [esi+ecx], xmm1;store mask into memory
    movq   mm1, [esi+ecx];put lower part of mask into mm1
    add    ecx, 16        ;increment pointer
    movaps xmm1, [esi+ecx];load next four aligned floats
    packssdw mm1, [esi+ecx-8];pack lower and upper parts
                          ;of the mask

mask:
    pand    mm1, mm3 ;get indices mask of max values
    paddw   mm3, mm4 ;increment indices
    pmaxsw  mm2, mm1 ;get indices corresponding to max
                          ;values
    jnz     loopMax
```

---

Example 5-15 is the most optimal version of code for the Pentium III processor and has a CPI of 0.94. This example illustrates the importance of instruction usage to maximize port utilization. See Appendix C, “[Instruction to Decoder Specification](#),” for a table that details port assignments of the instructions in the Pentium III processor architecture.

Another example where replacing the Streaming SIMD Extensions code with the MMX technology code can give good results is the dot product operation. This operation is the primary operation in matrix multiplication that is used frequently in 3D applications and other floating-point applications.

The dot product kernel and optimization issues and considerations are presented in the following discussion. The code in Example 5-16 represents a typical dot product implementation.

### Example 5-16 Typical Dot Product Implementation

```

inner_loop:
    movaps    (%eax,%ecx,4),    %xmm0 // 1st
    movaps    (%ebx,%ecx,4),    %xmm1
    mulps     %xmm1,            %xmm0
    addps     %xmm0,            %xmm7
    movaps    16(%eax,%ecx,4),  %xmm2 // 2nd
    movaps    16(%ebx,%ecx,4),  %xmm3
    mulps     %xmm3,            %xmm2
    addps     %xmm2,            %xmm7
    movaps    32(%eax,%ecx,4),  %xmm4 // 3rd
    movaps    32(%ebx,%ecx,4),  %xmm5
    mulps     %xmm5,            %xmm4
    addps     %xmm4,            %xmm7
    movaps    48(%eax,%ecx,4),  %xmm6 // 4th
    movaps    48(%ebx,%ecx,4),  %xmm0
    mulps     %xmm6,            %xmm0
    addps     %xmm0,            %xmm7
    subl     $16,                %ecx // loop count
    jnz      inner_loop
    
```

The inner loop in the above example consists of eight loads, four multiplies and four additions. This translates into 16 `load`  $\mu$ ops, 8 `mul`  $\mu$ ops and 8 `add`  $\mu$ ops for Streaming SIMD Extensions and 8 `load`  $\mu$ ops, 4 `mul`  $\mu$ ops and 4 `add`  $\mu$ ops for MMX technology.

What are the characteristics of the dot product operation?

- Ratio of `load/mult/add`  $\mu$ ops is 2:1:1.
- Hardware `load/mult/add` ports is 1:1:1.
- Optimum balance of ports for `load/mult/add` is 1:1:1.
- Inner loop performance is limited by a single `load` port.

This kernel's performance can be improved by using optimization techniques to avoid performance loss due to hardware resource constraints. Since the optimum latency for the inner loop is 16 clocks, experimenting

with a large number of iterations can reduce branch penalties. Properly scheduled code achieves 16 clocks/iteration with a large number of iterations. But, only four iterations are present in the original code. The increase is caused by a BTB (branch target buffer) warm-up penalty that occurs in the beginning of the loop. A mispredicted branch occurs on the last iteration. The warm-up penalty and mispredicted branch combine to cause about 5 additional clocks/iteration. The cause of the performance loss is a short loop and a large number of loads.

## Streaming SIMD Extension Numeric Exceptions

This section discusses various aspects of the Streaming SIMD Extension numeric exceptions: conditions, priority, automatic masked exception handling, software exception handling with unmasked exceptions, interaction with x87 numeric exceptions, and the flush-to-zero mode.

### Exception Conditions

The numeric exception conditions that can occur when executing Streaming SIMD Extension instructions can be referred to as the following six classes:

- invalid operation (#I)
- divide-by-zero (#Z)
- denormalized operand (#D)
- numeric overflow (#O)
- numeric underflow (#U)
- inexact result (precision) (#P)

Invalid, divide-by-zero and denormal exceptions are precomputation exceptions; they are detected before any arithmetic operation occurs. Underflow, overflow and precision exceptions are post-computation exceptions.

When numeric exceptions occur, a processor supporting Streaming SIMD Extensions take one of two possible courses of action:

- The processor can handle the exception by itself, producing the most reasonable result and allowing numeric program execution to continue undisturbed (that is, masked exception response).
- A software exception handler can be invoked to handle the exception (that is, unmasked exception response).

Each of the six exception conditions described above has corresponding flag and mask bits in the **MXCSR**. Depending on the flag and mask bit values the following operations take place:

- If an exception is masked (mask bit in **MXCSR** = 1), the processor takes an appropriate default action and continues with the computation.
- If the exception is unmasked (mask bit in **MXCSR** = 0) and the operating system (OS) supports Streaming SIMD Extension exceptions (that is, **CR4.OSXMMEXCEPT** = 1), a software exception handler is invoked immediately through Streaming SIMD Extensions exception interrupt vector 19.
- If the exception is unmasked (mask bit in **MXCSR** = 0) and the OS does not support Streaming SIMD Extension exceptions (that is, **CR4.OSXMMEXCEPT** = 0), an invalid opcode exception is signalled instead of a Streaming SIMD Extensions exception.



---

**NOTE.** *Note that Streaming SIMD Extension exceptions exclude a situation when, for example, an x87 floating-point instruction, **fwait**, or a Streaming SIMD Extensions instruction catch a pending unmasked Streaming SIMD Extensions exception.*

---

## Exception Priority

The processor handles exceptions according to a predetermined precedence. The precedence for Streaming SIMD Extension numeric exceptions is as follows:

- Invalid-operation exception
- **QNaN** operand. Though this is not an exception, the handling of a **QNaN** operand has precedence over lower-priority exceptions. For example, a **QNaN** divided by zero results in a **QNaN**, not a zero-divide exception.
- Any other invalid-operation exception not mentioned above or a divide-by-zero exception
- Denormal-operand exception. If masked, then instruction execution continues, and a lower-priority exception can occur as well

- Numeric overflow and underflow exceptions in conjunction with the inexact-result exception
- Inexact-result exception

When a suboperand of a packed instruction generates two or more exception conditions, the exception precedence sometimes results in the higher-priority exception being handled and the lower-priority exceptions being ignored. For example, dividing an **SNaN** by zero can potentially signal an invalid-arithmetic-operand exception (due to the **SNaN** operand) and a divide-by-zero exception. Here, if both exceptions are masked, the processor handles the higher-priority exception only (the invalid-arithmetic-operand exception), returning a real indefinite to the destination.

Alternately, a denormal-operand or inexact-result exception can accompany a numeric underflow or overflow exception, with both exceptions being handled. Prioritizing of exceptions is performed only on a individual sub-operand basis, and not between suboperands. For example, an invalid exception generated by one sub-operand will not prevent the reporting of a divide-by-zero exception generated by another sub-operand.

## Automatic Masked Exception Handling

If the processor detects an exception condition for a masked exception, it delivers a predefined default response and continues executing instructions. The masked (default) responses to exceptions deliver a reasonable result for each exception condition and are generally satisfactory for most application code. By masking or unmasking specific floating-point exceptions in the MXCSR, programmers can delegate responsibility for most exceptions to the processor and reserve the most severe exception conditions for software exception handlers.

Because the exception flags are “sticky,” they provide a cumulative record of the exceptions that have occurred since they were last cleared. A programmer can thus mask all exceptions, run a calculation, and then inspect the exception flags to see if any exceptions were detected during the calculation.

Note that when exceptions are masked, the processor may detect multiple exceptions in a single instruction, because:

- Execution continues after performing its masked response; for example, the processor could detect a denormalized operand, perform its masked response to this exception, and then detect an underflow.
- Some exceptions occur naturally in pairs, such as numeric underflow and inexact result (precision).
- Packed instructions can produce independent exceptions on each pair of operands.

## Software Exception Handling - Unmasked Exceptions

Most of the masked exceptions in Streaming SIMD Extensions are handled by hardware without penalty except denormals and underflow. But these can also be handled without penalty if flush-to-zero mode is used.

Your application must ensure that the operating system supports unmasked exceptions before unmasking any of the exceptions in the `MXCSR` (see [“Checking for Processor Support of Streaming SIMD Extensions and MMX™ Technology” in Chapter 3](#)).

If the processor detects a condition for an unmasked Streaming SIMD Extensions application exception, a software handler is invoked immediately at the end of the excepting instruction. The handler is invoked through the Streaming SIMD Extensions exception interrupt (vector 19), irrespective of the state of the `CR0.NE` flag. If an exception is unmasked, but Streaming SIMD Extension unmasked exceptions are not enabled (`CR4.OSXMMEXCPT = 0`), an invalid opcode fault is generated. However, the corresponding exception bit will still be set in the `MXCSR`, as it would be if `CR4.OSXMMEXCPT = 1`, since the invalid opcode handler/user needs to determine the cause of the exception.

A typical action of the exception handler is to store x87 floating-point and Streaming SIMD Extensions state information in memory (with the `fxsave/fxrstor` instructions) so that it can evaluate the exception and formulate an appropriate response. Other typical exception handler actions can include:

- Examining stored x87 floating-point and Streaming SIMD Extensions state information (control/status) to determine the nature of the error.

- Taking action to correct the condition that caused the error.
- Clearing the exception bits in the x87 floating-point status word (**FSW**) or the Streaming SIMD Extensions control register (**MXCSR**).
- Returning to the interrupted program and resuming normal execution.

In lieu of writing recovery procedures, the exception handler can do the following:

- Increment in software an exception counter for later display or printing.
- Print or display diagnostic information (such as the Streaming SIMD Extensions register state).
- Halt further program execution.

When an unmasked exception occurs, the processor will not alter the contents of the source register operands prior to invoking the unmasked handler. Similarly, the integer **EFLAGS** will also not be modified if an unmasked exception occurs while executing the **comiss** or **ucomiss** instructions. Exception flags will be updated according to the following rules:

- Exception flag updates are generated by a logical-OR of exception conditions for all sub-operand computations, where the OR is done independently for each type of exception. For packed computations, this means four suboperands; for scalar computations this means 1 sub-operand (the lowest one).
- In the case of only masked exception conditions, all flags will be updated.
- In the case of an unmasked precomputation type of exception condition (that is, denormal input), all flags relating to all precomputation conditions (masked or unmasked) will be updated, and no subsequent computation is performed (that is, no post-computation condition can occur if there is an unmasked pre-computation condition).
- In the case of an unmasked post-computation exception condition, all flags relating to all post-computation conditions (masked or unmasked) will be updated; all precomputation conditions, which must be masked, will also be reported.





---

**NOTE.** *In certain cases, if any numerical exception is unmasked, the retirement rate might be affected and reduced. This might happen when Streaming SIMD Extensions code is scheduled without large impact of the dependency and with the intention to have maximum execution rate. Usually such code consists of balanced operations such as packed floating-point multiply, add and load or store (or a mix that includes balanced 2 arithmetic operation/load or store with MMX technology or integer instructions).*

---

## Interaction with x87 Numeric Exceptions

The Streaming SIMD Extensions control/status register was separated from its x87 floating-point counterparts to allow for maximum flexibility. Consequently, the Streaming SIMD Extensions architecture is independent of the x87 floating-point architecture, but has the following implications for x87 floating-point applications that call Streaming SIMD Extensions-enabled libraries:

- The x87 floating-point rounding mode specified in **FCW** will not apply to calls in a Streaming SIMD Extensions library, unless the rounding control in **MXCSR** is explicitly set to the same mode.
- x87 floating-point exception observability may not apply to a Streaming SIMD Extensions library.
- An application that expects to catch x87 floating-point exceptions that occur in an x87 floating-point library will not be notified if an exception occurs in a corresponding Streaming SIMD Extensions library, unless the exception masks, enabled in **FCW**, have also been enabled in **MXCSR**.
- An application will not be able to unmask exceptions after returning from a Streaming SIMD Extensions library call to detect if an error occurred. A Streaming SIMD Extensions exception flag that was set when the corresponding exception was unmasked will not generate a fault; only the next occurrence of that exception will generate an unmasked fault.

- An application which checks **FSW** to determine if any masked exception flags were set during an x87 floating-point library call will also need to check **MXCSR** in order to observe a similar occurrence of a masked exception within a Streaming SIMD Extensions library.

### Use of **CVTTPS2PI/CVTSS2SI** Instructions

The **cvttps2pi** and **cvttss2si** instructions encode the truncate/chop rounding mode implicitly in the instruction, thereby taking precedence over the rounding mode specified in the **MXCSR** register. This behavior can eliminate the need to change the rounding mode from round-nearest, to truncate/chop, and then back to round-nearest to resume computation. Frequent changes to the **MXCSR** register should be avoided since there is a penalty associated with writing this register; typically, through the use of the **cvttps2pi** and **cvttss2si** instructions, the rounding control in **MXCSR** can be always be set to round-nearest.

## Flush-to-Zero Mode

Activating the flush-to-zero mode has the following effects during underflow situations:

- Zero result is returned when the result is true.
- Precision and underflow exception flags are set to 1.

The IEEE mandated response to underflow is to deliver the denormalized result (that is, gradual underflow); consequently, the flush-to-zero mode is not compatible with IEEE Standard 754. It is provided for applications where underflow is common. Underflow for flush-to-zero mode occurs when the exponent for a computed result falls in the denormal range, regardless of whether a loss of accuracy has occurred.

Unmasking the underflow exception takes precedence over flush-to-zero mode. For a Streaming SIMD Extensions instruction that generates an underflow condition an exception handler is invoked. Unmasking the underflow exception occurs, regardless of whether flush-to-zero mode is enabled.

# *Optimizing Cache Utilization for Pentium® III Processors*

---

# 6

Over the past decade, processor speed has increased more than ten times, while memory access speed has increased only slightly. Many applications can considerably improve their performance if data resides in caches so the processor does not have to wait for the data from memory.

Until now, techniques to bring data into the processor before it was needed involved additional programming. These techniques were not easy to implement, or required special steps to prevent from degrading performance. The Streaming SIMD Extensions address these issues by providing the prefetch instruction and its variations. Prefetching is a much better mechanism to ensure that data are in the cache when requested.

The prefetch instruction, controlled by the programs or compilers, retrieves a minimum of 32 bytes of data prior to the data actually being needed. This hides the latency for data access in the time required to process data already resident in the cache. Many algorithms can provide information in advance about the data that is to be required soon. The new instruction set also features non-temporal store instructions to minimize the performance issues caused by cache pollution.

This chapter focuses on two major subjects:

- Prefetch and Cacheability Instructions—describes instructions that allow you to implement a data caching strategy.
- Memory Optimization Using Prefetch—describes and provides examples of various techniques for implementing prefetch instructions.

Note that in a number of cases presented in this chapter, the prefetching and cache utilization are platform-specific and may change for future processors.

## Prefetch and Cacheability Instructions

The new cacheability control instructions allow you to control data caching strategy in order to increase cache efficiency and minimize cache pollution.

Data can be viewed by time and address space characteristics as follows:

Temporal	data will be used again soon
Spatial	data will be used in adjacent locations, for example, the same cache line
Non-temporal	data which are referenced once and not reused in the immediate future; for example, some multimedia data types, such as the vertex buffer in a 3D graphics application

These data characteristics are used in the discussion that follows.

### The Prefetching Concept

The `prefetch` instruction can hide the latency of data accesses in performance-critical sections of application code by allowing data to be fetched in advance of its actual usage. The `prefetch` instructions do not change the user-visible semantics of a program, although they may affect the program's performance. The `prefetch` instructions merely provide hints to the hardware and generally do not generate exceptions or faults.

The `prefetch` (load 32 or greater number of bytes) instructions load either non-temporal data or temporal data in the specified cache level. This data access type and the cache level are specified as hints. Depending on the implementation, the instruction fetches 32 or more aligned bytes, including the specified address byte, into the instruction-specified cache levels.



---

**NOTE.** Using the `prefetch` instructions is recommended only if data does not fit in cache.

---

Generally the `prefetch` instructions only provide hints to the hardware and do not generate exceptions or faults except for a special case described in the [“Prefetch and Load Instructions”](#) section. However, excessive use of prefetch instructions may waste memory bandwidth and result in a performance penalty due to resource constraints.

Nevertheless, the prefetch instructions can lessen the overhead of memory transactions by preventing cache pollution, and by using the cache and memory efficiently. This is particularly important for the applications that share critical system resources, such as memory bus. See an example in [“Video Encoder”](#) section.

## The Prefetch Instructions

The Streaming SIMD Extensions include four types of `prefetch` instructions corresponding to four prefetching hints to the processor: one non-temporal, and three temporal. They correspond to two types of operations, temporal and non-temporal.



---

**NOTE.** *If the data are already found in a cache level that is closer to the processor at the time of `prefetch`, no data movement occurs.*

---

The non-temporal instruction is

`prefetchnta`     fetch data into location closest to the processor, minimizing cache pollution. On the Pentium® III processor, this is the L1 cache.

The temporal instructions are

`prefetcht0`     fetch data into all cache levels, that is to L1 and L2 for Pentium III processors

`prefetcht1`     fetch data into all cache levels except the 0<sup>th</sup> level, that is to L2 only on Pentium III processors

`prefetcht2`     fetch data into all cache levels except the 0<sup>th</sup> and 1<sup>st</sup> levels, that is, to L2 only on Pentium III processors

In the description above, cache level 0 is closest to the processor. For Streaming SIMD Extensions implementation, there are only two cache levels, L1 and L2. L1 is the 0<sup>th</sup> cache level by the architectural definition, as a result, `prefetcht1` and `prefetcht2` are designed to behave the same in Pentium® III processor. For future processors, this may change.

`Prefetchnta` with Streaming SIMD Extensions implementation fetches data into L1 only, therefore minimizing L2 cache pollution.

`Prefetch` instructions are mainly designed to improve application performance by hiding memory latency in the background. If segments of an application access data in a predictable manner, for example, using arrays with known strides, then they are good candidates for using prefetch to improve performance. However, if a program is memory throughput bound, that is, memory access time is much larger than execution time, then there may be not much benefit from utilizing prefetch.

Basically, use `prefetch` in:

- predictable memory access patterns
- time-consuming innermost loops
- locations where execution pipeline stalls for data from memory due to flow dependency

## Prefetch and Load Instructions

The Pentium II and Pentium III processors have a decoupled execution and memory architecture that allows instructions to be executed independently with memory accesses if there is no data and resource dependency.

Programs or compilers can use dummy load instructions to imitate prefetch functionality, but preloading is not equivalent to prefetching. Prefetch instructions provide a greater performance than preloading.

Currently, the `prefetch` instruction provides a greater performance gain than preloading because it:

- has no register destination, it only updates cache lines;
- does not stall the normal instruction retirement;
- does not affect the functional behavior of the program;
- has no cache line split accesses;

- does not cause exceptions except when the **LOCK** prefix is used; for Pentium III processors, an invalid opcode exception is generated when the **LOCK** prefix is used with prefetch instructions;
- does not complete its own execution if that would cause a fault;
- is ignored if the **prefetch** targets an uncacheable memory region, for example, USWC and UC;
- does not perform a page table walk if it results in a page miss.

The current advantages of the prefetch over preloading instructions are processor-specific. The nature and extent of the advantages may change in the future.

## The Non-temporal Store Instructions

The non-temporal store instructions (**movntps**, **movntq**, and **maskmovq**) minimize cache pollution while writing data. The main difference between a non-temporal store and a regular cacheable store is in the write-allocation behavior: the processor will fetch the corresponding cache line into the cache hierarchy prior to performing the store and the memory type can take precedence over the non-temporal hint.

Currently, if you specify a non-temporal store to cacheable memory, they must maintain coherency. Two cases may occur:

- If the data are present in the cache hierarchy, the data are updated in-place and the existing memory type attributes are retained. For example, in Streaming SIMD Extensions implementation, if there is a data hit in L1, then non-temporal stores behave like regular stores. Otherwise, write to memory without cache line allocation. If the data are found in L2, data in L2 will be invalidated.
- If the data are not present in the cache hierarchy, the memory type visible on the bus will remain unchanged, and the transaction will be weakly-ordered; consequently, you are responsible for maintaining coherency. Non-temporal stores will not write allocate. Different implementations may choose to collapse and combine these stores inside the processor.

The behavior described above is platform-specific and may change in the future.

## The `sfence` Instruction

The `sfence` (`store fence`) instruction makes it possible for every `store` instruction that precedes the `sfence` instruction in program order to be globally visible before any `store` instruction that follows the `fence`. The `sfence` instruction provides an efficient way of ensuring ordering between routines that produce weakly-ordered results.

The use of weakly-ordered memory types can be important under certain data sharing relationships, such as a producer-consumer relationship. Using weakly-ordered memory can make assembling the data more efficient, but care must be taken to ensure that the consumer obtains the data that the producer intended to see. Some common usage models may be affected in this way by weakly-ordered stores. Examples are:

- library functions, which use weakly-ordered memory to write results
- compiler-generated code, which also benefits from writing weakly-ordered results
- hand-crafted code

The degree to which a consumer of data knows that the data is weakly-ordered can vary for these cases. As a result, the `sfence` instruction should be used to ensure ordering between routines that produce weakly-ordered data and routines that consume this data. The `sfence` instruction provides a performance-efficient way by ensuring the ordering when every `store` instruction that precedes the `store fence` instruction in program order is globally visible before any `store` instruction which follows the `fence`.

## Streaming Non-temporal Stores

In Streaming SIMD Extensions, the `movntq`, `movnts` and `maskmovq` instructions are streaming, non-temporal stores. With regard to memory characteristics and ordering, they are similar mostly to the Write-Combining (`WC`) memory type:

- Write combining – successive writes to the same cache line are combined
- Write collapsing – successive writes to the same byte(s) result in only the last write being visible



- Weakly ordered – no ordering is preserved between **WC** stores, or between **WC** stores and other loads or stores
- Uncacheable and not write-allocating – stored data is written around the cache and will not generate a read-for-ownership bus request for the corresponding cache line.

Because streaming stores are weakly ordered, a fencing operation is required to ensure that the stored data is flushed from the processor to memory. Failure to use an appropriate fence may result in data being “trapped” within the processor and will prevent visibility of this data by other processors or system agents. **WC** stores require software to ensure coherence of data by performing the fencing operation.

Streaming SIMD Extensions introduce the **sfence** instruction, which now is solely used to flush **WC** data from the processor. The **sfence** instruction replaces all other store fencing instructions such as **xchg**.

Streaming stores can improve performance in the following ways:

- Increase store bandwidth since they do not require read-for-ownership bus requests
- Reduce disturbance of frequently used cached (temporal) data, since they write around the processor caches

Streaming stores allow cross-aliasing of memory types for a given memory region; for instance, a region may be mapped as write-back (**WB**) via the page tables (**PAT**) or memory type range registers (**MTRRS**) and yet is written using a streaming store.

If a streaming store finds the corresponding line already present in the processor’s caches, several actions may be taken depending on the specific processor implementation:

- |            |  |
|------------|--|
| Approach A | The streaming store may be combined with the existing cached data, and is thus treated as a <b>WB</b> store (that is, it is not written to system memory). |
| Approach B | The corresponding line may be flushed from the processor’s caches, along with data from the streaming store.   |

Pentium III processor implements a combination of both approaches. If the streaming store hits a line that is present in the L1 cache, the store data will be combined in place within the L1. If the streaming store hits a line present in the L2, the line and stored data will be flushed from the L2 to system memory. Note that the approaches, separate or combined, can be different for future processors.

The two primary usage domains for streaming store are coherent requests and non-coherent requests.

## Coherent Requests

Coherent requests are normal loads and stores to system memory, which may also hit cache lines present in another processor in a multi-processor environment. With coherent requests, a streaming store can be used in the same way as a regular store that has been mapped with a **WC** memory type (**PAT** or **MTRR**). An **sfence** instruction must be used within a producer-consumer usage model, in order to ensure coherency and visibility of data between processors. Within a single-processor system, the CPU can also re-read the same memory location and be assured of coherence (that is, a single, consistent view of this memory location): the same is true for a multi-processor (MP) system, assuming an accepted MP software producer-consumer synchronization policy is employed.

## Non-coherent Requests

Non-coherent requests arise from an I/O device, such as an AGP graphics card, that reads or writes system memory using non-coherent requests, which are not reflected on the processor bus and thus will not query the processor's caches. An **sfence** instruction must be used within a producer-consumer usage model, in order to ensure coherency and visibility of data between processors. In this case, if the processor is writing data to

the I/O device, a streaming store can be used with a processor with any behavior of approach A, above, only if the region has also been mapped with a **WC** memory type (**PAT**, **MTRR**).



---

**CAUTION.** *Failure to map the region as **WC** may allow the line to be speculatively read into the processor caches, that is, via the wrong path of a mispredicted branch.*

---

In case the region is not mapped as **WC**, the streaming might update in-place in the cache and a subsequent **sfence** would not result in the data being written to system memory. Explicitly mapping the region as **WC** in this case ensures that any data read from this region will not be placed in the processor's caches. A read of this memory location by a non-coherent I/O device would return incorrect/out-of-date results. For a processor which solely implements approach B, above, a streaming store can be used in this non-coherent domain without requiring the memory region to also be mapped as **WB**, since any cached data will be flushed to memory by the streaming store.

## Other Cacheability Control Instructions

The **maskmovq** (non-temporal byte mask store of packed integer in an MMX™ technology register) instruction stores data from an MMX technology register to the location specified by the **edi** register. The most significant bit in each byte of the second MMX technology mask register is used to selectively write the data of the first register on a per-byte basis. The instruction is implicitly weakly-ordered (that is, successive stores may not write memory in original program-order), does not write-allocate, and thus minimizes cache pollution.

The **movntq** (non-temporal store of packed integer in an MMX technology register) instruction stores data from an MMX technology register to memory. The instruction is implicitly weakly-ordered, does not write-allocate, and so minimizes cache pollution.

The `movntps` (non-temporal store of packed single precision floating point) instruction is similar to `movntq`. It stores data from a Streaming SIMD Extensions register to memory in 16 byte granularity. Unlike `movntq`, the memory address must be aligned to a 16-byte boundary; or a general protection exception will occur. The instruction is implicitly weakly-ordered, does not write-allocate, and thus minimizes cache pollution.

## Memory Optimization Using Prefetch

Achieving the highest level of memory optimization using prefetch instructions requires an understanding of the micro-architecture and system architecture of a given machine. This section translates the key architectural implications into several simple guidelines for programmers to use.

Figure 6-1 and Figure 6-2 show two scenarios of a simplified 3D geometry pipeline as an example. A 3D-geometry pipeline typically fetches one vertex record at a time and then performs transformation and lighting functions on it. Both figures show two separate pipelines, an execution pipeline, and a memory pipeline (front-side bus). Since the Pentium II and Pentium III processors completely decouple the functionality of execution and memory access, these two pipelines can function concurrently. Figure 6-1 shows “bubbles” in both the execution and memory pipelines. When loads are issued for accessing vertex data, the execution units sit idle and wait until data is returned. On the other hand, the memory bus sits idle while the execution units are processing vertices. This scenario severely decreases the advantage of having a decoupled architecture.

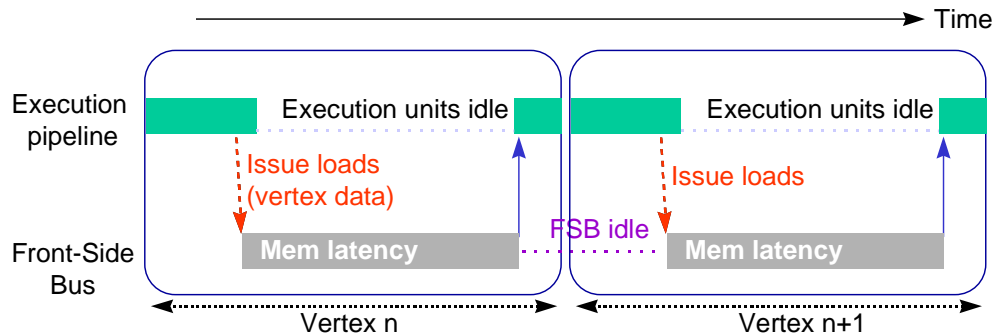
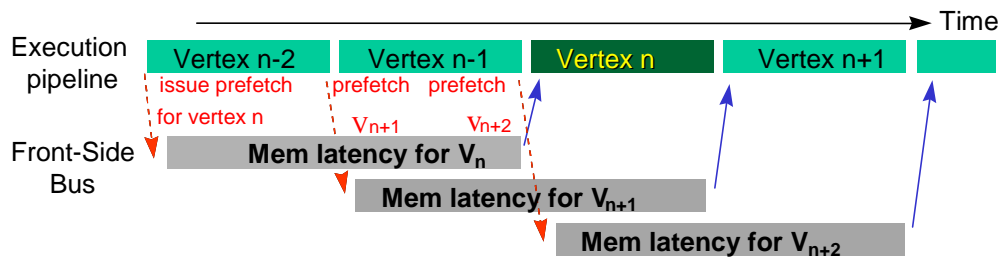
**Figure 6-1 Memory Access Latency and Execution Without Prefetch****Figure 6-2 Memory Access Latency and Execution With Prefetch**

The performance loss caused by poor utilization of the resource can be completely eliminated by applying prefetch instructions appropriately. As shown in Figure 6-2, prefetch instructions are issued two vertex iterations ahead. This assumes that only one vertex gets processed in one iteration and a new data cache line is needed for each iteration. As a result, when iteration  $n$ , vertex  $V_n$ , is being processed, the requested data is already brought into cache. In the meantime, the front-side bus is transferring the data needed for  $n+1$  iteration, vertex  $V_{n+1}$ . Because there is no dependency between  $V_{n+1}$  data and the execution of  $V_n$ , the latency for data access of  $V_{n+1}$  can be entirely hidden behind the execution of  $V_n$ . Under such circumstances, no “bubbles” are present in the pipelines and thus the best possible performance can be achieved.

The software-controlled prefetch instructions provided in Streaming SIMD Extensions not only hide the latency of memory accesses if properly scheduled, but also allow you to specify where in the cache hierarchy the data should be placed. Prefetching is useful for inner loops that have heavy computations, or are close to the boundary between being compute-bound and memory-bandwidth-bound. The prefetch is probably not very useful for loops which are predominately memory bandwidth-bound. When data are already located in the 0<sup>th</sup> level cache, prefetching can be useless and could even slow down the performance because the extra  $\mu$ ops either back up waiting for outstanding memory accesses or may be dropped altogether. This behavior is platform-specific and may change in the future.

## Prefetching Usage Checklist

To use the prefetch instruction properly, check whether the following issues are addressed and/or resolved:

- prefetch scheduling distance
- prefetch concatenation
- minimize the number of prefetches
- mixing prefetch with computation instructions
- cache blocking techniques (for example, strip mining)
- single-pass versus multi-pass execution
- memory bank conflict issues
- cache management issues

The subsequent sections discuss all the above items.

## Prefetch Scheduling Distance

Determining the ideal prefetch placement in the code depends on many architectural parameters, including the amount of memory to be prefetched, cache lookup latency, system memory latency, and estimate of computation cycle. The ideal distance for prefetching data is processor- and platform-dependent. If the distance is too short, the prefetch will not effectively hide the latency of the fetch behind computation. If the prefetch is too far ahead, the start-up cost for data not prefetched for initial iterations diminishes the benefits of prefetching the data. Also, the prefetched data may wrap around and dislodge previously prefetched data prior to its actual use.

Since prefetch distance is not a well-defined metric, for this discussion, we define a new term, “prefetch scheduling distance (PSD),” which is represented in the number of iterations. For large loops, prefetch scheduling distance can be set to 1, that is, schedule prefetch instructions one iteration ahead. For small loops, that is, loop iterations with little computation, the prefetch scheduling distance must be more than one.

A simplified equation to compute PSD is deduced from the mathematical model. For a simplified equation, complete mathematical model, and detailed methodology of prefetch distance determination, refer to Appendix F, “[The Mathematics of Prefetch Scheduling Distance](#).”

In Example 6-1, the prefetch scheduling distance is set to 3.

---

### Example 6-1 Prefetch Scheduling Distance

---

```
top_loop:
    prefetchnta [edx + esi + 32*3]
    prefetchnta [edx*4 + esi + 32*3]
    . . . . .
    movaps     xmm1, [edx + esi]
    movaps     xmm2, [edx*4 + esi]
    movaps     xmm3, [edx + esi + 16]
    movaps     xmm4, [edx*4 + esi + 16]
    . . . . .
    . . . . .
    add        esi, 32
    cmp        esi, ecx
    jl         top_loop
```

---

### Prefetch Concatenation

De-pipelining memory generates bubbles in the execution pipeline. To explain this performance issue, a 3D geometry pipeline processing 3D vertices in strip format is used. A strip contains a list of vertices whose predefined vertex order forms contiguous triangles.

It can be easily observed that the memory pipe is de-pipelined on the strip boundary due to ineffective prefetch arrangement. The execution pipeline is stalled for the beginning 2 iterations for each strip. As a result, the average latency for completing an iteration will be 165 clocks. (See Appendix F, “[The Mathematics of Prefetch Scheduling Distance](#),” for detailed memory pipeline description.)

This memory de-pipelining creates inefficiency in both the memory pipeline and execution pipeline. This de-pipelining effect can be removed by applying a technique called prefetch concatenation. With this technique, the memory access and execution can be fully pipelined and fully utilized.

For nested loops, memory de-pipelining could occur during the interval between the last iteration of an inner loop and the next iteration of its associated outer loop. Without paying special attention to prefetch insertion, the loads from the first iteration of an inner loop can miss the cache and stall the execution pipeline waiting for data returned, thus degrading the performance.

In the code of Example 6-2, the cache line containing `a[ii][0]` is not prefetched at all and always misses the cache. This assumes that no array `a[][]` footprint resides in the cache. The penalty of memory de-pipelining stalls can be amortized across the inner loop iterations. However, it may become very harmful when the inner loop is short. In addition, the last prefetch of the inner loop is wasted and consumes machine resources. Prefetch concatenation is introduced here in order to eliminate the performance issue of memory de-pipelining.

### Example 6-2 Using Prefetch Concatenation

---

```
for (ii = 0; ii < 100; ii++) {  
    for (jj = 0; jj < 32; jj+=8) {  
        prefetch a[ii][jj+8]  
        computation a[ii][jj]  
    }  
}
```

---



Prefetch concatenation can bridge the execution pipeline bubbles between the boundary of an inner loop and its associated outer loop. Simply by unrolling the last iteration out of the inner loop and specifying the effective prefetch address for data used in the following iteration, the performance loss of memory de-pipelining can be completely removed. The re-written code is demonstrated in Example 6-3.

### Example 6-3 Concatenation and Unrolling the Last Iteration of Inner Loop

---

```
for (ii = 0; ii < 100; ii++) {  
    for (jj = 0; jj < 24; jj+=8) {  
        prefetch a[ii][jj+8]  
        computation a[ii][jj]  
    }  
    prefetch a[ii+1][0]  
    computation a[ii][jj]  
}
```

---

This code segment for data prefetching is improved, and only the first iteration of the outer loop suffers any memory access latency penalty, assuming the computation time is larger than the memory latency. Inserting a prefetch of the first data element needed prior to entering the nested loop computation would eliminate or reduce the start-up penalty for the very first iteration of the outer loop. This uncomplicated high-level code optimization can improve memory performance significantly.

### Minimize Number of Prefetches

Prefetch instructions are not completely free in terms of bus cycles, machine cycles and resources, even though they require minimal clocks and memory bandwidth.

Excessive prefetching may lead to the following situations:

- If the fill buffer is full, prefetches accumulate inside the load buffer waiting for the next fill buffer entry to be deallocated.
- If the load buffer is full, instruction allocation stalls.
- If the target loops are small, excessive prefetching may impose extra overhead.

A fill buffer is a temporary space allocated for cache line read from or write to memory. A load buffer is a scratch pad buffer used by the memory subsystem to impose access ordering on memory loads.

One approach to solve the excessive prefetching issue is to unroll and/or software-pipeline the loops to reduce the number of prefetches required. Example 6-4 shows a code example that implements prefetch and unrolls the loop to remove the redundant prefetch instructions whose prefetch addresses hit the previously issued prefetch instructions. In this particular example, unrolling the original loop once saves two prefetch instructions and three instructions for each conditional jump in every other iteration.

### Example 6-4 Prefetch and Loop Unrolling

<pre> top_loop: prefetchnta [edx+esi+32] prefetchnta [edx*4+esi+32] . . . . . movaps xmm1, [edx+esi] movaps xmm2, [edx*4+esi] . . . . . add esi, 16 cmp esi, ecx jl top_loop </pre>	<pre> top_loop: prefetchnta [edx+esi+32] prefetchnta [edx*4+esi+32] . . . . . movaps xmm1, [edx+esi] movaps xmm2, [edx*4+esi] . . . . . movaps xmm1, [edx+esi+16] movaps xmm2, [edx*4+esi+16] . . . . . add esi, 32 cmp esi, ecx jl top_loop </pre>
---	---

unrolled iteration

### Mix Prefetch with Computation Instructions

It may seem convenient to insert all the prefetch instructions at the beginning of a loop, but this can lead to severe performance degradation. In order to achieve best possible performance, prefetch instructions must be interspersed with other computational instructions in the instruction

sequence rather than clustered together. This improves the instruction level parallelism and reduces the potential instruction allocation stalls due to the load-buffer-full problem mentioned earlier. It also allows potential dirty writebacks (additional bus traffic caused by evicting modified cache lines from the cache) to proceed concurrently with other instructions.

Example 6-5 illustrates mixing prefetch instructions. A simple and useful heuristic of prefetch spreading for a 500 MHz Pentium III processor is to insert a prefetch instruction every 20 to 25 cycles. Rearranging prefetch instructions could yield a noticeable speedup for the code which is limited in cache resource.

### Example 6-5 Spread Prefetch Instructions

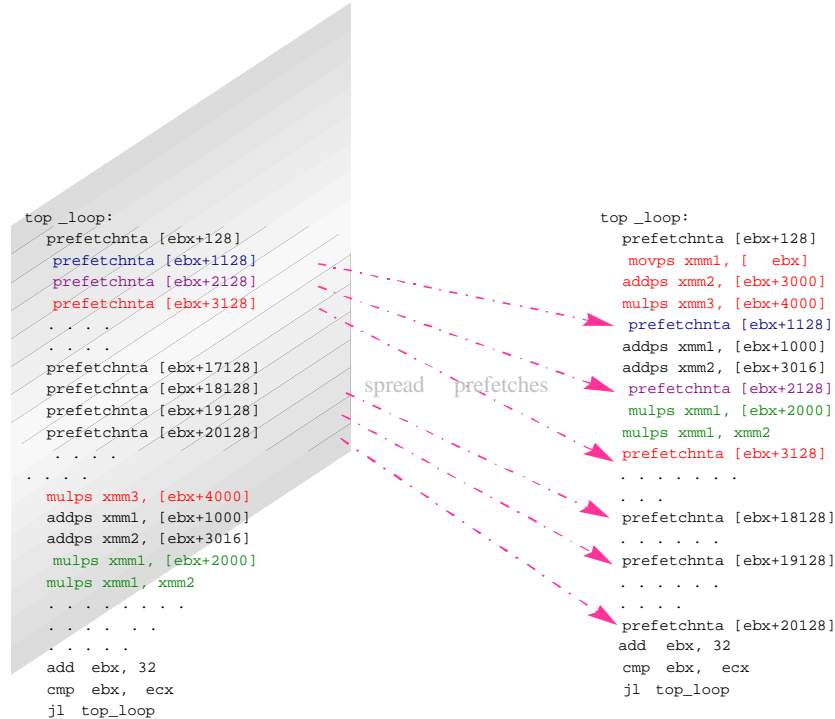

If all fill buffer entries are full, the next transaction waits inside the load buffer or store buffer. A prefetch operation cannot complete until a fill buffer entry is allocated. The load buffers are shared by normal load  $\mu$ ops and outstanding prefetches.



---

**NOTE.** *To avoid instruction allocation stalls due to a load buffer full condition when mixing prefetch instructions, prefetch instructions must be interspersed with computational instructions.*

---

## Prefetch and Cache Blocking Techniques

Cache blocking techniques, such as strip-mining, are used to improve temporal locality, and thereby, cache hit rate. Strip-mining is a one-dimensional temporal locality optimization for memory. When two-dimensional arrays are used in programs, loop blocking techniques (similar to strip-mining but in two dimensions) can be applied for better memory performance.

If an application uses a large data set that can be reused across multiple passes of a loop, it will benefit from strip mining: data sets larger than the cache will be processed in groups small enough to fit into cache. This allows temporal data to reside in the cache longer, reducing bus traffic.

Data set size and temporal locality (data characteristics) fundamentally affect how prefetch instructions are applied to strip-mined code. shows two simplified scenarios for temporally adjacent data and temporally non-adjacent data.

---

**Figure 6-3 Cache Blocking - Temporally Adjacent and Non-adjacent Passes**

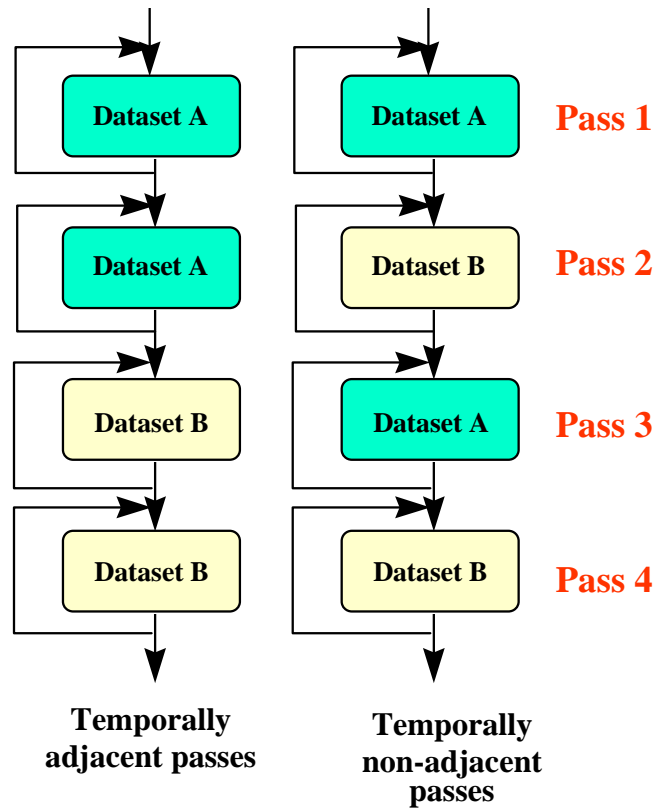

---



In the temporally adjacent scenario, subsequent passes use the same data and find it ready in L1 cache. Prefetch issues aside, this is the preferred situation. In the temporally non-adjacent scenario, data used in pass  $m$  is displayed by pass  $(m+1)$ , requiring data *re-fetch* if a later pass reuses the data. Both data sets could still fit into L2 cache, so load operations in passes 3 and 4 become less expensive.

Figure 6-4 shows how prefetch instructions and strip-mining can be applied to increase performance in both of these scenarios.

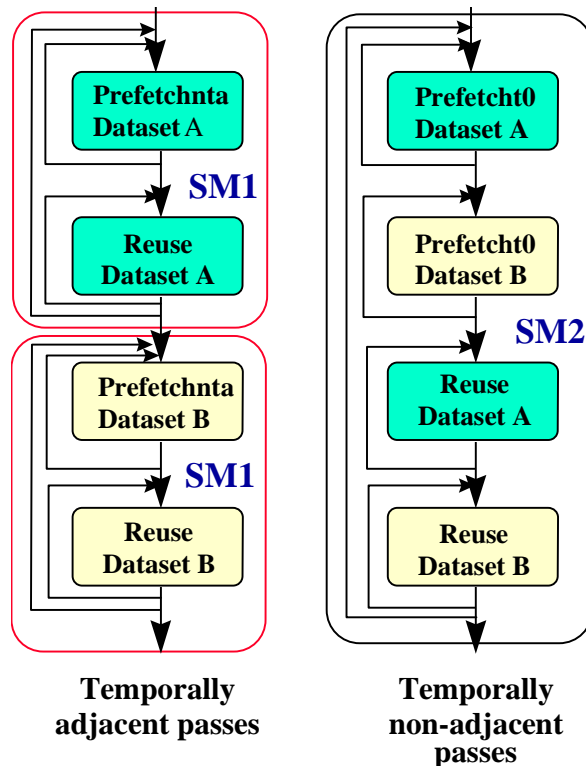
**Figure 6-4 Examples of Prefetch and Strip-mining for Temporally Adjacent and Non-adjacent Passes Loops**



For Pentium III processors, the left scenario shows a graphical implementation of using `prefetchnta` to prefetch data into the L1 cache **only** (SM1 - strip mine L1), minimizing L2 cache pollution. Use `prefetchnta` if the data set fits into L1 cache or if the data is only touched once during the entire execution pass in order to minimize cache pollution in the higher level caches. This provides instant availability when the read access is issued and minimizes L2 cache pollution.

In the right scenario, keeping the data in L1 cache does not improve cache locality. Therefore, use `prefetcht0` to prefetch the data. This hides the latency of the memory references in passes 1 and 2, and keeps a copy of the

data in L2 cache, which reduces memory traffic and latencies for passes 3 and 4. To further reduce the latency, it might be worth considering extra `prefetchnta` instructions prior to the memory references in passes 3 and 4.

In Example 6-6, consider the data access patterns of a 3D geometry engine first without strip-mining and then incorporating strip-mining. Note that 4-wide SIMD instructions of Pentium III processors can process 4 vertices per every iteration.

### Example 6-6 Data Access of a 3D Geometry Engine without Strip-mining

---

```
while (nvtx < MAX_NUM_VTX) {
    prefetchnta vertexi data // v =[x,y,z,nx,ny,nz,tu,tv]
    prefetchnta vertexi+1 data
    prefetchnta vertexi+2 data
    prefetchnta vertexi+3 data
    TRANSFORMATION code // use only x,y,z,tu,tv of a
vertex
    nvtx+=4
}
while (nvtx < MAX_NUM_VTX) {
    prefetchnta vertexi data // v =[x,y,z,nx,ny,nz,tu,tv]
    prefetchnta vertexi+1 data
    prefetchnta vertexi+2 data
    prefetchnta vertexi+3 data
    compute the light vectors // use only x,y,z
    POINT LIGHTING code // use only nx,ny,nz
    nvtx+=4
}
```

---

Without strip-mining, all four vertices of the lighting loop must be re-fetched from memory in the second pass. This causes under-utilization of cache lines fetched during the transformation loop as well as extra bandwidth wasted in the lighting loop. Now consider the code in Example 6-7 where strip-mining has been incorporated into the loops.

## Example 6-7 Data Access of a 3D Geometry Engine with Strip-mining

---

```

while (nstrip < NUM_STRIP) {
/* Strip-mine the loop to fit data into L1 */
  while (nvtx < MAX_NUM_VTX_PER_STRIP) {
    prefetchnta vertexi data // v=[x,y,z,nx,ny,nz,tu,tv]
    prefetchnta vertexi+1 data
    prefetchnta vertexi+2 data
    prefetchnta vertexi+3 data
    TRANSFORMATION code
    nvtx+=4
  }
while (nvtx < MAX_NUM_VTX_PER_STRIP) {
  /* x y z coordinates are in L1, no prefetch is
required */
  compute the light vectors
  POINT LIGHTING code
  nvtx+=4
}
}

```

---

With strip-mining, all the vertex data can be kept in the cache (for example, L1) during the strip-mined transformation loop and reused in the lighting loop. Keeping data in the cache reduces both bus traffic and the number of prefetches used.

Figure 6-5 summarizes the steps of the basic usage model incorporating prefetch with strip-mining which are:

- Do strip-mining: partition loops so that the data set fits into L1 cache (preferred) or L2 cache.
- Use `prefetchnta` if the data is only used once or the data set fits into L1 cache. Use `prefetcht0` if the data set fits into L2 cache.

The above steps are platform-specific and provide an implementation example.



**Figure 6-5 Benefits of Incorporating Prefetch into Code**

Use Once	Multi-Use	
	Adjacent passes	Non-Adjacent passes
prefetchnta	prefetchnta, SM1	prefetcht0, SM2, L2 pollution

### Single-pass versus Multi-pass Execution

An algorithm can use single- or multi-pass execution defined as follows:

- Single-pass, or unlayered execution passes a single data element through an entire computation pipeline.
- Multi-pass, or layered execution performs a single stage of the pipeline on a batch of data elements, before passing the batch on to the next stage.

A characteristic of both single-pass and multi-pass execution is that a specific tradeoff exists depending on an algorithm's implementation and use of a single- or multiple-pass execution, see Figure 6-6.

Multi-pass execution is often easier to use when implementing a general purpose API, which has lots of different code paths that can be taken, depending on the specific combination of features selected by the application (for example, for 3D graphics, this might include the type of vertex primitives used, the number and type of light sources).

With such a broad range of permutations possible, a single-pass approach would be complicated, in terms of code size and validation. In such cases, each possible permutation would require a separate code sequence. For example, data object of type N, with features A, C, E enabled, would be one code path. It makes more sense to perform each pipeline stage as a separate pass, with conditional clauses to select different features that are implemented within each stage. By using strip-mining, the amount of vertices processed by each stage (for example, the batch size) can be selected to ensure that the batch stays within the processor caches through all passes. An intermediate cached buffer is used to pass the batch of vertices from one stage/pass to the next one.

Single-pass execution can be better suited to some applications, which limit the number of features that may be used at a given time. A single-pass approach can reduce the amount of data copying that can occur with a multi-pass engine, see Figure 6-6.

**Figure 6-6 Single-Pass vs. Multi-Pass 3D Geometry Engines**

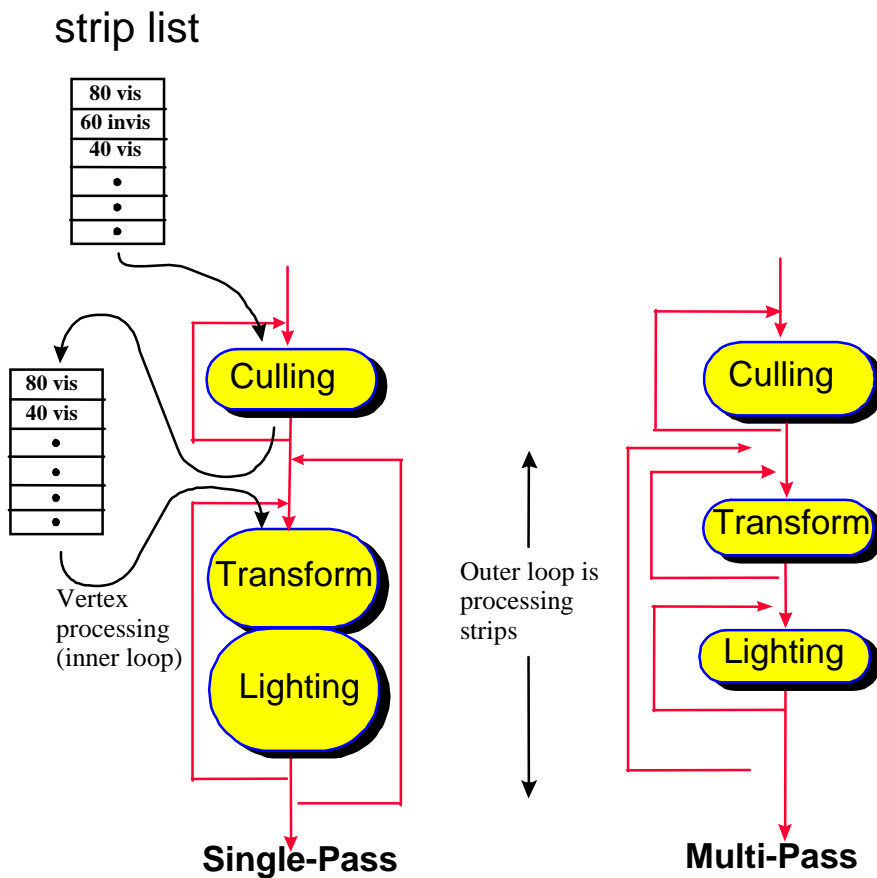

The choice of single-pass or multi-pass can have a number of performance implications. For instance, in a multi-pass pipeline, stages that are limited by bandwidth (either input or output) will reflect more of this performance limitation in overall execution time. In contrast, for a single-pass approach, bandwidth-limitations can be distributed/amortized across other computation-intensive stages. Also, the choice of which prefetch hints to use are also impacted by whether a single-pass or multi-pass approach is used (see [“Prefetch and Cacheability Instructions”](#) section earlier in this chapter).

## Memory Bank Conflicts

Memory bank conflicts occur when independent memory references go to the same DRAM bank but access different pages. Conflicting memory bank accesses will introduce longer memory leadoff latency due to DRAM page opening, closing, and opening. To alleviate such problems, arrange the memory layout of data arrays such that simultaneous prefetch of different pages will hit distinct memory banks. The operating system handles physical address allocation at run-time, so compilers/programmers have little control over this. Potential solutions are:

- Apply array grouping to group contiguously used data together to reduce excessive memory page accesses
- Allocate data within 4KB memory pages

## Non-temporal Stores and Software Write-Combining

Use non-temporal stores in the cases when the data are

- write-once (non-temporal)
- too large and thus cause cache thrashing.

Non-temporal stores do not invoke a cache line allocation, which means they are not write-allocate. As a result, caches are not polluted and no dirty writeback is generated to compete with useful data bandwidth. Without using non-temporal stores, bus bandwidth will suffer from lots of dirty writebacks after the point when caches start to be thrashed.

In the Streaming SIMD Extensions implementation, when non-temporal stores are written into writeback or write-combining memory regions, these stores are weakly-ordered, then combined internally inside the processor's write-combining buffer, and written out to memory as a line burst transaction. To achieve the best possible performance, it is recommended that data be aligned on a the cache line boundary and written consecutively in a cache line size while using non-temporal stores. If the consecutive writes are prohibitive due to programming constraints, then software write-combining (SWWC) buffers can be used to enable line burst transactions.

You can declare small SWWC buffers (a cache line for each buffer) in your application to enable explicit write-combining operations. Instead of writing to non-temporal memory space immediately, the program writes data into SWWC buffers and combines them inside these buffers. The program only writes a SWWC buffer out using non-temporal stores when the buffer is filled up, that is, a cache line (32 bytes for Pentium III processor). Although the SWWC method imposes extra explicit instructions for performing temporary writes and reads, this ensures that the transaction on the front-side bus causes line transactions rather than several partial transactions. Application performance gains considerably from implementing this technique. These SWWC buffers can be maintained in the L1 and re-used throughout the program.

## Cache Management

The streaming instructions (`prefetch` and `stores`) can be used to manage data and minimize disturbance of temporal data held within the processor's caches.

In addition, Pentium III processors take advantage of the Intel C/C++ Compiler that supports C/C++ language-level features for the Streaming SIMD Extensions. The Streaming SIMD Extensions and MMX technology instructions provide intrinsics that allow you to optimize cache utilization. The examples of such Intel compiler intrinsics are `_mm_prefetch`, `_mm_stream`, `_mm_load`, `_mm_sfence`. For more details on these intrinsics, refer to the *Intel C/C++ Compiler User's Guide for Win32 Systems*, order number 718195.

The following examples of using prefetching instructions in the operation of video encoder and decoder as well as in simple 8-byte memory copy, illustrate performance gain from using the prefetching instructions for efficient cache management.

### Video Encoder

In a video encoder example, some of the data used during the encoding process is kept in the processor's L2 cache, to minimize the number of reference streams that must be re-read from system memory. To ensure that other writes do not disturb the data in the L2 cache, streaming stores (`movntq`) are used to write around all processor caches.

The prefetching cache management implemented for video encoder reduces the memory traffic. The L2 pollution reduction is ensured by preventing single-use video frame data from entering the L2. Implementing a non-temporal prefetch (`prefetchnta`) instruction brings data directly to the L1 cache without polluting the L2 cache. If the data brought directly to L1 is not re-used, then there is a performance gain from the non-temporal prefetch over a temporal prefetch. The encoder uses non-temporal prefetches to avoid pollution of the L2 cache, increasing the number of L2 hits and decreasing the number of polluting write-backs to memory. The performance gain results from the more efficient use of the L2, not only from the prefetch itself.

### Video Decoder

In a video decoder example, completed frame data is written to `USWC`, the local memory of the graphics card. A copy of reference data is stored to the `WB` memory at a later time by the processor in order to generate future data. The assumption is that the size of the data is too large to fit in the processor's caches. A streaming store is used to write the data around the cache, to avoid displacing other temporal data held in the caches. Later, the processor re-reads the data using `prefetchnta`, which ensures maximum bandwidth, yet minimizes disturbance of other cached temporal data by using the non-temporal (NTA) version of prefetch.

## Conclusions from Video Encoder and Decoder Implementation

The example of video encoder and decoder suggests the conclusion that by using an appropriate combination of non-temporal prefetches and non-temporal stores, an application can be designed to lessen the overhead of memory transactions by preventing L2 cache pollution, keeping useful data in the L2 cache and reducing costly write-back transactions. Even if an application does not gain performance significantly from having data ready from prefetches, it can improve from more efficient use of the L2 cache and memory. Such design reduces the encoder's demand for such critical resources as the memory bus. This makes the system more balanced, resulting in higher performance.

## Using Prefetch and Streaming-store for a Simple Memory Copy

A simple memory copy is the case when 8-byte data elements are to be transferred from one memory location to another. The copy can be sped up greatly using prefetch and streaming store. Example 6-8 presents the basic algorithm of the simple memory copy.

### Example 6-8 Basic Algorithm of a Simple Memory Copy

---

```
#define N 512000
double a[N], b[N];
for (i = 0; i < N; i++) {
    b[i] = a[i];
}
```

---

This algorithm can be optimized using the Streaming SIMD Extensions and taking into consideration the following:

- proper layout of pages in memory
- cache size
- interaction of the transaction lookaside buffer (TLB) with memory accesses
- combining prefetch and streaming-store instructions.

The guidelines discussed in this chapter come into play in this simple example. TLB priming, however, is introduced here as it does affect an optimal implementation with prefetching.

### TLB Priming

The TLB is a fast memory buffer that is used to improve performance of the translation of a virtual memory address to a physical memory address by providing fast access to page table entries. If memory pages are accessed and the page table entry is not resident in the TLB, a TLB miss results and the page table must be read from memory. The TLB miss results in a performance degradation since a memory access is slower than a TLB access. The TLB can be preloaded with the page table entry for the next desired page by accessing (or touching) an address in that page. This is similar to prefetch, but instead of a data cache line the page table entry is being loaded in advance of its use. This helps to ensure that the page table entry is resident in the TLB and that the prefetch happens as requested subsequently.

### Optimizing the 8-byte Memory Copy

Example 6-9 presents the copy algorithm that performs the following steps:

1. transfers 8-byte data from memory into L1 cache using the `_mm_prefetch` intrinsic to completely fill the L1 cache, 32 bytes at a time.
2. transfers the 8-byte data to a different memory location via the `_mm_stream` intrinsics, bypassing the cache. For this operation, it is important to ensure that the page table entry prefetched for the memory is preloaded in the TLB.
3. loads the data into an `xmm` register using the `_mm_load_ps` intrinsic.
4. streaming-stores the data to the location corresponding to array `b`.

## Example 6-9 An Optimized 8-byte Memory Copy

---

```

#define CACHESIZE 4096;
for (kk=0; kk<N; kk+=CACHESIZE) {
    temp = a[kk+CACHESIZE];
    for (j=kk+4; j<kk+CACHESIZE; j+=4) {
        _mm_prefetch((char*)&a[j], _MM_HINT_NTA);
    }
    for (j=kk; j<kk+CACHESIZE; j+=4) {
        _mm_stream_ps((float*)&b[j],
            _mm_load_ps((float*)&a[j]));

        _mm_stream_ps((float*)&b[j+2],
            _mm_load_ps((float*)&a[j+2]));
    }
}
_mm_sfence();

```

---

In Example 6-9, two `_mm_load_ps` and `_mm_stream_ps` intrinsics are used so that all of the data prefetched (a 32-byte cache line) is written back. The prefetch and streaming-stores are executed in separate loops to minimize the number of transitions between reading and writing data. This significantly improves the bandwidth of the memory accesses.

The instruction, `temp = a[kk+CACHESIZE]`, is used to ensure the page table entry for array `a` is entered in the TLB prior to prefetching. This is essentially a prefetch itself, as a cache line is filled from that memory location with this instruction. Hence, the prefetching starts from `kk+4` in this loop.



# *Application Performance Tools*

---

## 7

Intel offers an array of application performance tools that are optimized to take the best advantage of the Intel® architecture (IA)-based processors. This chapter introduces these tools and explains their capabilities which you can employ for developing the most efficient programs.

The following performance tools are available:

- **VTune™ Performance Analyzer**  
This tool is the cornerstone of the application performance tools that make up the VTune Performance Enhancement Environment CD. The VTune analyzer collects, analyzes, and provides Intel architecture-specific software performance data from the system-wide view down to a specific module, function, and instruction in your code.
- **Intel C/C++ Compiler and Intel Fortran Compiler plug-ins.**  
Both compilers are available as plug-ins to the Microsoft Developer Studio\* IDE. The compilers generate highly optimized floating-point code, and provide unique features such as profile-guided optimizations and MMX™ technology intrinsics.
- **Intel® Performance Library Suite**  
The library suite consists of a set of software libraries optimized for Intel architecture processors. The suite currently includes:
  - The Intel Signal Processing Library (SPL)
  - The Intel Recognition Primitives Library (RPL)
  - The Intel Image processing Library (IPL)
  - The Intel Math Kernel Library (MKL)
  - The Intel Image Processing Primitives (IPP)
  - The Intel JPEG library (IJP)

- The Register Viewing Tool (RVT) for Windows\* 95 and Windows NT\* enables you to view the contents of the Streaming single-instruction, multiple-data (SIMD) Extensions registers. The RVT replaces the register window normally found in a debugger.  
The RVT also provides disassembly information during debug for Streaming SIMD Extensions.

## VTune™ Performance Analyzer

VTune Performance Analyzer is instrumental in helping you understand where to begin tuning your application. VTune analyzer helps you identify and analyze performance trends at all levels: the system, micro-architecture, and application.

The sections that follow discuss the major features of the VTune analyzer that help you improve performance and briefly explain how to use them. For more details on how to sample events, run VTune analyzer and see online help.

### Using Sampling Analysis for Optimization

The sampling feature of the VTune analyzer provides analysis of the performance of your applications using time- or event-based sampling and hotspot analysis. The time- or event-based sampling analysis provides the capability to non-intrusively monitor all active software on the system, including the application.

Each sampling session contains summary information about the session, such as the number of samples collected at each privilege level and the type of interrupt used. Each session is associated with a database. The session database allows you to reproduce the results of a session any number of times without having to sample or profile.

#### Time-based Sampling

Time-based sampling (TBS) allows you to monitor all active software on your system, including the operating system, device drivers, and application software. TBS collects information at a regular time interval. The VTune analyzer then processes this data to provide a detailed view of the system's activity.

The time-based sampling (TBS) periodically interrupts the processor at the specified sampling interval and collects samples of the instruction addresses, matches these addresses with an application or an operating system routine, and creates a database with the resulting samples data. VTune analyzer can then graphically display the amount of CPU time spent in each active module, process, and processor (on a multiprocessor system). The TBS—

- samples and display a system-wide view of the CPU time distribution of all the software activity during the sampling session
- determines which sections in your code are taking the most CPU time
- analyzes hotspots, displays the source code, and determines performance issues at the source and assembly code levels.

Figure 7-1 provides an example of a hotspots report by location.

**Figure 7-1** Sampling Analysis of Hotspots by Location

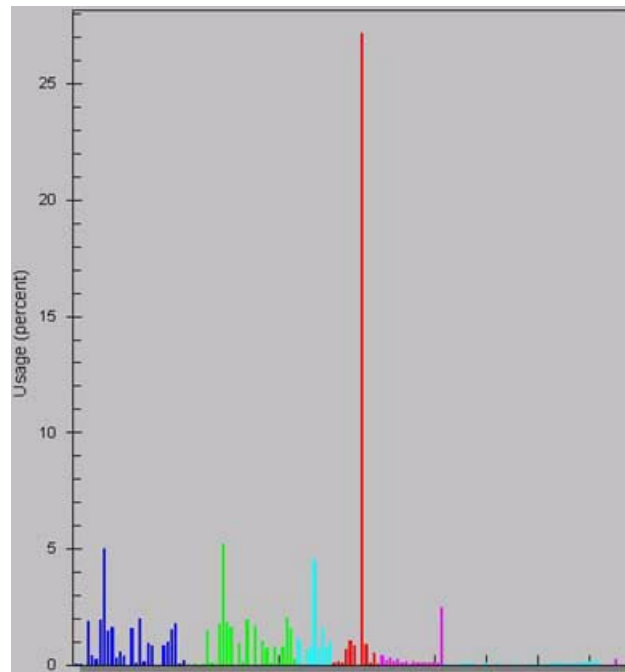

## Event-based Sampling

You can use event-based sampling (EBS) to monitor all active software on your system, including the operating system, device drivers, and application software based on the occurrence of processor events.

The VTune analyzer collects, analyzes, and displays the performance event counters data of your code provided by the Pentium® II and Pentium III processors. These processors can generate numerous events per clock cycle. The VTune analyzer supports the events associated with counter 0 only.

For event-based sampling, you can select one or more events, in each event group. However, the VTune analyzer runs a separate session to monitor each event you have selected. It interrupts the processor after a specified number of events and collects a sample containing the current instruction address. The frequency at which the samples are collected is determined by how often the event is caused by the software running in the system during the sampling session.

The data collected allows you to determine the number of events that occurred and the impact they had on performance. Sampling results are displayed in the Modules report and Hotspots report. Event data is also available as a performance counter in the Chronologies window. The event sampled per session is listed under the Chronologies entry in the Navigation tree of the VTune analyzer.

## Sampling Performance Counter Events

Event-based sampling can be used together with the hardware performance counters available in the Intel architecture to provide detailed information on the behavior of specific events in the microprocessor. Some of the microprocessor events that can be sampled include L2 cache misses, branch mispredictions, misaligned data access, processor stalls, and instructions executed.

VTune analyzer provides access to the performance counters listed in Appendix B, “[Performance-Monitoring Events and Counters](#).” The processors' performance counters can be configured to monitor any of several different types of events. All the events are listed in the Configure menu/Options command/Processor Events for EBS page of the VTune analyzer, see Figure 7-2.

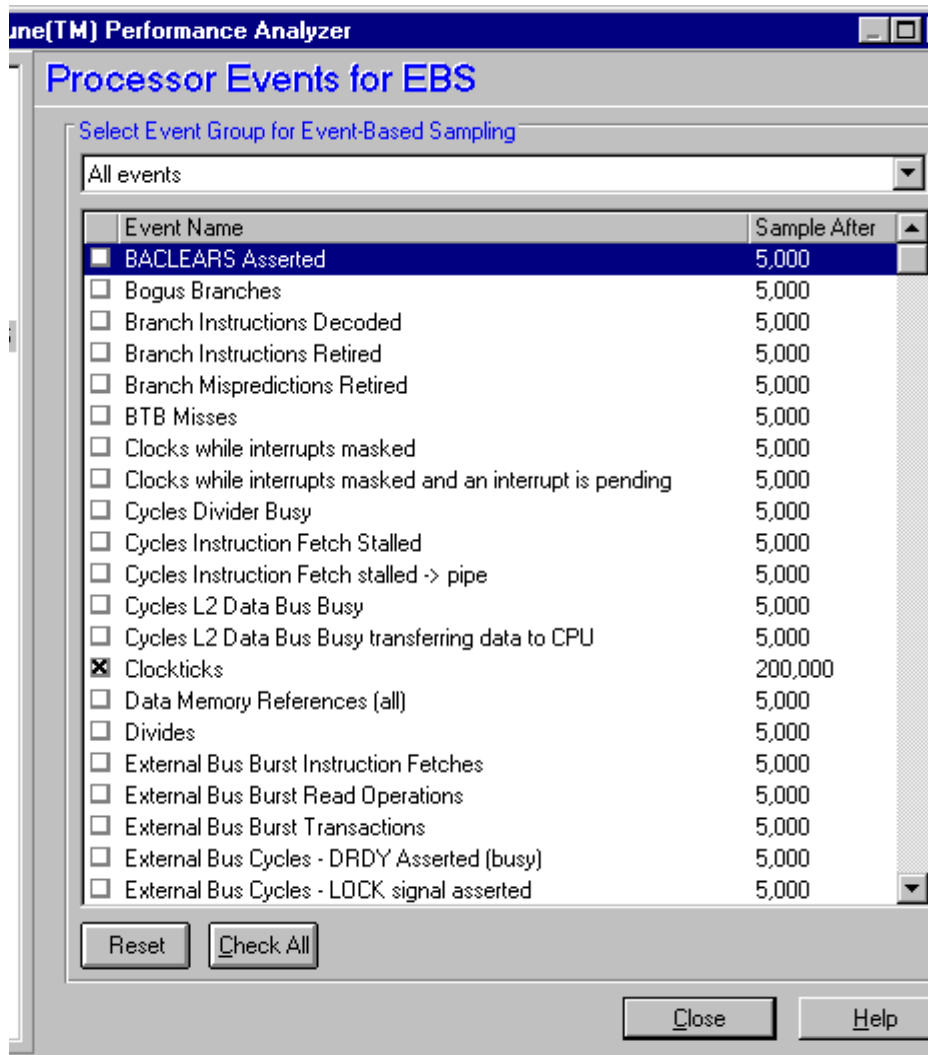
**Figure 7-2 Processor Events List**

At first glance, it is difficult to know which counters are relevant for understanding the performance effects. For example, to better understand performance effects on the cache and bus behavior with the Pentium III

processor, the VTune analyzer collected the performance data with and without the prefetch and streaming store instructions. The main counters that relate to the activity of the system bus, as well as the cache hierarchy include:

- **L1 cache misses**—this event indicates the number of outstanding L1 cache misses at any particular time.
- **L2 cache misses**—this event indicates all data memory traffic that misses the L2 cache. This includes loads, stores, locked reads, and ItoM requests.
- **L2 cache requests**—this event indicates all L2 cache data memory traffic. This includes loads, stores, locked reads, and ItoM requests.
- **Data memory references**—this event indicates all data memory references to the L1 data and instruction caches and to the L2 cache, including all loads from and to any memory types.
- **External bus memory transactions**—this event indicates all memory transactions.
- **External bus cycles processor busy receiving data**—VTune analyzer counts the number of bus clock cycles during which the processor is busy receiving data.
- **External bus cycles DRDY asserted**—this event indicates the number of clocks during which DRDY is asserted. This, essentially, indicates the utilization of the data bus.

Other counters of interest are:

- **Instructions retired**—this event indicates the number of instructions that retired or executed completely. This does not include partially processed instructions executed due to branch mispredictions.
- **Floating point operations retired**—this event indicates the number of floating point computational operations that have retired.
- **Clockticks**—this event initiates time-based sampling by setting the counters to count the processor's clock ticks.
- **Resource-related stalls**—this event counts the number of clock cycles executed while a resource-related stall occurs. This includes stalls due to register renaming buffer entries, memory buffer entries, branch misprediction recovery, and delay in retiring mispredicted branches.
- **Prefetch NTA**—this event counts the number of Streaming SIMD Extensions `prefetchnta` instructions.

The raw data collected by the VTune analyzer can be used to compute various indicators. For example, ratios of the clockticks, instructions retired, and floating-point instructions retired can give you a good indication as to which parts of applications are best suited for a potential re-coding with the Streaming SIMD Extensions.

## Call Graph Profiling

The call graph profiles your applications and displays a call graph of active functions. The call graph analyzes the data and displays a graphical view of the threads created during the execution of the application, a complete list of the functions called, and the relationship between the parent and child functions. Use VTune analyzer to profile your Win32\* executable files or Java\* applications and generate a call graph of active functions.

Call graph profiling includes collecting and analyzing call-site information and displaying the results in the Call List of the Call Graph and Source views. The call graph profiling provides information on how many times a function (caller) called some other function (callee) and the amount of time each call took. In many cases the caller may call the callee from several places (sites), so call graph also provides call information per site. (Call site information is not collected for Java call graphs.)

The View by Call Sites displays the information about callers and callees of the function in question (also referred to as current function) by call sites. This view allows you to locate the most expensive calls.

## Call Graph Window

The call graph window comprises three views: Spreadsheet, Call Graph, and Call List, see Figure 7-3. The Call Graph view, displayed on the lower section of the window, corresponds to the function (method) selected in the Spreadsheet. It displays the function, the function's parents, and function's child functions.

**Figure 7-3 Call Graph Window**

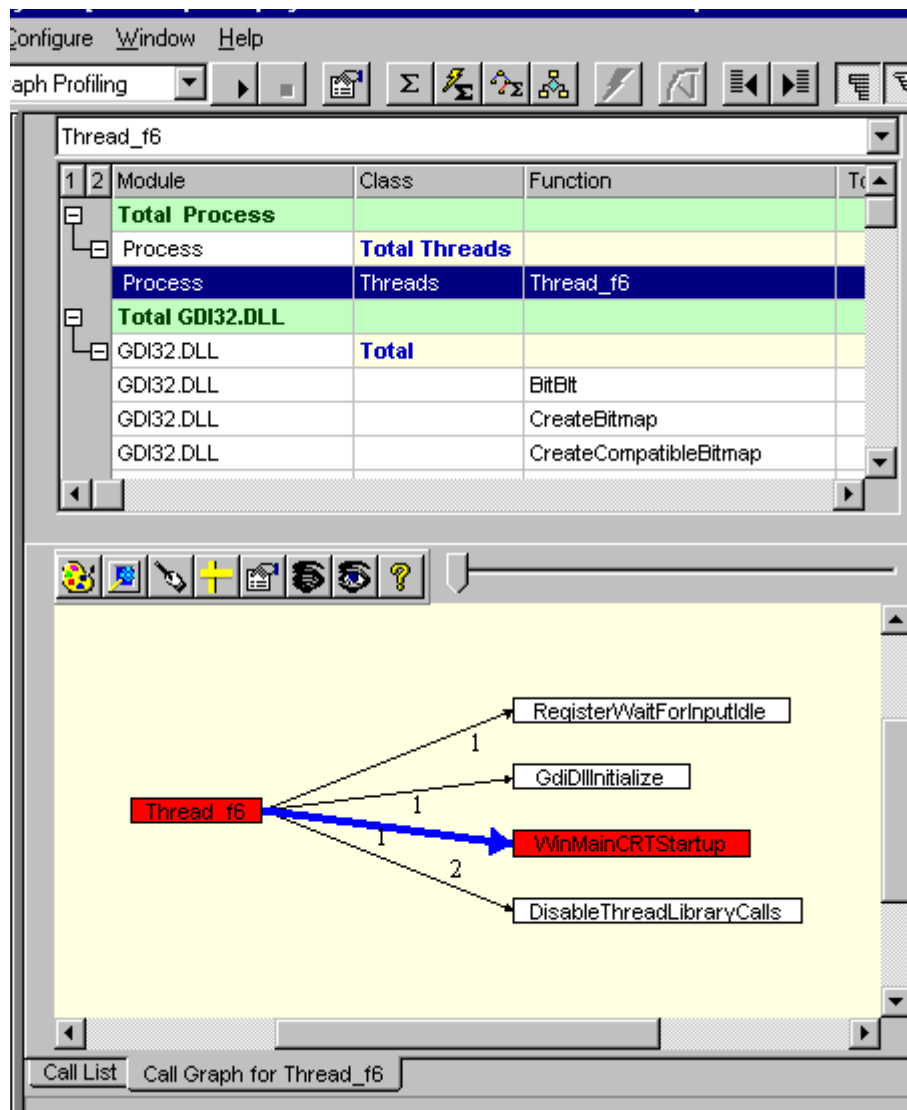



Each node (box) in the call graph represents a function. Each edge (line with an arrow) connecting two nodes represents the call from the parent (caller) to the child function (callee). The number next to the edge (line) indicates the number of calls to that function.

The window has a Call List tab in the bottom of the Call Graph view. The Call List view lists all the callers and the callees of the function selected in the spreadsheet and displayed in the Call Graph view. In addition, the Call List has a View by Call Sites in which you can see call information represented by call sites.

## Static Code Analysis

This feature analyzes performance through

- performing static code analysis of the functions or blocks of code in your application without executing your application
- getting a list of functions with their respective addresses for quick access to your code
- getting summary information about the percentage of pairing and penalties incurred by the instructions in each function.

The static code analyzer provides analysis of the instructions in your application and their relationship with each other, without executing or sampling them. It provides an estimation of the performance of your application, not actual performance. The static code analyzer analyzes the module you specified in the Executable field and displays the results. By default, the static code analyzer analyzes only those functions in the module that have source code available.

During the static code analysis, the static code analyzer does the following tasks:

- searches your program for the debug symbols or prompts you to specify the symbol files
- searches the source directories for the source files
- analyzes each basic block and function in your program
- creates a database with the results

- displays summary information about the performance of each function, including its name, address, the number of instructions executed, the percentage of pairing, the total clock cycles incurred, and the number of clock cycles incurred due to penalties.

### Static Assembly Analysis

This feature of the VTune analyzer determines performance issues at the processor level, including the following:

- how many clocks each instruction takes to execute and how many of them were incurred due to penalties
- how your code is executing in the three decode units of the Pentium II and Pentium III processors
- regardless of the processor your system is using, the static assembly analyzer analyzes your application's performance as it would run on Intel processors, from Intel486™ to Pentium III processors.

The VTune analyzer's static assembly analyzer analyzes basic blocks of code. It assumes that the code and data are already in the cache and ignores loops and jumps. It disassembles your code and displays assembly instructions, annotated with performance information.

The static assembly analyzer disassembles hotspots or static functions in your Windows 95, 98 and NT binary files and analyzes architectural issues that effect their performance. You can invoke Static Assembly Analysis view either by performing a static code analysis or by time or event-based sampling of your binary file. Click on the View Static Assembly Analysis icon in the VTune analyzer's toolbar to view a static analysis of your code and display the assembly view.

### Dynamic Assembly Analysis

Dynamic assembly analysis fine-tunes sections of your code and identifies the exact instructions that cause critical performance problems. It simulates a block of code and discovers such events as missed cache accesses, renaming stalls, branch target buffer (BTB) misses, and misaligned data that can degrade performance on Intel architecture-based processors.

Dynamic analysis gives you precise data about the behavior of the cache and BTB by simulating the inner-workings of Intel's super-scalar, out-of-order micro-architecture. The dynamic assembly analyzer executes

the application, traces its execution, simulates, and monitors the performance of the code you specify. You can perform dynamic analysis using three different simulation methods:

- Selected code
- Uniform sampling
- Start and stop API

These methods provide alternate ways of filtering data and focusing on critical sections of code. They differ in the way they invoke dynamic analysis, simulate and analyze specific instructions, and in the amount of output they display. For example, in the selected code method, the dynamic assembly analyzer analyzes and displays output for every instruction within a selected range, while in the uniform sampling and start/stop API simulation methods, only the critical sections of code are simulated and analyzed.

### Code Coach Optimizations

The code coach performs the following:

- Analyzes C, FORTRAN, C++, and Java\* source code and produces high-level source code optimization advice.
- Analyzes assembly code or disassembled assembly code and produces assembly instruction optimization advice.

Once the VTune analyzer identifies, analyzes, and displays the source code for hotspots or static functions in your application, you can invoke the coach for advice on how to rewrite the code to optimize its performance.

Typically, a compiler is restricted by language pointer semantics when optimizing code. Coach suggests source-level modifications to overcome these and other restrictions. It recognizes commonly used code patterns in your application and suggests how they can be modified to improve performance. The coach window is shown in Figure 7-4.

You can invoke the coach from the Source View window by double-clicking on a line of code, or selecting a block of code and then clicking on the code coach icon on the Source View toolbar.

Figure 7-4 Code Coach Optimization Advice

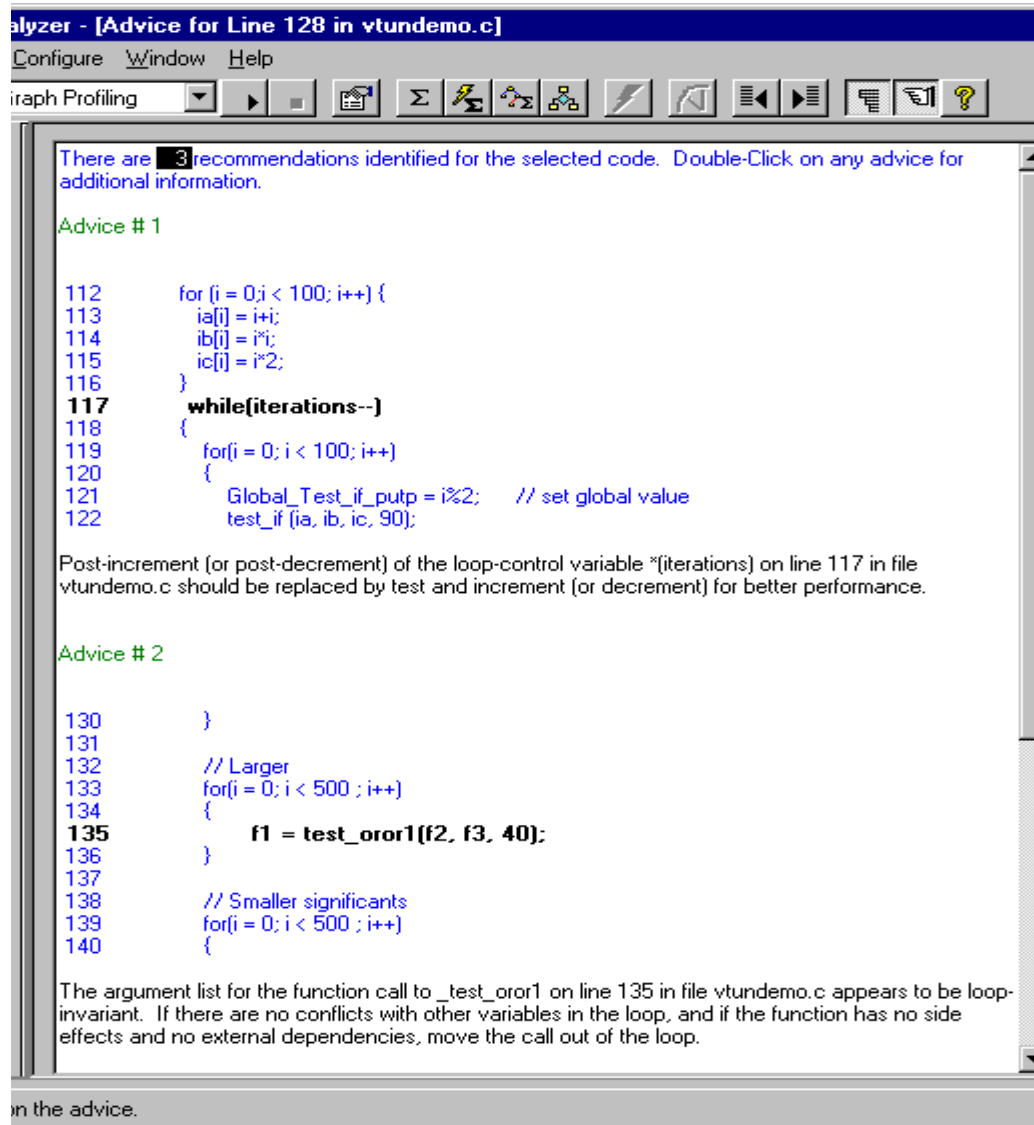

The coach examines the entire block of code or function you selected and searches for optimization opportunities in the code. As it analyzes your code, it issues error and warning messages much like a compiler parser. Once the coach completes analyzing your code, if it finds suitable optimization advice, it displays the advice in a separate window.

The coach may have more than one advice for a loop or function. If no advice is available, it displays an appropriate message. You can double-click on any advice in the coach window to display context-sensitive help with examples of the original and optimized code.

Where performance can be improved using MMX technology or Streaming SIMD Extensions intrinsics, the coach provides advice in the form of C-style pseudocode, leaving the data definitions, loop control, and subscripts to the programmer.

For the code using the intrinsics, you can double-click the left mouse button on an argument used in the code to display the description of that argument. Click your right mouse button on an intrinsic to invoke a brief description of that intrinsic.

### **Assembly Coach Optimization Techniques**

Assembly coach uses many optimization techniques to produce its recommended optimized code, for example:

- **Instruction Selection**—assembly coach analyzes each instruction in your code and suggests alternate, equivalent replacements that are faster or more efficient.
- **Instruction Scheduling**—assembly coach uses its in-depth knowledge of processor behavior to suggest an optimal instruction sequence that preserves your code's semantics.
- **Peephole Optimization**—assembly coach identifies particular instruction sequences in your code and replaces them with a single, equivalent instruction.
- **Partial Register Stall Elimination**—assembly coach identifies instruction sequences that can produce partial register stalls and replaces them with alternative sequences that do not cause partial stalls.

In Automatic Optimization and Single Step Optimization modes, you can select or deselect these optimization types in the Assembly Coach Options tab.

## Intel Compiler Plug-in

The Intel C/C++ compiler is compatible with Microsoft Visual C++\* and is available as a plug-in to the Microsoft Developer Studio IDE.

Intel C/C++ compiler allows you to optimize your code by using special optimization command-line options described in this section.

The optimization command-line options generally are `-O1` and `-O2`. Each of them enables a number of specific optimization options. In most cases, `-O2` is recommended over `-O1` because the `-O2` option enables inline expansion, which helps programs that have many function calls. The `O2` option is on by default.

The `-O1` and `-O2` options enable the options as follows:

- |                  |   |
|------------------|---|
| <code>-O1</code> | Enables options <code>-Og</code> , <code>-Oi-</code> , <code>-Os</code> , <code>-Oy</code> , <code>-Ob1</code> , <code>-Gf</code> , <code>-Gs</code> , and <code>-Gy</code> . However, <code>-O1</code> disables a few options that increase code size. |
| <code>-O2</code> | Enables options <code>-Og</code> , <code>-Oi</code> , <code>-Ot</code> , <code>-Oy</code> , <code>-Ob1</code> , <code>-Gf</code> , <code>-Gs</code> , and <code>-Gy</code> . Confines optimizations to the procedural level.                            |

All the command-line options are described in the *Intel C/C++ Compiler User's Guide for Win32 Systems*, order number 718195.

The `-Od` option disables optimization. You can specify optimization option as “any” instead of `-O1` or `-O2`. This is the only optimization not disabled by `-Od`.

## Code Optimization Options

This section describes the options used to optimize your code and improve the performance of your application.

### Targeting a Processor (-Gn)

Use `-Gn` to target an application to run on a specific processor for maximum performance. Any of the `-Gn` suboptions you choose results in your binary running on a corresponding Intel architecture 32-bit processors. `-G6` is the default, and targets optimization for the Pentium II and Pentium III processors.

### Automatic Processor Dispatch Support (-Qx[extensions] and -Qax[extensions])

The `-Qx[extensions]` and `-Qax[extensions]` options provide support to generate code that is specific to processor-instruction extensions.

`-Qx[extensions]` generates specialized code to run exclusively on the processors indicated by the extension.

`-Qax[extensions]` generates code specialized to the specified extensions, but also generates generic IA-32 code. The generic code is usually slower. A runtime check for the processor type is made to determine which code executes.

You can specify the same extensions for either option as follows:

- `i` Pentium II and Pentium III processors, which use the `CMOV` and `FCMOV` instructions
- `M` Pentium II and Pentium III processors
- `K` Streaming SIMD Extensions, which include the `i` and `M` extensions.



---

**CAUTION.** When you use `-Qax[extensions]` in conjunction with `-Qx[extensions]`, the extensions specified by `-Qx[extensions]` can be used unconditionally by the compiler, and the resulting program will require the processor extensions to execute properly.

---

## Vectorizer Switch Options

The Intel C/C++ Compiler can vectorize your code using the vectorizer switch options. The option that enables the vectorizer is `-Qvec`. The compiler provides a number of other vectorizer switch options that allow you to control vectorizations. All vectorization switches require the `-Qvec` switch to be on. The default is off.

The vectorizer switch options can be activated from the command line. In addition to the `-Qvec` switch, the compiler provides the following vectorization control switch options:

<code>-Qvec_alignment</code>	Controls the default alignment of vectorizable data.
<code>-Qvec_verbose</code>	Controls the vectorizer's diagnostic levels.
<code>-Qrestrict</code>	Enables pointer disambiguation with the <code>restrict</code> qualifier.
<code>-Qkscalar</code>	Performs all 32-bit floating point arithmetic using the Streaming SIMD Extensions instead of the default x87 instructions.
<code>-Qvec_emms[-]</code>	Controls the automation of EMMS instruction insertions to empty the MMX instruction registers.
<code>-Qvec_no_arg_alias[-]</code>	Assumes on entry that procedure arguments are not aliased.
<code>-Qvec_no_alias[-]</code>	Assumes that no aliasing can occur between objects with different names.

## Prefetching (`-Qpf [options]`)

Use `-Qpf` to automatically insert prefetching on a Pentium III processor. This option enables three suboptions (`-Qpf_loop`, `-Qpf_call`, and `-Qpf_sstore`) each of which improves cache behavior. The following example invokes `-Qpf` as one option with all its functionality:

```
prompt> icl -Qpf prog.cpp
```



### Loop Unrolling (-Qunrolln)

Use `-Qunrolln` to specify the maximum number of times you want to unroll a loop. For example, to unroll a loop at most four times, use this command:

```
prompt> icl -Qunroll4 a.cpp
```

To disable loop unrolling, specify `n` as 0.

### Inline Expansion of Library Functions (-Oi, -Oi-)

The compiler inlines a number of standard C, C++, and math library functions by default. This usually results in faster execution of your program. Sometimes, however, inline expansion of library functions can cause unexpected results. For explanation, see *Intel C/C++ Compiler User's Guide for Win32 Systems*, order number 718195.

### Floating-point Arithmetic Precision (-Op, -Op-, -Qprec, -Qprec\_div, -Qpc, -Qlong\_double)

These options provide optimizations with varying degrees of precision in floating-point arithmetic.

### Rounding Control Option (-Qrcd)

The compiler uses the `-Qrcd` option to improve the performance of code that requires floating point calculations. The optimization is obtained by controlling the change of the rounding mode.

The `-Qrcd` option disables the change to truncation of the rounding mode in floating point-to-integer conversions.

For complete details on all of the code optimization options, refer to the *Intel C/C++ Compiler User's Guide for Win32 Systems*, order number 718195.

## Interprocedural and Profile-Guided Optimizations

The following are two methods to improve the performance of your code based on its unique profile and procedural dependencies:

**Interprocedural Optimization (IPO)**—Use the `-Qip` option to analyze your code and apply optimizations between procedures within each source file. Use multifile IPO with `-Qipo` to enable the optimizations between procedures in separate source files.

Use the `-Qoption` suboption with the applicable keywords to select particular in-line expansions and loop optimizations. If you specify `-Qip` without the `-Qoption` qualification, the compiler expands functions in line, propagates constant arguments, passes arguments in registers, and monitors module-level static variables.

**Profile-Guided Optimization (PGO)**—Creates an instrumented program from your source code and special code from the compiler. Each time this instrumented code is executed, the compiler generates a dynamic information file. When you compile a second time, the dynamic information files are merged into a summary file. Using the profile information in this file, the compiler attempts to optimize the execution of the most heavily travelled paths in the program.

When you use PGO, consider the following guidelines:

- Minimize the changes to your program after instrumented execution and before feedback compilation. During feedback compilation, the compiler ignores dynamic information for functions modified after that information was generated.



---

**NOTE.** *The compiler issues a warning that the dynamic information corresponds to a modified function.*

---

- Repeat the instrumentation compilation if you make many changes to your source files after execution and before feedback compilation.

For complete details on the interprocedural and profile-guided optimizations, refer to the *Intel C/C++ Compiler User's Guide for Win32 Systems*, order number 718195.

## Intel Performance Library Suite

The Intel Performance Library Suite (PLS) includes the following libraries:

- The Intel Signal Processing Library: set of signal processing functions similar to those available for most Digital Signal Processors (DSPs)
- The Intel Recognition Primitives Library, a set of 32-bit recognition primitives for developers of speech- and character-recognition software

- The Intel Image Processing Library, a set of low-level image manipulation functions particularly effective at taking advantage of MMX technology
- The Intel Math Kernel Library, a set of linear algebra and fast Fourier transform functions for developers of scientific programs.
- The Intel Image Processing Primitives: a collection of low-overhead versions of common functions on 2D arrays intended as a supplement or alternative to the Intel Image Processing Library.

## Benefits Summary

The overall benefits the libraries provide to the application developers are as follows:

- Low-level functions for multimedia applications
- Highly-optimized routines with a C interface, “no assembly required”
- Processor-specific optimization
- Processor detection and DLL dispatching
- Pure C version for any IA processor
- Custom DLL builder for reduced memory footprint
- Built-in error handling facility

The libraries are optimized for all Intel architecture-based processors. The custom DLL builder allows your application to include only the functions required by the application.

## Libraries Architecture

Each library in the Intel Performance Library Suite implements specific architecture that ensures high performance. The Signal Processing Library (SPL), the Recognition Primitives Library (RPL), and the Math Kernel Library (MKL) use the data types such as signed and unsigned short integers, output scale or saturation mode, and single and double-precision floats. The bulk of the functions support real and complex functions. All these features ensure fast internal computations at higher precision.

The Image Processing Library (IPL) implements specific image processing techniques such as bit depths, multiple channels, data alignment, color conversion, region of interest and tiling. The region of interest (ROI) defines

a particular area within entire image and enables you to perform operations on it. Tiling is a technique that handles large images by dividing an image into sub-blocks.

The Image Processing Primitives (IPP) library is a collection of high-performance operations performed on 1D and 2D arrays of pixels. The IPP provides lower-overhead versions of common functions on 2D arrays and is intended as a supplement or alternative to the Intel Image Processing Library.

The Math Kernel Library (MKL) is most helpful for scientific and engineering applications. Its high-performance math functions include Basic Linear Algebra Subprograms (BLAS) and fast Fourier transforms (FFTs) that run on multiprocessor systems. No change of the code is required for multiprocessor support. The library is threadsafe and shows the best results when compiled by the Intel compiler.

All libraries employ complicated memory management schemes and processor detection.

## Optimizations with Performance Library Suite

The PLS implements a number of optimizations discussed throughout this manual, including architecture-specific tuning such as loop unrolling, instructions pairing and instructions scheduling; memory managing such as prefetching and cache tuning.

The library suite focuses on taking advantage of the parallelism of the SIMD instructions that comprise the MMX technology and Streaming SIMD Extensions. This technique improves the performance of computationally intensive image processing functions. Thus the PLS includes a set of functions whose performance significantly improves when used with the Intel architecture processors. In addition, the libraries use table look-up techniques and fast Fourier transforms (FFTs).

The PLS frees the application developers from assembly programming for the variety of frequently used functions and prepares the programs for the new processor since the libraries are capable of detecting the processor type, including the future processors, and adjusting the code accordingly.

---

## Register Viewing Tool (RVT)

The Register Viewing Tool (RVT) for Windows 95, 98, and Windows NT allows you to directly view the contents of the Streaming SIMD Extensions registers without using a debugger. In addition, the RVT provides disassembly information during debug for Streaming SIMD Extensions. This capability of viewing the contents of registers without using debugger is the contribution of the RVT to optimizing your application. For complete details, refer to the *Register Viewing Tool*, version 4.0 online help.

### Register Data

The RVT displays the contents of the Streaming SIMD Extensions registers in an RVT Display window. The contents of the eight Streaming SIMD Extensions registers, XMM0 through XMM7 fields are displayed in one of four formats: byte (16 bytes), word (8 words), dword (4 doublewords) or single (4 single words in floating-point format). The RVT allows you to set the format as you need. The new value appears in red.

The window displays the trapped code segment register and the trapped extended instruction pointer. The window has a First Byte Field which allows you to enter the first byte value of the break-point command when a break point is reached. From the RVT display window, you can call the Disassembly window.

### Disassembly Data

In a debug mode, the disassembly window displays the full disassembly of the current EIP address plus 40 bytes of disassembly information before and after the current EIP. This information is shown after every debug breakpoint or single-step depending on how you set your debug environment, see Figure 7-5.

Figure 7-5 The RVT: Registers and Disassembly Window

The screenshot displays the Intel Register Viewing Tool (RVT) interface. At the top, the title bar reads "Intel Register Viewing Tool - Driver: 2.07 - Build: Nov 30 1998". Below the title bar, the current state is shown: CS: 001b, EIP: 00401211. There are buttons for "Options", "Write", and "Refresh".

The main area shows the values of XMM registers XMM0 through XMM7. XMM1 is highlighted in red, indicating it is the current register being viewed. The values for XMM0 through XMM7 are:

Register	Value 1	Value 2	Value 3	Value 4
XMM0	+6.00000e-002	+4.00000e-002	+2.00000e-002	+0.00000e+000
XMM1	+1.40000e-001	+1.20000e-001	+1.00000e-001	+8.00000e-002
XMM2	+2.50000e-001	+2.50000e-001	+2.50000e-001	+2.50000e-001
XMM3	+0.00000e+000	+0.00000e+000	+0.00000e+000	+0.00000e+000
XMM4	+0.00000e+000	+0.00000e+000	+0.00000e+000	+0.00000e+000
XMM5	+0.00000e+000	+0.00000e+000	+0.00000e+000	+0.00000e+000
XMM6	+0.00000e+000	+0.00000e+000	+0.00000e+000	+0.00000e+000
XMM7	+0.00000e+000	+0.00000e+000	+0.00000e+000	+0.00000e+000

Below the register values is a "Msg" field, which is currently empty.

The "Disassembly Window" shows the following instructions:

Address	Instruction	Operands
000401203:	movaps	xmm0, XMMWORD PTR [eax+0607]
00040120a:	movaps	xmm1, XMMWORD PTR [eax+0607]
* 000401211:	mulps	xmm0, xmm2
000401214:	mulps	xmm1, xmm2
000401217:	addps	xmm0, XMMWORD PTR [eax+07fb]

To ensure accurate disassembly information at a breakpoint, you need to enter the correct first byte value of the break-point command from the RVT display window. The RVT uses information from memory which remembers the value that you enter within a loop from one iteration to the next, up to 20 LRU first bytes. Synchronization of the RVT and the instructions occurs at the current EIP.





# *Optimization of Some Key Algorithms for the Pentium<sup>®</sup> III Processors*

---



The MMX<sup>™</sup> technology and Streaming SIMD Extensions for the Intel<sup>®</sup> architecture (IA) instruction set provides single-instruction, multiple-data (SIMD) floating-point instructions and SIMD integer instructions. These instructions, in their turn, provide a means to accelerate operations typical of 3D graphics, real-time physics, spatial (3D) audio, and others.

This appendix describes several key algorithms and their optimization for the Pentium<sup>®</sup> III processors. The algorithms discussed are:

- Using Newton-Raphson Method with the reciprocal (`rcpps`) and reciprocal square root (`rsqrtps`) instructions.
- Using `prefetch` instruction for transformation and lighting operations to reduce memory load latencies.
- Using the packed sum of absolute differences instruction (`psadbw`) to implement a fast motion-estimation error function.
- Using MMX technology and Streaming SIMD Extensions intrinsics and vector classes for any sequential sample stream either to increase or reduce the number of samples.
- Using Streaming SIMD Extensions technology intrinsics and vector classes for both real and complex 16-tap finite duration impulse response (FIR) filter.

## Newton-Raphson Method with the Reciprocal Instructions

The Newton-Raphson formula for finding the root of an equation is

$$:x_{i+1} = x_i - \frac{f(x_i)}{f'(x_i)}$$

where

- $x_i$  is the estimated root
- $f(x_i)$  is the function evaluated at the root estimate
- $f'(x_i)$  is the first derivative of the function evaluated at the root estimate.

The Newton-Raphson method is the preferred method for finding the root of functions for which the derivative can be easily evaluated and for which the derivative is continuous and non-zero in the neighborhood of the root. The Newton-Raphson method approximately doubles the number of significant digits for each iteration if the initial guess is close to the root.

The Newton-Raphson method is used to increase the accuracy of the results for the reciprocal (`rcpps`) and the reciprocal square root (`rsqrtps`) instructions. The `rcpps` and `rsqrtps` instructions return a result, which is accurate in the 12 most significant bits of the mantissa. These two instructions have a 3-cycle latency opposed to 26 cycles required to use the divide instruction.

In some algorithms, it may be desirable to have full accuracy while realizing the performance benefit of using the approximation instructions. The method illustrated in the examples yields near full accuracy, and provides a sizable performance gain compared to using the divide or square root functions. One iteration of the Newton-Raphson method is sufficient to produce a result which is accurate to 23 of 24 bits for single precision numbers (24 bits includes the implied “1” before the binary point).

For complete details, see the *Increasing the Accuracy of the Results from the Reciprocal and Reciprocal Square Root Instructions using the Newton-Raphson Method*, Intel application note, order number 243637.

## Performance Improvements

For the ASM versions, the approximation instruction (`rcpps`) and the reciprocal square root instruction (`rsqrtps`) by themselves are 1.8 and 1.6 times, respectively, faster than implementing the Newton-Raphson method. It is important to investigate whether the extra accuracy is required before using the Newton-Raphson method to insure that the maximum performance is obtained. If full accuracy is required, then the Newton-Raphson method provides a 12 times increase for the reciprocal approximation and 35 times for the reciprocal square root approximation over C code, and over a 3.3 times and 9.6 times increase above the SIMD divide instruction, respectively for each operation.

Unrolling the loops further enhances performance. After unrolling, the code was scheduled to hide the latency of the multiplies by interleaving any non-dependent operations. The gain in performance for unrolling the reciprocal code was due to reduced instructions (55%) and scheduling (45%). The gain in performance for unrolling the reciprocal square root code was due to reduced instructions (30%) and scheduling (70%).

## Newton-Raphson Method for Reciprocal Square Root

Example A-1 demonstrates a Newton-Raphson approximation for reciprocal square root operation implemented with inlined assembly for the Streaming SIMD Extensions, the intrinsics, and the `F32vec4` class. The complete sample program, including the code for the accurate Newton-Raphson Methods can be found in the `VTuneEnv\Samples\NRReciprocal` directory of the VTune Performance Enhancement Environment CD, version 4.0.

### Example A-1 Newton-Raphson Method for Reciprocal Square Root Approximation

---

```
void RecipSqRootApproximationASM(float * lpfInput, float *
lpfRecipOutput, int iNumToDo)
{
    __asm
    {
        mov esi, lpfInput
        mov edi, lpfRecipOutput
        mov ecx, iNumToDo
        shr ecx, 2                ; divide by 4, do 4 at a time
        Invert:
        movaps xmm0, [esi]
        add edi, 16
        rsqrtps xmm1, xmm0
        add esi, 16
        movaps [-16][edi], xmm1
        dec ecx
        jnz Invert
    }
}

void RecipSqRootApproximationIntrinsics(float * lpfInput, float *
lpfRecipOutput, int iNumToDo)
{
    int i;
    __m128 *In, *Out;
    In = (__m128 *) lpfInput;
    Out = (__m128 *) lpfRecipOutput;
    iNumToDo /= 4;                ; divide # to do by 4 since we are
                                ; doing 4 with each intrinsic

    for(i = 0; i < iNumToDo; i++)
    {
        *Out++ = _mm_rsqrtps(*In++);
    }
}
```

---

continued

### Example A-1 Newton-Raphson Method for Reciprocal Square Root Approximation (continued)

---

```
void RecipSqRootApproximationF32vec4(float * lpfInput, float *
lpfRecipOutput, int iNumToDo)
{
    int i;
    F32vec4 *In, *Out;

    In = (F32vec4 *) lpfInput;
    Out = (F32vec4 *) lpfRecipOutput;

    for(i = 0; i < iNumToDo; i += 4)
    {
        *Out++ = rsqrt(*In++);
    }
}
```

---

### Newton-Raphson Inverse Reciprocal Approximation

Example A-2 demonstrates Newton-Raphson method for inverse reciprocal approximation using inlined assembly for the Streaming SIMD Extensions, the intrinsics, and the F32vec4 class. The complete sample program, including the code for the accurate Newton-Raphson Methods can be found in the `VTuneEnv\Samples\NRReciprocal` directory of the VTune™ Performance Enhancement Environment CD, version 4.0.

### Example A-2 Newton-Raphson Inverse Reciprocal Approximation

---

```
void RecipApproximationASM(float * lpfInput, float * lpfRecipOutput,
int iNumToDo)
{
    __asm
    {
        mov    esi, lpfInput
```

---

continued

## Example A-2 Newton-Raphson Inverse Reciprocal Approximation (continued)

```
    mov    edi, lpfRecipOutput
    mov    ecx, iNumToDo
    shr   ecx, 4           ; divide by 16, do 16 at a time

    Invert:
    movaps mm0, [esi]
    add   edi, 64

    movaps xmm2, [16][esi]
    movaps xmm4, [32][esi]
    movaps xmm6, [48][esi]
    add   esi, 64

    rcpps xmm1, xmm0
    rcpps xmm3, xmm2
    rcpps xmm5, xmm4
    rcpps xmm7, xmm6

    movaps [-64][edi], xmm1
    movaps [-48][edi], xmm3
    movaps [-32][edi], xmm5
    dec   ecx

    movaps [-16][edi], xmm7
    jnz   Invert
}
}

void RecipApproximationIntrinsics(float * lpfInput, float *
lpfRecipOutput, int iNumToDo)
{
    int i;
    __m128 *In, *Out;
```

---

continued

---

**Example A-2 Newton-Raphson Inverse Reciprocal Approximation (continued)**

---

```
    In = (__m128 *) lpfInput;
    Out = (__m128 *) lpfRecipOutput;

    iNumToDo = iNumToDo >> 2;    ; divide # to do by 4 since we
                                ; are doing 4 with each intrinsic

    for(i = 0; i < iNumToDo; i++)
    {
        *Out++ = _mm_rcp_ps(*In++);
    }
}

void RecipApproximationF32vec4(float * lpfInput, float *
                               lpfRecipOutput, int iNumToDo)
{
    int i;
    F32vec4 *In, *Out;

    In = (F32vec4 *) lpfInput;
    Out = (F32vec4 *) lpfRecipOutput;

    iNumToDo = iNumToDo >> 2;; divide by 4, do 4 at a time

    for(i = 0; i < iNumToDo; i++)
    {
        *Out++ = rcp(*In++);
    }
}
```

---

## 3D Transformation Algorithms

The examples of 3D transformation operations algorithms in this section demonstrate how to write efficient code with Streaming SIMD Extensions. The purpose of these algorithms is to make the transformation and lighting

operations work together efficiently and to use new `prefetch` instructions to reduce memory load latencies. The performance of code using the Streaming SIMD Extensions is around three times better than the original C code.

For complete details, refer to the *Streaming SIMD Extensions -- 3D Transformation*, Intel application note, order number 243831.

## AoS and SoA Data Structures

There are two kinds of data structures: the traditional Array of Structures (AoS), with data organized according to vertices -  $x_0 y_0 z_0$ , and the Structure of Arrays (SoA), with data organized according to coordinates -  $x_0 x_1 x_2 x_3$ . The SoA data structure is a more natural structure for SIMD instructions.

The best performance is achieved by performing the transformation with data in SoA format. However some applications require the data in AoS format. In these cases it is still possible to use Streaming SIMD Extensions, by transposing the data to SoA format before the transformation and lighting operations. After these operations are complete, de-transpose the data back to AoS format.

## Performance Improvements

The performance improvements for the 3D transform algorithms can be achieved by

- using SoA structures
- prefetching data
- avoiding dependency chains

### SoA

The Streaming SIMD Extensions enable increased performance over scalar floating-point code, through utilizing the SIMD feature of these instructions. When the data is arranged in SoA format, one instruction handles four data elements. This arrangement also eliminates loading data that is not relevant for the transformation, such as texture coordinates, color, and spectral information.



## Prefetching

Additional performance gain is achieved by prefetching the data from main memory, and by replacing the long latency `divps` instruction with a low latency `rcpps` instruction, or its Newton-Raphson approximation for better precision. For more information, see the [“Newton-Raphson Method with the Reciprocal Instructions”](#) section earlier in this appendix. For complete details, refer to the *Increasing the Accuracy of the Results from the Reciprocal and Reciprocal Square Root Instructions using the Newton-Raphson Method*, Intel application note, order number 243637.

## Avoiding Dependency Chains

Yet another performance increase can be obtained by avoiding writing code that contains chains of dependent calculations. The dependency problem can occur with the `movhps/movlps/shufps` sequence, since each `movhps/movlps` instruction bypasses part of the destination register. These instructions cannot execute until prior instructions that generate the corresponding register are completed. This dependency can prevent successive loop iterations from executing in parallel.

One solution to this problem is to include a 128-bit load from a dummy local variable to each register used with a `movhps/movlps` instruction. This effectively breaks dependency by performing an independent load from a memory or cached location. In some cases, such as loading a section of a transform matrix, the code that uses the swizzled results already includes 128-bit loads. In these cases, an additional explicit 128-bit dummy load is not required.

## Implementation

The code examples, including a sample program using the techniques described above can be found in the `\VTuneEnv\Samples\3DTrans\aos` and `\VTuneEnv\Samples\3DTrans\soa` directories of the VTune Performance Enhancement Environment, version 4.0. Example A-3 shows the code for the transformation algorithm for the SoA version implemented in scalar C, and the intrinsics and vector class for the Streaming SIMD Extensions.

## Example A-3 Transform SoA Functions, C Code

---

```
void TransformProjectSoA(VerticesList *inp, VerticesList *out, int
count, camera *cam)
{
    int i;
    float x,y,z;
    float orw;

    for (i=0; i<count; i++){
        x = inp->x[i], y = inp->y[i], z = inp->z[i];
        orw = x * mat->_30 + y * mat->_31 + z * mat->_32 +
mat->_33;
        out->x[i] = (x*mat->_00 + y*mat->_01 + z*mat->_02 +
mat->_03)*(cam->sx/orw) + cam->tx;
        out->y[i] = (x*mat->_10 + y*mat->_11 + z*mat->_12 +
mat->_13)*(cam->sy/orw) + cam->ty;
        out->z[i] = (x*mat->_20 + y*mat->_21 + z*mat->_22 +
mat->_23)*(cam->sz/orw) + cam->tz;
        out->w[i] = orw;
    }
}
//-----
// This version uses the intrinsics for the Streaming SIMD
Extensions.
// Note that the F32vec4 can be used in place of __m128 variables as
// operands to the intrinsics.
//-----
void TransformProjectSoAXMMIntrin(VerticesListV *inp, VerticesListV
*out, int count, camera *cam)
{
    int i;
    F32vec4 x, y, z;
    F32vec4 orw;
    F32vec4 SX=cam->sx, SY=cam->sy, SZ=cam->sz;
    F32vec4 TX=cam->tx, TY=cam->ty, TZ=cam->tz;
```

---

continued

**Example A-3 Transform SoA Functions, C Code (continued)**

```

    for (i=0; i<count/VECTOR_SIZE; i++){
        x = inp->x[i], y = inp->y[i], z = inp->z[i];
// orw = x * mat30 + y * mat31 + z * mat32 + mat33;

        orw = (_mm_add_ps(
                _mm_add_ps(
                    _mm_mul_ps(x, mat30),
                    _mm_mul_ps(y, mat31)),
                _mm_add_ps(
                    _mm_mul_ps(z, mat32),
                    mat33)));

// out->x[i] = (x*mat->_00 + y*mat->_01 + z*mat->_02 +
                mat->_03)*(cam->sx/orw) + cam->tx;
        out->x[i] = (_mm_add_ps(
                _mm_mul_ps(
                    _mm_add_ps(
                        _mm_add_ps(
                            _mm_mul_ps(x, mat00),
                            _mm_mul_ps(y, mat01)),
                        _mm_add_ps(
                            _mm_mul_ps(z, mat02),
                            mat03)),
                    _mm_div_ps(SX, orw)),
                TX));

// out->y[i] = (x*mat->_10 + y*mat->_11 + z*mat->_12 +
                mat->_13)*(cam->sy/orw) + cam->ty;
        out->y[i] = (_mm_add_ps(
                _mm_mul_ps(
                    _mm_add_ps(
                        _mm_add_ps(
                            _mm_mul_ps(x, mat10),

```

continued

## Example A-3 Transform SoA Functions, C Code (continued)

```
        _mm_mul_ps(y, mat11)),
        _mm_add_ps(
            _mm_mul_ps(z, mat12),
            mat13)),
        _mm_div_ps(SY, orw)),
        TY));

// out->z[i] = (x*mat->_20 + y*mat->_21 + z*mat->_22 +
mat->_23)*(cam->sz/orw) + cam->tz;
    out->z[i] = (_mm_add_ps(
        _mm_mul_ps(
            _mm_add_ps(
                _mm_add_ps(
                    _mm_mul_ps(x, mat20),
                    _mm_mul_ps(y, mat21)),
                _mm_add_ps(
                    _mm_mul_ps(z, mat22),
                    mat23)),
                _mm_div_ps(SZ, orw)),
            TZ));

        out->w[i] = orw;
    }

}

//-----
// This version uses the F32vec4 class abstraction for the Streaming
// SIMD Extensions intrinsics.
//-----
void TransformProjectSoAXMMFvec(VerticesListV *inp, VerticesListV
*out, int count, camera *cam)
{
```

continued

---

**Example A-3 Transform SoA Functions, C Code (continued)**

---

```
int i;
F32vec4 x, y, z;
F32vec4 orw;
F32vec4 SX=cam->sx, SY=cam->sy, SZ=cam->sz;
F32vec4 TX=cam->tx, TY=cam->ty, TZ=cam->tz;
for (i=0; i<count/VECTOR_SIZE; i++){
    x = inp->x[i], y = inp->y[i], z = inp->z[i];
    orw = x * mat30 + y * mat31 + z * mat32 + mat33;
    out->x[i] =
        (((x * mat00) + (y * mat01) + (z * mat02) +
         mat03) * (SX/orw)) + TX;
    out->y[i] =
        (((x * mat10) + (y * mat11) + (z * mat12) +
         mat13) * (SY/orw)) + TY;
    out->z[i] =
        (((x * mat20) + (y * mat21) + (z * mat22) +
         mat23) * (SZ/orw)) + TZ;
    out->w[i] = (orw);
}
```

---

**Assembly Code for SoA Transformation**

The sample assembly code is an optimized example of transformation of data in SoA format. You can find the code in [\VTuneEnv\Samples\3dTrans\soa\soa.asm](#) file of the VTune Performance Enhancement Environment CD, version 4.0.

In the optimized code the instructions are rescheduled to expose more parallelism to the processor. The basic code is composed of four independent blocks, inhibiting parallel execution. The instructions in each block are data-dependent. In the following optimized code the instructions of each two adjacent blocks are interleaved, enabling much more parallel execution.

This optimization assumes that the vertices data is already in the cache. If the data is not in the cache, this code becomes memory-bound. In this case, try to add more computations within the loop, for example, lighting calculations. Another option is to prefetch the data, using the Streaming SIMD Extensions prefetch instruction.

## Motion Estimation

This section explains how to use the Streaming SIMD Extensions and MMX™ technology instructions to perform motion estimation (ME) for the MPEG Encoder. Motion estimation (ME) is a video compression technique performed during video stream encoding. ME benefits situations in which –

- most of the object's characteristics, such as shape and orientation, stay the same from frame to frame
- only the object's position within the frame changes.

The ME module in most encoders is very computation-intensive, so it is desirable to optimize it as much as possible.

For complete details, see the *Using Streaming SIMD Extensions in a Motion Estimation Algorithm for MPEG Encoding*, Intel application note, order number 243652.

This section includes code examples that implement the new instructions. In particular, they illustrate the use of the packed sum of absolute differences (`psadbw`) instruction to implement a fast motion-estimation error function.

## Performance Improvements

The Streaming SIMD Extensions code improves ME performance using the following techniques:

- Implementing `psadbw` instruction to calculate a sum of absolute differences for 16 pixels. With MMX technology, the code requires about 20 MMX instructions, including packed subtract, packed addition, logical, and unpack instructions. The same calculation with Streaming SIMD Extensions requires only two `psadbw` instructions.
- Reducing potential delays due to branch mispredictions by using absolute difference calculation which does not contain any branch instructions.

- Using search algorithm with block-by-block comparisons for error calculation.
- Unrolling the loop saves four times on loop overhead, that is, fewer instructions are executed.

### Sum of Absolute Differences

The motion estimation module in most encoders is very computation-intensive, due to the large number of block-by-block comparisons. Streaming SIMD Extensions provide a fast way of performing the fundamental motion-error calculation using the `psadbw` instruction to compute the absolute difference of unsigned, packed bytes. Overall, the Streaming SIMD Extensions implementation of this error function yields a 1.7 performance improvement over the MMX technology implementation.

### Prefetching

The `prefetch` instruction also improves performance by prefetching the data of the estimated block. Since precise block position in the estimated frame is known, `prefetch` can be used once every two blocks to prefetch sixteen 32-byte cache lines for the two next blocks. To avoid prefetching more than once, the `prefetch` instruction must be placed outside of the loop of motion vector search.

## Implementation

The complete sample program for the scalar C, SIMD integer, and SIMD floating-point assembly versions of the Motion Estimation algorithm can be found in the `\VTuneEnv\Samples\MotionEst` directory of the VTune Performance Enhancement Environment CD, version 4.0.

## Upsample

This section presents an algorithm called “smoothed upsample” which is a subset of a more general class called a “resample” algorithm. Smoothed upsampling attempts to make a better “guess” at the original signal shape by fitting a smooth curve through four adjacent sample points and taking new

samples only between the center two samples. This is intended to minimize the introduction of false higher-frequency components and better match the original signal shape.

This algorithm could be applied to any sequential sample stream either to increase the number of samples, or it can be used as the first step in reducing the number of samples. In the latter case, the smoothed upsample algorithm would be followed by application of a filter to produce a smaller number of samples.

The Streaming SIMD Extensions can provide performance improvements for smoothed upsampling, and in general, for any type of “resampling” algorithm.

For complete details, see the *A Smoothed Upsample Algorithm using Streaming SIMD Extensions*, Intel application note, order number 243656.

## Performance Improvements

The performance gain of the smoothed upsample algorithm with the Streaming SIMD Extensions for the assembly code is from 3.9 to 5.9 times faster than the C code, while the intrinsic code is from 3.4 to 5.2 times faster than the C code.

While a hand-coded x87 version of the algorithm was not implemented, typical performance improvement of x87 over a version coded in C is 25%—and hence approximately half as fast as the Streaming SIMD Extensions implementation.

To convert one second of 22 kHz audio samples to one second of 44 kHz audio samples, the Streaming SIMD Extensions version would require only about 1.3 to 1.9 million clocks – a trivial fraction of one second’s processing on a Pentium III processor.

## Streaming SIMD Extensions Implementation of the Upsampling Algorithm

The complete sample program for the scalar C, and SIMD-floating point (intrinsics and vector class) versions of the Upsample algorithm can be found in the `\VTuneEnv\Samples\Upsample` directory of the VTune Performance Enhancement Environment CD, version 4.0.



The performance of optimized assembly version of the smoothed upsample algorithm with the Streaming SIMD Extensions can be compared to the C version of the same algorithm, intrinsics version in C++, or to the FVEC class library version also in C++. The assembly version is substantially faster than the C version.

## FIR Filter Algorithm Using Streaming SIMD Extensions

This section discusses the algorithm for both real and complex 16-tap finite duration impulse response (FIR) filter using Streaming SIMD Extensions technology and includes code examples that illustrate the implementation of the Streaming SIMD Extensions SIMD instruction set.

For complete details refer to the *32-bit Floating Point Real & Complex 16-Tap FIR Filter Implemented Using Streaming SIMD Extensions*, Intel application note, order number 243643.

### Performance Improvements for Real FIR Filter

The following sections discuss considerations and techniques used to optimize the performance of the Streaming SIMD Extensions code for the real 16-tap FIR filter algorithm. These techniques are generally applicable to optimizing Streaming SIMD Extensions code on the Pentium III architecture.

#### Parallel Multiplication and Interleaved Additions

Use parallel multiplications and the CPU-bound interleaved additions to increase the number of memory accesses for FIR filter. All Streaming SIMD Extensions translate to at least two micro-ops. When a large number of Streaming SIMD Extensions are used consecutively, the resulting micro-ops retire quickly which slows down the performance of the decoder.

#### Reducing Data Dependency and Register Pressure

In the optimized version of the Streaming SIMD Extensions technology, registers were reallocated, at several points, to reduce register pressure and increase opportunities for rescheduling instructions. The primary example

of this is the use of `xmm0` to perform parallel multiplications. In the unoptimized version, `xmm0` is used exclusively to access data from the input array and perform the multiplication against the coefficient array. In the optimized version, `xmm4` and `xmm7` are implemented to alleviate pressure from `xmm0`. While `xmm4` is used to compute values for both `y(n+1)` and `y(n+3)`, the only other connection between the parallel multiplies is the use of `xmm1` to hold a copy of the input values used by the other registers. This results in a few very precise dependencies on the parallel portion of the algorithm, and increases the opportunities for rescheduling instructions.

### Scheduling for the Reorder Buffer and the Reservation Station

Keeping track of the number of micro-ops in the reorder buffer (ROB) and the Reservation Station is another optimizing technique used for the Streaming SIMD Extensions code. Ideally neither the ROB nor the Reservation Station should become saturated with micro-ops (limit is 40 for the ROB, 20 for the Reservation Station). Usually, the saturation can be eliminated through careful scheduling of instructions targeted to different CPU ports, and by taking into account instruction latencies when scheduling.

### Wrapping the Loop Around (Software Pipelining)

The interleaved additions at the end of the loop are completely CPU-bound and very dependent upon one another. The result of this is that the ROB and the Reservation Station quickly saturate, preventing new micro-ops from entering the ROB. Due to data dependencies, the instructions could not be rescheduled very far back into the main loop body. To alleviate this condition, the first set of multiplies (against the first column of coefficients) and the loop control instructions were pulled out of the top of the loop and a copy placed at the bottom. While this increased the size of the code, the resulting opportunities for instruction scheduling prevented the saturation of the ROB and Reservation Station while improving the overall throughput of the loop. A second copy of the instructions must be placed outside the top of the loop to “prime” the loop for its first iteration.

## Advancing Memory Loads

Memory accesses require a minimum of three clock cycles to complete if there is a cache hit on the L1 cache. These potentially long latencies should be addressed by scheduling memory accesses as early and as far away as possible from the use of the accessed data. It is also helpful to retain data accessed from memory within the CPU for as long as possible to reduce the need to re-read the data from memory. You can observe this in the FIR filter performance when using the `xmm1` as a storage area to hold four input values while they are multiplied by four different sets of coefficients.

## Separating Memory Accesses from Operations

Separating memory accesses from operations that use the accessed data allows the micro-ops generated to access memory to retire before the micro-ops which actually perform the operation. If a memory access is combined with an operation, all the micro-ops generated by the instruction wait to retire until the last micro-op is finished. This can leave micro-ops used to access memory waiting to retire in the ROB for multiple clocks, taking up valuable buffer space. Compare the unoptimized code to the optimized code for performing multiplications against the coefficient data in the example that follows.

### Unoptimized code:

```
movaps xmm0, xmm1;           ; Reload [n-13:n-16] for new product
mulps  xmm0, [eax + 160];     ; xmm0 = input [n-13:n-16] * c2_4
```

### Optimized code:

```
movaps xmm4, [eax + 160 - 32]; ; Load c2_2 for new product
mulps  xmm4, xmm1;           ; xmm4 = input [n-5:n-8] * c2_2
```

## Unrolling the Loop

The C code of the FIR filter has two loops: an outer loop to move upward through the input values, and an inner loop to perform the dot product between the input and taps arrays for each output value. With Streaming SIMD Extensions technology, the inner loop can be unrolled and only a single loop can control the function.

Loop unrolling benefits performance in two ways: it lessens the incidence of branch misprediction by removing a conditional jump and it increases the “pool” of instructions available for re-ordering and scheduling of the processor. Keep in mind though that loop unrolling makes the code larger. Consider whether you need to gain in performance or in code size.

### Minimizing Pointer Arithmetic/Eliminating Unnecessary Micro-ops

In the unoptimized version, the pointer arithmetic is explicit to allow for a detailed explanation of the accesses into the taps arrays. In the optimized version, the explicit arithmetic is converted to implicit address calculations contained in memory accesses. This conversion reduces the number of non-essential micro-ops generated by the core of the loop and the goal of optimization is to eliminate unnecessary micro-ops whenever possible.

### Prefetch Hints

Because the FIR filter input data is likely to be in cache, due to the fact that the data was recently accessed to build the input vector, a prefetch hint was included to pre-load the next cache line worth of data from the input array. Accesses to the taps arrays and to the historical input data occur every iteration of the loop to maintain good temporal locality after their initial access. Keep in mind though that the processor will not follow all of the hints and therefore the performance benefits of the prefetch hint can be questionable.

### Minimizing Cache Pollution on Write

The way the output vector is used influences the method of data storage. Basically, either the output vector (in the calling program) is used soon after it is populated, or it will not be accessed for some time. In the first case, the `movaps` instruction should be used to write out the data. In the second case, if the output vector is not used for some time, it may be wise to minimize cache pollution by using the `movntps` instruction.

## Performance Improvements for the Complex FIR Filter

The techniques described for real FIR filter above apply to the complex 16-tap FIR filter as well. The following sections discuss a few particular techniques applicable to the complex FIR filters.

### Unrolling the Loop

The change to the taps array increases the number of iterations of the inner loop of the basic FIR algorithm. This, combined with an increased number of instructions due to the complex multiply, results in many more instructions when the loop is unrolled, and the code size increases. However, if the loop is not unrolled, the algorithm produces a branch misprediction and pipeline stall for every iteration of the outer loop.

To reduce branch mispredictions and minimize code size, the inner loop may be unrolled only enough times to reduce the number of iterations to four because the architecture only supports four bits of branch history (a four-branch history) in its branch prediction mechanism.

### Reducing Non-Value-Added Instructions

To limit the use of shuffle, unpack, and move instructions in an algorithm is desirable because these instructions do not perform any arithmetic function on the data and are basically “non-value added.” An alternative data storage format, geared towards parallel (or SIMD) processing, eliminates the need to shuffle the complex numbers to enable complex multiplies. However, sometimes the SIMD structures do not fit well with the object-orientated programming. The tradeoff of eliminating “non-value added” instructions is a speed-up resulting from this elimination versus how much overhead is necessary to use the SIMD data structures before executing the function.

### Complex FIR Filter Using a SIMD Data Structure

The definition of SIMD techniques is that a single instruction operates upon multiple data elements of the same type. A more efficient version of the complex multiply can be implemented if the real and imaginary components of the complex numbers are stored separately, in their own arrays.

## Code Samples

The complete sample program code for the scalar C, and SIMD floating-point (intrinsics and vector class) versions of the Upsample algorithm can be found in the *32-bit Floating Point Real & Complex 16-Tap FIR Filter Implemented Using Streaming SIMD Extensions*, Intel application note, order number 243643, the `\VTuneEnv\Training\rc_fir.pdf` file of the VTune Performance Enhancement Environment CD, version 4.0.

# *Performance-Monitoring Events and Counters*

---

## B

This appendix describes the performance-affecting events counted by the counters on Pentium® II and Pentium III processors.

The most effective way to improve the performance of application is to determine the areas of performance losses in the code and remedy the stall conditions. In order to identify stall conditions, Pentium II and Pentium III processors include two counters that allow you to gather information about the performance of applications by keeping track of events during your code execution. The counters provide information that allows you to determine if and where an application has stalls.

The counters can be accessed by using Intel's VTune™ Performance Analyzer or by using the performance counter instructions within the application code.

## **Performance-affecting Events**

This section presents Table B-1 that lists those events which can be counted with the performance-monitoring counters and read with the **RDPMC** instruction.

The columns in the table are as follows:

- The Unit column gives the micro-architecture or bus unit that produces the event.
- The Event Number column gives the hexadecimal number identifying the event.
- The Mnemonic Event Name column gives the name of the event.
- The Unit Mask column gives the unit mask required (if any).

- The Description column.
- The Comments column gives additional information about the event.

These performance-monitoring events are intended as guides for performance tuning. The counter values reported are not always absolutely accurate and should be used as a relative guide for tuning. Known discrepancies are documented where applicable. All performance events are model-specific to the Pentium II and Pentium III processors and are not architecturally guaranteed in future versions of the processors. All performance event encodings not listed in the table are reserved and their use will result in undefined counter results.

**Table B-1 Performance Monitoring Events**

Unit	Event No.	Mnemonic Event Name	Unit Mask	Description	Comments
Data Cache Unit (DCU)	43H	DATA_MEM_R EFS	00H	All loads from any memory type. All stores to any memory type. Each part of a split is counted separately. <b>NOTE:</b> 80-bit floating-point accesses are double counted, since they are decomposed into a 16-bit exponent load and a 64-bit mantissa load. Memory accesses are only counted when they are actually performed, e.g., a load that gets squashed because a previous cache miss is outstanding to the same address, and which finally gets performed, is only counted once. Does not include I/O accesses, or other non-memory accesses.	
	45H	DCU_LINES_IN	00H	Total number of lines that have been allocated in the DCU.	
	46H	DCU_M_LINES_IN	00H	Number of Modified state lines that have been allocated in the DCU.	

continued



**Table B-1 Performance Monitoring Events (continued)**

Unit	Event No.	Mnemonic Event Name	Unit Mask	Description	Comments
Data Cache Unit (DCU) (cont'd)	47H	DCU_M_LINES_OUT	00H	Number of Modified state lines that have been evicted from the DCU. This includes evictions as a result of external snoops, internal intervention, or the natural replacement algorithm.	
	48H	DCU_MISS_OUTSTANDING	00H	Weighted number of cycles while a DCU miss is outstanding. Incremented by the number of outstanding cache misses at any particular time. Cacheable read requests only are considered. Uncacheable requests are excluded. Read-for-ownerships are counted as well as line fills, invalidates, and stores.	An access that also misses the L2 is short-changed by two cycles. (i.e. if count is N cycles, should be N+2 cycles.) Subsequent loads to the same cache line will not result in any additional counts. Count value not precise, but still useful.
Instruction Fetch Unit (IFU)	80H	IFU_FETCH	00H	Number of instruction fetches, both cacheable and non-cacheable. Including UC fetches.	Will be incremented by 1 for each cacheable line fetched and by 1 for each uncached instruction fetched.
	81H	IFU_FETCH_MISS	00H	Number of instruction fetch misses. All instruction fetches that do not hit the IFU i.e. that produce memory requests. Includes UC accesses.	
	85H	ITLB_MISS	00H	Number of ITLB misses.	
	86H	IFU_MEM_STALL	00H	Number of cycles instruction fetch is stalled, for any reason. Includes IFU cache misses, ITLB misses, ITLB faults, and other minor stalls.	
	87H	ILD_STALL	00H	Number of cycles that the instruction length decoder stage of the processors pipeline is stalled.	

continued

**Table B-1 Performance Monitoring Events (continued)**

Unit	Event No.	Mnemonic Event Name	Unit Mask	Description	Comments
L2 Cache	28H	L2_IFETCH	MESI 0FH	Number of L2 instruction fetches. This event indicates that a normal instruction fetch was received by the L2. The count includes only L2 cacheable instruction fetches; it does not include UC instruction fetches. It does not include ITLB miss accesses.	
	2AH	L2_ST	MESI 0FH	Number of L2 data stores. This event indicates that a normal, unlocked, store memory access was received by the L2. Specifically, it indicates that the DCU sent a read-for-ownership request to the L2. It also includes Invalid to Modified requests sent by the DCU to the L2. It includes only L2 cacheable store memory accesses; it does not include I/O accesses, other non-memory accesses, or memory accesses like UC/WT stores. It includes TLB miss memory accesses.	
	24H	L2_LINES_IN	00H	Number of lines allocated in the L2.	
	26H	L2_LINES_OUT	00H	Number of lines removed from the L2 for any reason.	
	25H	L2_LINES_INM	00H	Number of Modified state lines allocated in the L2.	
	27H	L2_LINES_OUTM	00H	Number of Modified state lines removed from the L2 for any reason.	
	2EH	L2_RQSTS	MESI 0FH	Total number of all L2 requests.	
	21H	L2_ADS	00H	Number of L2 address strobes.	
	22H	L2_DBUS_BUSY	00H	Number of cycles during which the L2 cache data bus was busy.	

continued

**Table B-1 Performance Monitoring Events (continued)**

Unit	Event No.	Mnemonic Event Name	Unit Mask	Description	Comments
L2 Cache (cont'd)	23H	L2_DBUS_BUSY_RD	00H	Number of cycles during which the data bus was busy transferring read data from L2 to the processor.	
External Bus Logic (EBL)	62H	BUS_DRDY_CLOCKS	00H (self) 20H (any)	Number of clocks during which DRDY# is asserted. Essentially, utilization of the external system data bus.	Unit Mask = 00H counts bus clocks when the processor is driving DRDY Unit Mask = 20H counts in processor clocks when any agent is driving DRDY.
	63H	BUS_LOCK_CLOCKS	00H (self) 20H (any)	Number of clocks during which LOCK# is asserted on the external system bus.	Always counts in processor clocks.
	60H	BUS_REQ_O UTSTANDING	00H (self)	Number of bus requests outstanding. This counter is incremented by the number of cacheable read bus requests outstanding in any given cycle.	Counts only DCU full-line cacheable reads, not Reads for ownership, writes, instruction fetches, or anything else. Counts "waiting for bus to complete" (last data chunk received).
	65H	BUS_TRAN_BRD	00H (self) 20H (any)	Number of bus burst read transactions.	
	66H	BUS_TRAN_RFO	00H (self) 20H (any)	Number of completed bus read for ownership transactions.	
	67H	BUS_TRAN_WB	00H (self) 20H (any)	Number of completed bus write back transactions.	
	68H	BUS_TRAN_IFETCH	00H (self) 20H (any)	Number of completed bus unstruction fetch transactions.	

continued

**Table B-1 Performance Monitoring Events (continued)**

Unit	Event No.	Mnemonic Event Name	Unit Mask	Description	Comments
External Bus Logic (EBL) (cont'd)	69H	BUS_TRAN_INVALID	00H (self) 20H (any)	Number of completed bus invalidate transactions.	
	6AH	BUS_TRAN_PWR	00H (self) 20H (any)	Number of completed bus partial write transactions.	
	6BH	BUS_TRAN_P	00H (self) 20H (any)	Number of completed bus partial transactions.	
	6CH	BUS_TRAN_IO	00H (self) 20H (any)	Number of completed bus I/O transactions.	
	6DH	BUS_TRAN_DEF	00H (self) 20H (any)	Number of completed bus deferred transactions.	
	6EH	BUS_TRAN_BURST	00H (self) 20H (any)	Number of completed bus burst transactions.	
	70H	BUS_TRAN_ANY	00H (self) 20H (any)	Number of all completed bus transactions. Address bus utilization can be calculated knowing the minimum address bus occupancy. Includes special cycles etc.	
	6FH	BUS_TRAN_MEM	00H (self) 20H (any)	Number of completed memory transactions.	
	64H	BUS_DATA_RCV	00H (self)	Number of bus clock cycles during which this processor is receiving data.	

continued

**Table B-1 Performance Monitoring Events (continued)**

Unit	Event No.	Mnemonic Event Name	Unit Mask	Description	Comments
EBL (cont'd)	61H	BUS_BNR_DRV	00H (self)	Number of bus clock cycles during which this processor is driving the BNR pin.	
	7AH	BUS_HIT_DRV	00H (self)	Number of bus clock cycles during which this processor is driving the HIT pin.	Includes cycles due to snoop stalls.
	7BH	BUS_HITM_DRV	00H (self)	Number of bus clock cycles during which this processor is driving the HITM pin.	Includes cycles due to snoop stalls.
	7EH	BUS_SNOOP_STALL	00H (self)	Number of bus clock cycles during which the bus is snoop stalled.	
Floating-point Unit	C1H	FLOPS	00H	Number of computational floating-point operations retired. Excludes floating-point computational operations that cause traps or assists. Includes floating-point computational operations executed by the assist handler. Includes internal sub-operations of complex floating-point instructions such as a transcendental instruction. Excludes floating-point loads and stores.	Counter 0 only.
	10H	FP_COMP_OPS_EXE	00H	Number of computational floating-point operations executed including FADD, FSUB, FCOM, FMULs, integer MULs and IMULs, FDIVs, FPREMs, FSQRTS, integer DIVs and IDIVs. <b>NOTE:</b> counts the number of operations not number of cycles. This event does not distinguish an FADD used in the middle of a transcendental flow from a separate FADD instruction.	Counter 0 only.
	11H	FP_ASSIST	00H	Number of floating-point exception cases handled by microcode.	Counter 1 only. This event includes counts due to speculative execution.

continued

**Table B-1 Performance Monitoring Events (continued)**

Unit	Event No.	Mnemonic Event Name	Unit Mask	Description	Comments
Floating-point Unit (cont'd)	12H	MUL	00H	Number of multiplies. <b>NOTE:</b> includes integer and FP multiplies.	Counter 1 only. This event includes counts due to speculative execution.
	13H	DIV	00H	Number of divides. <b>NOTE:</b> includes integer and FP multiplies.	Counter 1 only. This event includes counts due to speculative execution.
	14H	CYCLES_DIV BUSY	00H	Number of cycles that the divider is busy, and cannot accept new divides. <b>NOTE:</b> includes integer and FP divides, FPREM, FPSQRT, etc. Counter 0 only. This event includes counts due to speculative execution.	Counter 0 only. This event includes counts due to speculative execution.
Memory Ordering	03H	LD_BLOCKS	00H	Number of store buffer blocks. Includes counts caused by preceding stores whose addresses are unknown, preceding stores whose addresses are known to conflict, but whose data is unknown and preceding stores that conflict with the load, but which incompletely overlap the load.	
	04H	SB_DRAINS	00H	Number of store buffer drain cycles. Incremented during every cycle the store buffer is draining. Draining is caused by serializing operations like CPUID, synchronizing operations like XCHG, Interrupt acknowledgment, as well as other conditions such as cache flushing.	

continued

**Table B-1 Performance Monitoring Events (continued)**

Unit	Event No.	Mnemonic Event Name	Unit Mask	Description	Comments
Memory Ordering (cont'd)	05H	MISALIGN_MEM_REF	00H	Number of misaligned data memory references. Incremented by 1 every cycle during which either the processor load or store pipeline dispatches a misaligned $\mu$ op. Counting is performed if its the first half or second half, or if it is blocked, squashed or misses. <b>NOTE:</b> in this context misaligned means crossing a 64-bit boundary.	It should be noted that MISALIGN_MEM_REF is only an approximation, to the true number of misaligned memory references. The value returned is roughly proportional to the number of misaligned memory accesses, i.e., the size of the problem.
Instruction Decoding and Retirement	C0H	INST_RETIRE	00H	Total number of instructions retired.	
	C2H	$\mu$ OPS_RETIRE	00H	Total number of $\mu$ ops retired.	
	D0H	INST_DECODER	00H	Total number of instructions decoded..	
Interrupts	C8H	HW_INT_RX	00H	Total number of hardware interrupts received.	
	C6H	CYCLES_INT_MASKED	00H	Total number of processor cycles for which interrupts are disabled.	
	C7H	CYCLES_INT_PENDING_AND_MASKED	00H	Total number of processor cycles for which interrupts are disabled and interrupts are pending.	
Branches	C4H	BR_INST_RETIRE	00H	Total number of branch instructions retired.	
	C5H	BR_INST_PRED_RETIRE	00H	Total number of branch mispredictions that get to the point of retirement. Includes not taken conditional branches.	
	C9H	BR_TAKEN_RETIRE	00H	Total number of taken branches retired.	

continued

**Table B-1 Performance Monitoring Events (continued)**

Unit	Event No.	Mnemonic Event Name	Unit Mask	Description	Comments
Branches (cont'd)	CAH	BR_MISS_PRED_TAKEN_RET	00H	Total number of taken but mispredicted branches that get to the point of retirement. Includes conditional branches only when taken.	
	E0H	BR_INST_DECODED	00H	Total number of branch instructions decoded.	
	E2H	BTB_MISSES	00H	Total number of branches that the BTB did not produce a prediction for.	
	E4H	BR_BOGUS	00H	Total number of branch predictions that are generated but are not actually branches.	
	E6H	BACLEAR	00H	Total number of time BACLEAR is asserted. This is the number of times that a static branch prediction was made by the decoder.	
Stalls	A2H	RESOURCE_STALLS	00H	Incremented by one during every cycle that there is a resource related stall. Includes register renaming buffer entries, memory buffer entries. Does not include stalls due to bus queue full, too many cache misses, etc. In addition to resource related stalls, this event counts some other events. Includes stalls arising during branch misprediction recovery e.g. if retirement of the mispredicted branch is delayed and stalls arising while store buffer is draining from synchronizing operations.	
	D2H	PARTIAL_RAT_STALLS	00H	Number of cycles or events for partial stalls. <b>NOTE:</b> Includes flag partial stalls.	

continued



**Table B-1 Performance Monitoring Events (continued)**

Unit	Event No.	Mnemonic Event Name	Unit Mask	Description	Comments
Segment Register Loads	06H	SEGMENT_REG_LOADS	00H	Number of segment register loads.	
Clocks	79H	CPU_CLK_UNHALTED	00H	Number of cycles during which the processor is not halted.	
MMX Instructions Executed	B0H	MMX_INSTR_EXEC	00H	Number of MMX instructions executed.	
			01H	MMX Packed multiply instructions executed.	
			02H	MMX Packed shift instructions executed.	
			04H	MMX Packed operations instructions executed.	
	B3H (cont'd)	MMX_INSTR_TYPE_EXEC (cont'd)	08H	MMX Unpack operations instructions executed.	
			10H	MMX Packed logical instructions executed.	
MMX Saturated Instructions Executed	B1H	MMX_SAT_INSTR_EXEC	00H		
			20H	MMX Packed arithmetic instructions executed.	
MMX $\mu$ ops executed	B2H	MMX_ $\mu$ OPS_EXEC	0FH	Number of MMX $\mu$ ops executed.	
MMX Transitions	CCH	FP_MMX_TRANS	00H	Transitions from MMX instruction to FP instructions.	
			01H	Transitions from FP instructions to MMX instructions.	
MMX Assists	CDH	MMX_ASSIST	00H	Number of MMX Assists.	MMX Assists is the number of EMMS instructions executed.
MMX Instructions Retired	CEH	MMX_INSTR_RET	00H	Number of MMX instructions retired.	

continued

**Table B-1 Performance Monitoring Events (continued)**

Unit	Event No.	Mnemonic Event Name	Unit Mask	Description	Comments
Segment Register Renaming Stalls	D4H	SEG_RENAM E_STALLS	01H	Segment register ES	
			02H	Segment register DS	
			04H	Segment register FS	
			08H	Segment register FS	
			0FH	Segment registers ES + DS + FS + GS	
Segment Registers Renamed	D5H	SEG_REG_ RENAMES	01H	Segment register ES	
			02H	Segment register DS	
			04H	Segment register FS	
			08H	Segment register FS	
			0FH	Segment registers ES + DS + FS + GS	
Segment Registers Renamed & Retired	D6H	RET_SEG_ RENAMES	00H	Number of segment register rename events retired.	
Execution Cluster	D8H	EMON_SSE_ INST_ RETIRED	00H	0: packed and scalar	Number of Streaming SIMD Extensions retired
			01H	1: scalar	
	D9H	EMON_SSE_ COMP_INST_ RET	00H	0: packed and scalar	Number of Streaming SIMD Extensions computation instructions retired.
			01H	1: scalar	
Memory Cluster	07H	EMON_SSE_ PRE_ DISPATCHED	00H	0: prefetchNTA	Number of prefetch/weakly-ordered instructions dispatched (speculative prefetches are included in counting)
			01H	1: prefetchT0	
			02H	2: prefetchT1, prefetchT2	
	4BH	EMON_SSE_ PRE_MISS	00H	0: prefetchNTA	Number of prefetch/weakly-ordered instructions that miss all caches.
			01H	1: prefetchT0	
			02H	2: prefetchT1, prefetchT2	
			03H	3: weakly ordered stores	

## Programming Notes

Please take into consideration the following notes when using the information provided in Table B-1:

- Several L2 cache events, where noted, can be further qualified using the Unit Mask (UMSK) field in the `PerfEvtSel0` and `PerfEvtSel1` registers. The lower four bits of the Unit Mask field are used in conjunction with L2 events to indicate the cache state or cache states involved. The Pentium II and Pentium III processors identify cache states using the “MESI” protocol, and consequently each bit in the Unit Mask field represents one of the four states: `UMSK[3] = M (8h)` state, `UMSK[2] = E (4h)` state, `UMSK[1] = S (2h)` state, and `UMSK[0] = I (1h)` state. `UMSK[3:0] = MESI (Fh)` should be used to collect data for all states; `UMSK = 0h`, for the applicable events, will result in nothing being counted.
- All of the external bus logic (EBL) events, except where noted, can be further qualified using the Unit Mask (UMSK) field in the `PerfEvtSel0` and `PerfEvtSel1` registers. Bit 5 of the UMSK field is used in conjunction with the EBL events to indicate whether the processor should count transactions that are self generated (`UMSK[5] = 0`) or transactions that result from any processor on the bus (`UMSK[5] = 1`).

## RDPMC Instruction

The `RDPMC` (Read Processor Monitor Counter) instruction is used to read the performance-monitoring counters in `CPL=3` if bit 8 is set in the `CR4` register (`CR4.PCE`). This is similar to the `RDTSC` (Read Time Stamp Counter) instruction, which is enabled in `CPL=3` if the Time Stamp Disable bit in `CR4` (`CR4.TSD`) is not disabled. Note that access to the performance-monitoring Control and Event Select Register (`CESR`) is not possible in `CPL=3`.

### Instruction Specification

<b>Opcode</b>	0F 33
<b>Description</b>	Read event monitor counters indicated by <code>ECX</code> into <code>EDX:EAX</code>
<b>Operation</b>	<code>EDX:EAX</code> ← Event Counter [ <code>ECX</code> ]

The value in `ECX` (either 0 or 1) specifies one of the two 40-bit event counters of the processor. `EDX` is loaded with the high-order 32 bits, and `EAX` with the low-order 32 bits.

```
IF CR4.PCE = 0 AND CPL <> 0 THEN #GP(0)
IF ECX = 0 THEN EDX:EAX := PerfCntr0
IF ECX = 1 THEN EDX:EAX := PerfCntr1
ELSE #GP(0)
END IF
```

### Protected and Real Address Mode Exceptions

`#GP(0)` if `ECX` does not specify a valid counter (either 0 or 1).

`#GP(0)` if `RDPMC` is used in `CPL<> 0` and `CR4.PCE = 0`

### 16-bit code

`RDPMC` will execute in 16-bit code and VM mode but will give a 32-bit result. It will use the full `ECX` index.

# Instruction to Decoder Specification

# C

This appendix contains two tables presenting instruction to decoder specifications for the general instructions of the Pentium® II and Pentium III processors (Table C-1) and MMX™ technology instructions (Table C-2).

**Table C-1 Pentium II and Pentium III Processors Instruction to Decoder Specification**

Instruction	# of μops	Instruction	# of μops
AAA	1	ADC rm8,r8	2
AAD	3	ADD AL,imm8	1
AAM	4	ADD eAX,imm16/32	1
AAS	1	ADD m16/32,imm16/32	4
ADC AL,imm8	2	ADD m16/32,r16/32	4
ADC eAX,imm16/32	2	ADD m8,imm8	4
ADC m16/32,imm16/32	4	ADD m8,r8	4
ADC m16/32,r16/32	4	ADD r16/32,imm16/32	1
ADC m8,imm8	4	ADD r16/32,imm8	1
ADC m8,r8	4	ADD r16/32,m16/32	2
ADC r16/32,imm16/32	2	ADD r16/32,rm16/32	1
ADC r16/32,m16/32	3	ADD r8,imm8	1
ADC r16/32,rm16/32	2	ADD r8,m8	2
ADC r8,imm8	2	ADD r8,rm8	1
ADC r8,m8	3	ADD rm16/32,r16/32	1

continued

**Table C-1 Pentium II and Pentium III Processors Instruction to Decoder Specification (continued)**

<b>Instruction</b>	<b># of μops</b>	<b>Instruction</b>	<b># of μops</b>
ADC r8,rm8	2	ADD rm8,r8	1
ADC rm16/32,r16/32	2	AND AL,imm8	1
AND eAX,imm16/32	1	BTC rm16/32, r16/32	1
AND m16/32,imm16/32	4	BTR m16/32, imm8	4
AND m16/32,r16/32	4	BTR m16/32, r16/32	complex
AND m8,imm8	4	BTR rm16/32, imm8	1
AND m8,r8	4	BTR rm16/32, r16/32	1
AND r16/32,imm16/32	1	BTS m16/32, imm8	4
AND r16/32,imm8	1	BTS m16/32, r16/32	complex
AND r16/32,m16/32	2	BTS rm16/32, imm8	1
AND r16/32,rm16/32	1	BTS rm16/32, r16/32	1
AND r8,imm8	1	CALL m16/32 near	complex
AND r8,m8	2	CALL m16	complex
AND r8,rm8	1	CALL ptr16	complex
AND rm16/32,r16/32	1	CALL r16/32 near	complex
AND rm8,r8	1	CALL rel16/32 near	4
ARPL m16	complex	CBW	1
ARPL rm16, r16	complex	CLC	1
BOUND r16,m16/32&16/32	complex	CLD	4
BSF r16/32,m16/32	3	CLI	complex
BSF r16/32,rm16/32	2	CLTS	complex
BSR r16/32,m16/32	3	CMC	1
BSR r16/32,rm16/32	2	CMOVB/NAE/C r16/32,m16/32	3
BSWAP r32	2	CMOVB/NAE/C r16/32,r16/32	2
BT m16/32, imm8	2	CMOVBE/NA r16/32,m16/32	3
BT m16/32, r16/32	complex	CMOVBE/NA r16/32,r16/32	2

continued

**Table C-1 Pentium II and Pentium III Processors Instruction to Decoder Specification (continued)**

<b>Instruction</b>	<b># of μops</b>	<b>Instruction</b>	<b># of μops</b>
BT rm16/32, imm8	1	CMOVE/Z r16/32,m16/32	3
BT rm16/32, r16/32	1	CMOVE/Z r16/32,r16/32	2
BTC m16/32, imm8	4	CMOVNS r16/32,r16/32	3
BTC m16/32, r16/32	complex	CMOVOr16/32,m16/32	
BTC rm16/32, imm8	1	CMOVOr16/32,r16/32	2
CMOVL/NGE r16/32,m16/32	3	CMOVPE r16/32,m16/32	3
CMOVL/NGE r16/32,r16/32	2	CMOVPE r16/32,r16/32	2
CMOVLE/NG r16/32,m16/32	3	CMOV r16/32,m16/32	3
CMOVLE/NG r16/32,r16/32	2	CMOV r16/32,r16/32	2
CMOVNB/AE/NC r16/32,m16/32	3	CMP AL, imm8	1
CMOVNB/AE/NC r16/32,r16/32	2	CMP eAX,imm16/32	1
CMOVNBE/A r16/32,m16/32	3	CMP m16/32, imm16/32	2
CMOVNBE/A r16/32,r16/32	2	CMP m16/32, imm8	2
CMOVNE/NZ r16/32,m16/32	3	CMP m16/32,r16/32	2
CMOVNE/NZ r16/32,r16/32	2	CMP m8, imm8	2
CMOVNL/GE r16/32,m16/32	3	CMP m8, imm8	2
CMOVNL/GE r16/32,r16/32	2	CMP m8,r8	2
CMOVNLE/G r16/32,m16/32	3	CMP r16/32,m16/32	2
CMOVNLE/G r16/32,r16/32	2	CMP r16/32,rm16/32	1
CMOVNO r16/32,m16/32	3	CMP r8,m8	2
CMOVNO r16/32,r16/32	2	CMP r8,rm8	1
CMOVNP/PO r16/32,m16/32	3	CMP rm16/32,imm16/32	1

continued

**Table C-1 Pentium II and Pentium III Processors Instruction to Decoder Specification (continued)**

<b>Instruction</b>	<b># of μops</b>	<b>Instruction</b>	<b># of μops</b>
CMOVNP/PO r16/32,r16/32	2	CMP rm16/32,imm8	1
CMOVNS r16/32,m16/32	3	CMP rm16/32,r16/32	1
CMP rm8,imm8	1	FADDm32real	2
CMP rm8,imm8	1	FADD m64real	2
CMP rm8,r8	1	FADDP ST(i),ST	1
CMPSB/W/D m8/16/32,m8/16/32	complex	FBLD m80dec	complex
CMPXCHG m16/32,r16/32	complex	FBSTP m80dec	complex
CMPXCHG m8,r8	complex	FCHS	3
CMPXCHG rm16/32,r16/32	complex	FCMOVB STi	2
CMPXCHG rm8,r8	complex	FCMOVBE STi	2
CMPXCHG8B rm64	complex	FCMOVE STi	2
CPUID	complex	FCMOVNB STi	2
CWD/CDQ	1	FCMOVNBE STi	2
CWDE	1	FCMOVNE STi	2
DAA	1	FCMOVNU STi	2
DAS	1	FCMOVU STi	2
DECm16/32	4	FCOM STi	1
DECm8	4	FCOM m32real	2
DECr16/32	1	FCOM m64real	2
DECrm16/32	1	FCOM2 STi	1
DECm8	4	FCOMI STi	1
DIV AL,rm8	3	FCOMIP STi	1
DIV AX,m16/32	4	FCOMP STi	1
DIV AX,m8	4	FCOMP m32real	2
DIV AX,rm16/32	4	FCOMP m64real	2
ENTER	complex	FCOMP3 STi	1

continued



**Table C-1 Pentium II and Pentium III Processors Instruction to Decoder Specification (continued)**

<b>Instruction</b>	<b># of μops</b>	<b>Instruction</b>	<b># of μops</b>
F2XM1	complex	FCOMP5 STi	1
FABS	1	FCOMPP	2
FADD ST(i),ST	1	FCOS	
FADD ST,ST(i)	1	FDECSTP	1
FDISI	1	FINCSTP	1
FDIV ST(i),ST	1	FIST m16int	4
FDIV ST,ST(i)	1	FIST m32int	4
FDIV m32real	2	FISTP m16int	4
FDIV m64real	2	FISTP m32int	4
FDIVP ST(i),ST	1	FISTP m64int	4
FDIVR ST(i),ST	1	FISUB m16int	complex
FDIVR ST,ST(i)	1	FISUB m32int	complex
FDIVR m32real	2	FISUBR m16int	complex
FDIVR m64real	2	FISUBR m32int	complex
FDIVRP ST(i),ST	1	FLD STi	1
FENI	1	FLD m32real	1
FFREE ST(i)	1	FLD m64real	1
FFREEP ST(i)	2	FLD m80real	4
FIADD m16int	complex	FLD1	2
FIADD m32int	complex	FLDCW m2byte	3
FICOM m16int	complex	FLDENV m14/28byte	complex
FICOM m32int	complex	FLDL2E	2
FICOMP m16int	complex	FLDL2T	2
FICOMP m32int	complex	FLDLG2	2
FIDIV m16int	complex	FLDLN2	2
FIDIV m32int	complex	FLDPI	2
FIDIVR m16int	complex	FLDZ	1

continued

**Table C-1 Pentium II and Pentium III Processors Instruction to Decoder Specification (continued)**

<b>Instruction</b>	<b># of μops</b>	<b>Instruction</b>	<b># of μops</b>
FIDIVR m32int	complex	FMUL ST(i),ST	1
FILD m16int	4	FMUL ST,ST(i)	1
FILD m32int	4	FMUL m32real	2
FILD m64int	4	FMUL m64real	2
FIMUL m16int	complex	FMULP ST(i),ST	1
FIMUL m32int	complex	FNCLEX	3
FNINIT	complex	FSUB ST,ST(i)	
FNOP	1	FSUB m32real	2
FNSAVE m94/108byte	complex	FSUB m64real	2
FNSTCW m2byte	3	FSUBP ST(i),ST	1
FNSTENV m14/28byte	complex	FSUBR ST(i),ST	1
FNSTSW AX	3	FSUBR ST,ST(i)	1
FNSTSW m2byte	3	FSUBR m32real	2
FPATAN	complex	FSUBR m64real	2
FPREM	complex	FSUBRP ST(i),ST	1
FPREM1	complex	FTST	1
FPTAN	complex	FUCOM STi	1
FRNDINT	complex	FUCOMI STi	1
FRSTOR m94/108byte	complex	FUCOMIP STi	1
FSCALE	complex	FUCOMP STi	1
FSETPM	1	FUCOMPP	2
FSIN	complex	FWAIT	2
FSINCOS	complex	FXAM	1
FSQRT	1	FXCH STi	1
FST STi	1	FXCH4 STi	1
FST m32real	2	FXCH7 STi	1
FST m64real	2	FXTRACT	complex

continued

**Table C-1 Pentium II and Pentium III Processors Instruction to Decoder Specification (continued)**

<b>Instruction</b>	<b># of μops</b>	<b>Instruction</b>	<b># of μops</b>
FSTP STi	1	FYL2X	complex
FSTP m32real	2	FYL2XP1	complex
FSTP m64real	2	HALT	complex
FSTP m80real	complex	IDIV AL,rm8	3
FSTP1 STi	1	IDIV AX,m16/32	4
FSTP8 STi	1	IDIV AX,m8	4
FSTP9 STi	1	IDIV eAX,rm16/32	4
FSUB ST(i),ST	1	IMUL m16	4
IMUL m32	4	JBE/NA rel8	1
IMUL m8	2	JCXZ/JECXZ rel8	2
IMUL r16/32,m16/32	2	JE/Z rel16/32	1
IMUL r16/32,rm16/32	1	JE/Z rel8	1
IMUL	2	JL/NGE rel16/32	1
r16/32,rm16/32,imm8/16/32			
IMUL	1	JL/NGE rel8	1
r16/32,rm16/32,imm8/16/32			
IMUL rm16	3	JLE/NG rel16/32	1
IMUL rm32	3	JLE/NG rel8	1
IMUL rm8	1	JMP m16	complex
IN eAX, DX	complex	JMP near m16/32	2
IN eAX, imm8	complex	JMP near reg16/32	1
INCM16/32	4	JMP ptr16	complex
INCM8	4	JMP rel16/32	1
INCr16/32	1	JMP rel8	1
INCrM16/32	1	JNB/AE/NC rel16/32	1
INCrM8	1	JNB/AE/NC rel8	1
INSB/W/D m8/16/32,DX	complex	JNBE/A rel16/32	1

continued

**Table C-1 Pentium II and Pentium III Processors Instruction to Decoder Specification (continued)**

<b>Instruction</b>	<b># of μops</b>	<b>Instruction</b>	<b># of μops</b>
INT1	complex	JNBE/A rel8	1
INT3	complex	JNE/NZ rel16/32	1
INTN	3	JNE/NZ rel8	1
INTO	complex	JNL/GE rel16/32	1
INVD	complex	JNL/GE rel8	1
INVLPG m	complex	JNLE/G rel16/32	1
IRET	complex	JNLE/G rel8	1
JB/NAE/C rel16/32	1	JNO rel16/32	1
JB/NAE/C rel8	1	JNO rel8	1
JBE/NA rel16/32	1	JNP/PO rel16/32	1
JNP/PO rel8	1	LOCK ADC m16/32,r16/32	complex
JNS rel16/32	1	LOCK ADC m8,imm8	complex
JNS rel8	1	LOCK ADC m8,r8	complex
JOrel16/32	1	LOCK ADD m16/32,imm16/32	complex
JOrel8	1	LOCK ADD m16/32,r16/32	complex
JP/PE rel16/32	1	LOCK ADD m8,imm8	complex
JP/PE rel8	1	LOCK ADD m8,r8	complex
JS rel16/32	1	LOCK AND m16/32,imm16/32	complex
JS rel8	1	LOCK AND m16/32,r16/32	complex
LAHF	1	LOCK AND m8,imm8	complex
LAR m16	complex	LOCK AND m8,r8	complex
LAR rm16	complex	LOCK BTC m16/32, imm8	complex
LDS r16/32,m16	complex	LOCK BTC m16/32, r16/32	complex
LEA r16/32,m	1	LOCK BTR m16/32, imm8	complex
LEAVE	3	LOCK BTR m16/32, r16/32	complex

continued

**Table C-1 Pentium II and Pentium III Processors Instruction to Decoder Specification (continued)**

<b>Instruction</b>	<b># of μops</b>	<b>Instruction</b>	<b># of μops</b>
LES r16/32,m16	complex	LOCK BTS m16/32, imm8	complex
LFS r16/32,m16	complex	LOCK BTS m16/32, r16/32	complex
LGDT m16&32	complex	LOCK CMPXCHG m16/32,r16/32	complex
LGS r16/32,m16	complex	LOCK CMPXCHG m8,r8	complex
LIDT m16&32	complex	LOCK CMPXCHG8B rm64	complex
LLDT m16	complex	LOCK DECm16/32	complex
LLDT rm16	complex	LOCK DECm8	complex
LMSW m16	complex	LOCK INCm16/32	complex
LMSW r16	complex	LOCK INCm8	complex
LOCK ADC m16/32,imm16/32	complex	LOCK NEGm16/32	complex
LOCK NEGm8	complex	LODSB/W/D m8/16/32,m8/16/32	
LOCK NOTm16/32	complex	LOOP rel8	4
LOCK NOTm8	complex	LOOPE rel8	4
LOCK ORm16/32,imm16/32	complex	LOOPNE rel8	4
LOCK ORm16/32,r16/32	complex	LSL m16	complex
LOCK ORm8,imm8	complex	LSL rm16	complex
LOCK ORm8,r8	complex	LSS r16/32,m16	complex
LOCK SBB m16/32,imm16/32	complex	LTR m16	complex
LOCK SBB m16/32,r16/32	complex	LTR rm16	complex
LOCK SBB m8,imm8	complex	MOV AL,moffs8	1
LOCK SBB m8,r8	complex	MOV CR0, r32	complex

continued

**Table C-1 Pentium II and Pentium III Processors Instruction to Decoder Specification (continued)**

<b>Instruction</b>	<b># of μops</b>	<b>Instruction</b>	<b># of μops</b>
LOCK SUB m16/32,imm16/32	complex	MOV CR2, r32	complex
LOCK SUB m16/32,r16/32	complex	MOV CR3, r32	complex
LOCK SUB m8,imm8	complex	MOV CR4, r32	complex
LOCK SUB m8,r8	complex	MOV DRx, r32	complex
LOCK XADD m16/32,r16/32	complex	MOV DS,m16	4
LOCK XADD m8,r8	complex	MOV DS,rm16	4
LOCK XCHG m16/32,r16/32	complex	MOV ES,m16	4
LOCK XCHG m8,r8	complex	MOV ES,rm16	4
LOCK XOR m16/32,imm16/32	complex	MOV FS,m16	4
LOCK XOR m16/32,r16/32	complex	MOV FS,rm16	4
LOCK XOR m8,imm8	complex	MOV GS,m16	4
LOCK XOR m8,r8	complex	MOV GS,rm16	4
MOV SS,m16	4	MOV rm16,ES	1
MOV SS,rm16	4	MOV rm16,FS	1
MOV eAX,moffs16/32	1	MOV rm16,GS	1
MOV m16,CS	3	MOV rm16,SS	1
MOV m16,DS	3	MOV rm16/32,imm16/32	1
MOV m16,ES	3	MOV rm16/32,r16/32	1
MOV m16,FS	3	MOV rm8,imm8	1
MOV m16,GS	3	MOV rm8,r8	1
MOV m16,SS	3	MOVSB/W/D m8/16/32,m8/16/32	complex
MOV m16/32,imm16/32	2	MOVSB r16,m8	1
MOV m16/32,r16/32	2	MOVSB r16,rm8	1

continued

**Table C-1 Pentium II and Pentium III Processors Instruction to Decoder Specification (continued)**

<b>Instruction</b>	<b># of μops</b>	<b>Instruction</b>	<b># of μops</b>
MOV m8,imm8	2	MOVSB r16/32,m16	1
MOV m8,r8	2	MOVSB r32,m8	1
MOV moffs16/32,eAX	2	MOVSB r32,rm16	1
MOV moffs8,AL	2	MOVSB r32,rm8	1
MOV r16/32,imm16/32	1	MOVZB r16,m8	1
MOV r16/32,m16/32	1	MOVZB r16,rm8	1
MOV r16/32,rm16/32	1	MOVZB r32,m16	1
MOV r32, CR0	complex	MOVZB r32,m8	1
MOV r32, CR2	complex	MOVZB r32,rm16	1
MOV r32, CR3	complex	MOVZB r32,rm8	1
MOV r32, CR4	complex	MUL AL,m8	2
MOV r32, DRx	complex	MUL AL,rm8	1
MOV r8,imm8	1	MUL AX,m16	4
MOV r8,m8	1	MUL AX,rm16	3
MOV r8,rm8	1	MUL EAX,m32	4
MOV rm16,CS	1	MUL EAX,rm32	3
MOV rm16,DS	1	NEGm16/32	4
NEGm8	4	POP GS	complex
NEGrm16/32	1	POP SS	complex
NEGrm8	1	POP eSP	3
NOP	1	POP m16/32	complex
NOTm16/32	4	POP r16/32	2
NOTm8	4	POP r16/32	2
NOTrm16/32	1	POPA/POPAD	complex
NOTrm8	1	POPF	complex
ORAL,imm8	1	POPFD	complex
OReAX,imm16/32	1	PUSH CS	4

continued

**Table C-1 Pentium II and Pentium III Processors Instruction to Decoder Specification (continued)**

<b>Instruction</b>	<b># of μops</b>	<b>Instruction</b>	<b># of μops</b>
ORm16/32,imm16/32	4	PUSH DS	4
ORm16/32,r16/32	4	PUSH ES	4
ORm8,imm8	4	PUSH FS	4
ORm8,r8	4	PUSH GS	4
ORr16/32,imm16/32	1	PUSH SS	4
ORr16/32,imm8	1	PUSH imm16/32	3
ORr16/32,m16/32	2	PUSH imm8	3
ORr16/32,rm16/32	1	PUSH m16/32	4
ORr8,imm8	1	PUSH r16/32	3
ORr8,m8	2	PUSH r16/32	3
ORr8,rm8	1	PUSHA/PUSHAD	complex
ORrm16/32,r16/32	1	PUSHF/PUSHFD	complex
ORrm8,r8	1	RCL m16/32,1	4
OUT DX, eAX	complex	RCL m16/32,CL	complex
OUT imm8, eAX	complex	RCL m16/32,imm8	complex
OUTSB/W/D DX,m8/16/32	complex	RCL m8,1	4
POP DS	complex	RCL m8,CL	complex
POP ES	complex	RCL m8,imm8	complex
POP FS	complex	RCL rm16/32,1	2
RCL rm16/32,CL	complex	REP LODSB/W/D m8/16/32,m8/16/32	complex
RCL rm16/32,imm8	complex	REP MOVSB/W/D m8/16/32,m8/16/32	complex
RCL rm8,1	2	REP OUTSB/W/D DX,m8/16/32	complex

continued



**Table C-1 Pentium II and Pentium III Processors Instruction to Decoder Specification (continued)**

<b>Instruction</b>	<b># of μops</b>	<b>Instruction</b>	<b># of μops</b>
RCL rm8,CL	complex	REP SCASB/W/D m8/16/32,m8/16/32	complex
RCL rm8,imm8	complex	REP STOSB/W/D m8/16/32,m8/16/32	complex
RCR m16/32,1	4	RET	4
RCR m16/32,CL	complex	RET	complex
RCR m16/32,imm8	complex	RET near	4
RCR m8,1	4	RET near iw	complex
RCR m8,CL	complex	ROL m16/32,1	4
RCR m8,imm8	complex	ROL m16/32,CL	4
RCR rm16/32,1	2	ROL m16/32,imm8	4
RCR rm16/32,CL	complex	ROL m8,1	4
RCR rm16/32,imm8	complex	ROL m8,CL	4
RCR rm8,1	2	ROL m8,imm8	4
RCR rm8,CL	complex	ROL rm16/32,1	1
RCR rm8,imm8	complex	ROL rm16/32,CL	1
RDMSR	complex	ROL rm16/32,imm8	1
RDPMC	complex	ROL rm8,1	1
RDTSC	complex	ROL rm8,CL	1
REP CMPSB/W/D m8/16/32,m8/16/32	complex	ROL rm8,imm8	1
REP INSB/W/D m8/16/32,DX	complex	ROR m16/32,1	4
ROR m16/32,CL	4	SBB m16/32,r16/32	4
ROR m16/32,imm8	4	SBB m8,imm8	4
ROR m8,1	4	SBB m8,r8	4
ROR m8,CL	4	SBB r16/32,imm16/32	2

continued

**Table C-1 Pentium II and Pentium III Processors Instruction to Decoder Specification (continued)**

<b>Instruction</b>	<b># of μops</b>	<b>Instruction</b>	<b># of μops</b>
ROR m8,imm8	4	SBB r16/32,m16/32	3
ROR rm16/32,1	1	SBB r16/32,rm16/32	2
ROR rm16/32,CL	1	SBB r8,imm8	2
ROR rm16/32,imm8	1	SBB r8,m8	3
ROR rm8,1	1	SBB r8,rm8	2
ROR rm8,CL	1	SBB rm16/32,r16/32	2
ROR rm8,imm8	1	SBB rm8,r8	2
RSM	complex	SCASB/W/D	3
		m8/16/32,m8/16/32	
SAHF	1	SETB/NAE/C m8	3
SAR m16/32,1	4	SETB/NAE/C rm8	1
SAR m16/32,CL	4	SETBE/NA m8	3
SAR m16/32,imm8	4	SETBE/NA rm8	1
SAR m8,1	4	SETE/Z m8	3
SAR m8,CL	4	SETE/Z rm8	1
SAR m8,imm8	4	SETL/NGE m8	3
SAR rm16/32,1	1	SETL/NGE rm8	1
SAR rm16/32,CL	1	SETLE/NG m8	3
SAR rm16/32,imm8	1	SETLE/NG rm8	1
SAR rm8,1	1	SETNB/AE/NC m8	3
SAR rm8,CL	1	SETNB/AE/NC rm8	1
SAR rm8,imm8	1	SETNBE/A m8	3
SBB AL,imm8	2	SETNBE/A rm8	1
SBB eAX,imm16/32	2	SETNE/NZ m8	3
SBB m16/32,imm16/32	4	SETNE/NZ rm8	1
SETNL/GE m8	3	SHL/SAL rm16/32,1	1
SETNL/GE rm8	1	SHL/SAL rm16/32,1	1

continued

**Table C-1 Pentium II and Pentium III Processors Instruction to Decoder Specification (continued)**

<b>Instruction</b>	<b># of μops</b>	<b>Instruction</b>	<b># of μops</b>
SETNLE/G m8	3	SHL/SAL rm16/32,CL	1
SETNLE/G rm8	1	SHL/SAL rm16/32,CL	1
SETNO m8	3	SHL/SAL rm16/32,imm8	1
SETNO rm8	1	SHL/SAL rm16/32,imm8	1
SETNP/PO m8	3	SHL/SAL rm8,1	1
SETNP/PO rm8	1	SHL/SAL rm8,1	1
SETNS m8	3	SHL/SAL rm8,CL	1
SETNS rm8	1	SHL/SAL rm8,CL	1
SETOm8	3	SHL/SAL rm8,imm8	1
SETOrm8	1	SHL/SAL rm8,imm8	1
SETP/PE m8	3	SHLD m16/32,r16/32,CL	4
SETP/PE rm8	1	SHLD m16/32,r16/32,imm8	4
SETS m8	3	SHLD rm16/32,r16/32,CL	2
SETS rm8	1	SHLD rm16/32,r16/32,imm8	2
SGDT m16&32	4	SHR m16/32,1	4
SHL/SAL m16/32,1	4	SHR m16/32,CL	4
SHL/SAL m16/32,1	4	SHR m16/32,imm8	4
SHL/SAL m16/32,CL	4	SHR m8,1	4
SHL/SAL m16/32,CL	4	SHR m8,CL	4
SHL/SAL m16/32,imm8	4	SHR m8,imm8	4
SHL/SAL m16/32,imm8	4	SHR rm16/32,1	1
SHL/SAL m8,1	4	SHR rm16/32,CL	1
SHL/SAL m8,1	4	SHR rm16/32,imm8	1
SHL/SAL m8,CL	4	SHR rm8,1	1
SHL/SAL m8,CL	4	SHR rm8,CL	1
SHL/SAL m8,imm8	4	SHR rm8,imm8	1
SHL/SAL m8,imm8	4	SHRD m16/32,r16/32,CL	4

continued

**Table C-1 Pentium II and Pentium III Processors Instruction to Decoder Specification (continued)**

Instruction	# of $\mu$ ops	Instruction	# of $\mu$ ops
SHRD m16/32,r16/32,imm8	4	SUB rm16/32,r16/32	1
SHRD rm16/32,r16/32,CL	2	SUB rm8,r8	1
SHRD rm16/32,r16/32,imm8	2	TEST AL,imm8	1
SIDT m16&32	complex	TEST eAX,imm16/32	1
SLDT m16	complex	TEST m16/32,imm16/32	2
SLDT rm16	4	TEST m16/32,imm16/32	2
SMSW m16	complex	TEST m16/32,r16/32	2
SMSW rm16	4	TEST m8,imm8	2
STC	1	TEST m8,imm8	2
STD	4	TEST m8,r8	2
STI	complex	TEST rm16/32,imm16/32	1
STOSB/W/D m8/16/32,m8/16/32	3	TEST rm16/32,r16/32	1
STR m16	complex	TEST rm8,imm8	1
STR rm16	4	TEST rm8,r8	1
SUB AL,imm8	1	VERR m16	complex
SUB eAX,imm16/32	1	VERR rm16	complex
SUB m16/32,imm16/32	4	VERW m16	complex
SUB m16/32,r16/32	4	VERW rm16	complex
SUB m8,imm8	4	WBINVD	complex
SUB m8,r8	4	WRMSR	complex
SUB r16/32,imm16/32	1	XADD m16/32,r16/32	complex
SUB r16/32,imm8	1	XADD m8,r8	complex
SUB r16/32,m16/32	2	XADD rm16/32,r16/32	4
SUB r16/32,rm16/32	1	XADD rm8,r8	4
SUB r8,imm8	1	XCHG eAX,r16/32	3

continued

**Table C-1 Pentium II and Pentium III Processors Instruction to Decoder Specification (continued)**

<b>Instruction</b>	<b># of μops</b>	<b>Instruction</b>	<b># of μops</b>
SUB r8,m8	2	XCHG m16/32,r16/32	complex
SUB r8,rm8	1	XCHG m8,r8	complex
XCHG rm16/32,r16/32	3	XOR r16/32,imm16/32	
XCHG rm8,r8	3	XOR r16/32,imm8	
XLAT/B	2	XOR r16/32,m16/32	
XOR AL,imm8	1	XOR r16/32,rm16/32	
XOR eAX,imm16/32	1	XOR r8,imm8	
XOR m16/32,imm16/32	4	XOR r8,m8	
XOR m16/32,r16/32	4	XOR r8,rm8	
XOR m8,imm8	4	XOR rm16/32,r16/32	
XOR m8,r8	4	XOR rm8,r8	

**Table C-2 MMX Technology Instruction to Decoder Specification**

<b>Instruction</b>	<b># of μops</b>	<b>Instruction</b>	<b># of μops</b>
EMMS	complex	PADDB mm,m64	2
MOVD m32,mm	2	PADDB mm,mm	1
MOVD mm,ireg	1	PADDD mm,m64	2
MOVD mm,m32	1	PADDD mm,mm	1
MOVQ mm,m64	1	PADDSB mm,m64	2
MOVQ mm,mm	1	PADDSB mm,mm	1
MOVQ m64,mm	2	PADDSW mm,m64	2
MOVQ mm,mm	1	PADDSW mm,mm	1
PACKSSDW mm,m64	2	PADDUSB mm,m64	2
PACKSSDW mm,mm	1	PADDUSB mm,mm	1
PACKSSWB mm,m64	2	PADDUSW mm,m64	2
PACKSSWB mm,mm	1	PADDUSW mm,mm	1

continued

**Table C-2 MMX Technology Instruction to Decoder Specification (continued)**

<b>Instruction</b>	<b># of <math>\mu</math>ops</b>	<b>Instruction</b>	<b># of <math>\mu</math>ops</b>
PACKUSWB mm,m64	2	PADDW mm,m64	2
PACKUSWB mm,mm	1	PADDW mm,mm	1
PAND mm,m64	2	PSLLQ mm,mm	1
PAND mm,mm	1	PSLLW mm,m64	2
PANDN mm,m64	2	PSLLW mm,mm	1
PANDN mm,mm	1	PSRAD mm,m64	2
PCMPEQB mm,m64	2	PSRAD mm,mm	1
PCMPEQB mm,mm	1	PSRAimmD mm,imm8	1
PCMPEQD mm,m64	2	PSRAimmW mm,imm8	1
PCMPEQD mm,mm	1	PSRAW mm,m64	2
PCMPEQW mm,m64	2	PSRAW mm,mm	1
PCMPEQW mm,mm	1	PSRLD mm,m64	2
PCMPGTB mm,m64	2	PSRLD mm,mm	1
PCMPGTB mm,mm	1	PSRLimmD mm,imm8	1
PCMPGTD mm,m64	2	PSRLimmQ mm,imm8	1
PCMPGTD mm,mm	1	PSRLimmW mm,imm8	1
PCMPGTW mm,m64	2	PSRLQ mm,m64	2
PCMPGTW mm,mm	1	PSRLQ mm,mm	1
PMADDWD mm,m64	2	PSRLW mm,m64	2
PMADDWD mm,mm	1	PSRLW mm,mm	1
PMULHW mm,m64	2	PSUBB mm,m64	2
PMULHW mm,mm	1	PSUBB mm,mm	1
PMULLW mm,m64	2	PSUBD mm,m64	2
PMULLW mm,mm	1	PSUBD mm,mm	1
POR mm,m64	2	PSUBSB mm,m64	2
POR mm,mm	1	PSUBSB mm,mm	1
PSLLD mm,m64	2	PSUBSW mm,m64	2
PSLLD mm,mm	1	PSUBSW mm,mm	1
PSLLimmD mm,imm8	1	PSUBUSB mm,m64	2

continued

**Table C-2 MMX Technology Instruction to Decoder Specification (continued)**

<b>Instruction</b>	<b># of <math>\mu</math>ops</b>	<b>Instruction</b>	<b># of <math>\mu</math>ops</b>
PSLLimmQ mm,imm8	1	PSUBUSB mm,mm	1
PSLLimmW mm,imm8	1	PSUBUSW mm,m64	2
PSLLQ mm,m64	2	PSUBUSW mm,mm	1
PSUBW mm,m64	2	PUNPCKLBW mm,m32	2
PSUBW mm,mm	1	PUNPCKLBW mm,mm	1
PUNPCKHBW mm,m64	2	PUNPCKLDQ mm,m32	2
PUNPCKHBW mm,mm	1	PUNPCKLDQ mm,mm	1
PUNPCKHDQ mm,m64	2	PUNPCKLWD mm,m32	2
PUNPCKHDQ mm,mm	1	PUNPCKLWD mm,mm	1
PUNPCKHWD mm,m64	2	PXOR mm,m64	2
PUNPCKHWD mm,mm	1	PXOR mm,mm	1





# Streaming SIMD Extensions Throughput and Latency



This appendix presents Table D-1 which lists for each Streaming SIMD Extension the execution port(s), execution unit(s), the latency number of cycles and the throughput.

**Table D-1 Streaming SIMD Extensions Throughput and Latency**

Instruction	Ports	Units	Latency	Throughput
ADDPS/ SUBPS/	Port 1	PFADDER	4 cycles	1 every 2 cycles
CVTSS2SS	Port 1,2	PFADDER/ PSHUF,MIU/	4 cycles	1 every 2 cycles
CVTPI2PS/ CVTPS2PI	Port 1	PFADDER	3 cycles	1 every cycle
MAXPS/MINPS	Port 1	PFADDER	4 cycles	1 every 2 cycles
CMPPS	Port 1	PFADDER	4 cycles	1 every 2 cycles
ADDSS/SUBSS/	Port 1	PFADDER	3 cycles	1 every cycle
CVTSS2SI/ CVTSS2SI	Port 1,2	PFADDER, MIU	3 cycles	1 every cycle
MAXSS/MINSS	Port 1	PFADDER	3 cycles	1 every cycle
CMPSS	Port 1	PFADDER	3 cycles	1 every cycle
COMISS/ UCOMISS	Port 1	PFADDER	1 cycle	1 every cycle
MULPS	Port 0	PFMULT	5 cycles	1 every 2 cycles
DIVPS/SQRTPS	Port 0	PFMULT	36/58 cycles	1 every 36/58 cycles
MULSS	Port 0	PFMULT	4 cycles	1 every cycle

continued

**Table D-1 Streaming SIMD Extensions Throughput and Latency (continued)**

<b>Instruction</b>	<b>Ports</b>	<b>Units</b>	<b>Latency</b>	<b>Throughput</b>
DIVSS/SQRTSS	Port 0	PFMULT	18/30 cycles	1 every 18/29 cycles
RCPPS/ RCQRTPS	Port 1	PFROM	2 cycles	1 every 2 cycles
SHUPPS/	Port 1	PFSHUF	2 cycles	1 every 2 cycles
UNPCKHPS/ UNPCKLPS	Port 1	PFSHUF	3 cycles	1 every 2 cycles
MOVAPS	load: 2 mov: 0 or 1 store: 3 and 4	MIU FWU,PFSHUF MIU	load: 4 mov: 1 store: 4	1 every 2 cycles 1 every 1 cycle 1 every 2 cycles
MOVUPS	load: 2 store: 3 and 4	MIU	4 cycles 5 cycles	1 every 2 cycles 1 every 3 cycles
MOVHPS/ MOVLPS	load: 2 store: 3 and 4	MIU	3 cycles	1 every cycle
MOVMSKPS	Port 0	WIRE	1 cycle	1 every cycle
MOVSS	Port 0,1	FP, PFSHF	1 cycle	1 every cycle
ANDPS/ORPS/ XORPS	Port 1	PFSHUFF	2 cycles	1 every 2 cycles
PMOVMSKB	Port 1	WIRE	1 cycle	1 every cycle
PSHUFW/ PEXTRW	Port 1	PFSHUFF	1 cycle 2 cycles	1 every cycle 1 every 2 cycles
PINSRW/(reg, mem)	Port 1	PFSHUFF	4 cycles	1 every cycle
PSADW	Port 0,1	SIMD	5 cycles	1 every 2 cycles
PMINUB PMINSW PMAXUB PMAXSW	Port 0,1	SIMD	1 cycle	1 every 1/2 cycle
PMULHUW	Port 0	SIMD	3 cycles	1 every cycle
MOVNTPS	Port 3,4	MIU, DCU	4 cycles	1 every 2 cycles
MOVNTQ	Port 3,4	MIU, DCU	3 cycles	1 every cycle
PREFETCH*/	Port 2	AGU/memory cluster	2 cycles	1 every cycle
FXRESTOR/ FXSAVE		MICORCODE		

continued

**Table D-1 Streaming SIMD Extensions Throughput and Latency (continued)**

<b>Instruction</b>	<b>Ports</b>	<b>Units</b>	<b>Latency</b>	<b>Throughput</b>
LDMXCSR/ STMXCSR		MICORCODE		
MASKMOVQ/	Port 0,1,3,4	AGU, MIU, FWU	4 cycles	1 every cycle
SFENCE	Port 3,4	AGU, MIU	3 cycles	1 every cycle
PAVGB PAVGW	Port 0,1	SIMD	1 cycle	1 every 1/2 cycle



# *Stack Alignment for Streaming SIMD Extensions*

---



This appendix details on the alignment of the stacks of data for Streaming SIMD Extensions.

## **Stack Frames**

This section describes the stack alignment conventions for both `esp`-based (normal), and `ebp`-based (debug) stack frames. A stack frame is a contiguous block of memory allocated to a function for its local memory needs. It contains space for the function's parameters, return address, local variables, register spills, parameters needing to be passed to other functions that a stack frame may call, and possibly others. It is typically delineated in memory by a stack frame pointer (`esp`) that points to the base of the frame for the function and from which all data are referenced via appropriate offsets. The convention on IA-32 is to use the `esp` register as the stack frame pointer for normal optimized code, and to use `ebp` in place of `esp` when debug information must be kept. Debuggers use the `ebp` register to find the information about the function via the stack frame.

It is important to ensure that the stack frame is aligned to a 16-byte boundary upon function entry to keep local `__m128` data, parameters, and `xmm` register spill locations aligned throughout a function invocation. The Intel C/C++ Compiler for Win32\* Systems supports conventions presented here help to prevent memory references from incurring penalties due to misaligned data by keeping them aligned to 16-byte boundaries. In addition, this scheme supports improved alignment for `__m64` and `double` type data by enforcing that these 64-bit data items are at least eight-byte aligned (they will now be 16-byte aligned).

For variables allocated in the stack frame, the compiler cannot guarantee the base of the variable is aligned unless it also ensures that the stack frame itself is 16-byte aligned. Previous IA-32 software conventions, as implemented in most compilers, only ensure that individual stack frames are 4-byte aligned. Therefore, a function called from a Microsoft\*-compiled function, for example, can only assume that the frame pointer it used is 4-byte aligned.

Earlier versions of the Intel C/C++ Compiler for Win32 Systems have attempted to provide 8-byte aligned stack frames by dynamically adjusting the stack frame pointer in the prologue of `main` and preserving 8-byte alignment of the functions it compiles. This technique is limited in its applicability for the following reasons:

- The `main` function must be compiled by the Intel C/C++ Compiler.
- There may be no functions in the call tree compiled by some other compiler (as might be the case for routines registered as callbacks).
- Support is not provided for proper alignment of parameters.

The solution to this problem is to have the function's entry point assume only 4-byte alignment. If the function has a need for 8-byte or 16-byte alignment, then code can be inserted to dynamically align the stack appropriately, resulting in one of the stack frames shown in Figure E-1.

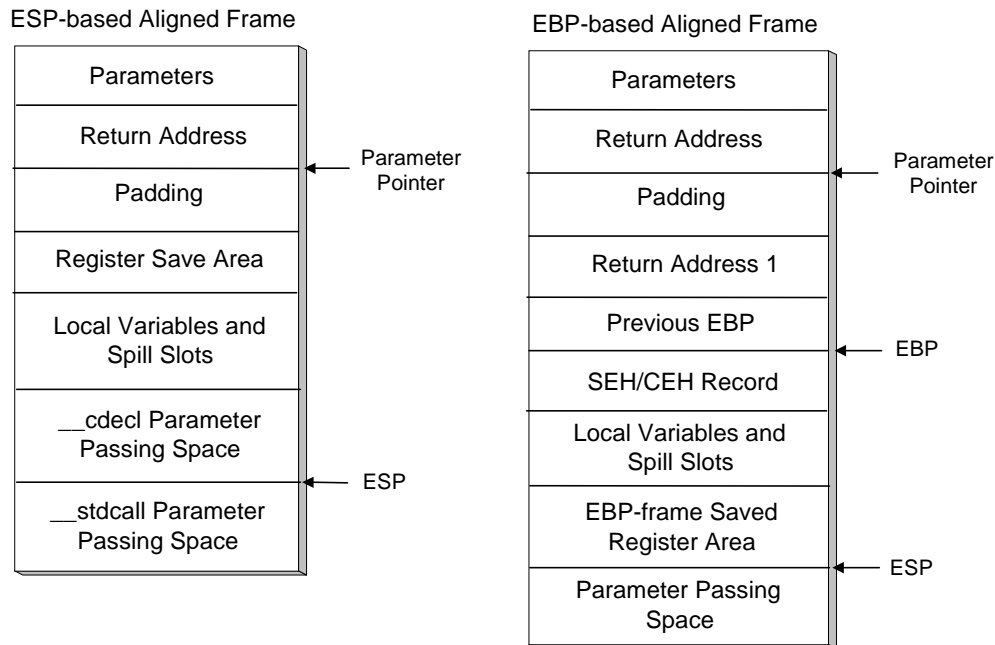
**Figure E-1 Stack Frames Based on Alignment Type**

As an optimization, an alternate entry point can be created that can be called when proper stack alignment is provided by the caller. Using call graph profiling of the VTune™ analyzer, calls to the normal (unaligned) entry point can be optimized into calls to the (alternate) aligned entry point when the stack can be proven to be properly aligned. Furthermore, a function alignment requirement attribute can be modified throughout the call graph so as to cause the least number of calls to unaligned entry points. As an example of this, suppose function F has only a stack alignment requirement of 4, but it calls function G at many call sites, and in a loop. If G's alignment requirement is 16, then by promoting F's alignment requirement to 16, and making all calls to G go to its aligned entry point, the compiler can minimize the number of times that control passes through the unaligned

entry points. Example E-1 and Example E-2 in the following sections illustrate this technique. Note the entry points `foo` and `foo.aligned`, the latter is the alternate aligned entry point.

## Aligned `esp`-Based Stack Frames

This section discusses data and parameter alignment and the `declspec(align)` extended attribute, which can be used to request alignment in C and C++ code. In creating `esp`-based stack frames, the compiler adds padding between the return address and the register save area as shown in Example 3-9. This frame can be used only when debug information is not requested, there is no need for exception handling support, inlined assembly is not used, and there are no calls to `alloca` within the function.

If the above conditions are not met, an aligned `ebp`-based frame must be used. When using this type of frame, the sum of the sizes of the return address, saved registers, local variables, register spill slots, and parameter space must be a multiple of 16 bytes. This causes the base of the parameter space to be 16-byte aligned. In addition, any space reserved for passing parameters for `stdcall` functions also must be a multiple of 16 bytes. This means that the caller needs to clean up some of the stack space when the size of the parameters pushed for a call to a `stdcall` function is not a multiple of 16. If the caller does not do this, the stack pointer is not restored to its pre-call value.

In Example E-1, we have 12 bytes on the stack after the point of alignment from the caller: the return pointer, `ebx` and `edx`. Thus, we need to add four more to the stack pointer to achieve alignment. Assuming 16 bytes of stack space are needed for local variables, the compiler adds  $16 + 4 = 20$  bytes to `esp`, making `esp` aligned to a 0 mod 16 address.



---

**Example E-1 Aligned esp-Based Stack Frames**

---

```
void _cdecl foo (int k)
{
    int j;
    foo:                                // See Note A
        push    ebx
        mov     ebx, esp
        sub     esp, 0x00000008
        and     esp, 0xffffffff0
        add     esp, 0x00000008
        jmp     common
foo.aligned:
        push    ebx
        mov     ebx, esp

        common:                          // See Note B
            push    edx
            sub     esp, 20
j = k;
        mov     edx, [ebx + 8]
        mov     [esp + 16], edx
foo(5);
        mov     [esp], 5
        call   foo.aligned
return j;
        mov     eax, [esp + 16]
        add     esp, 20
        pop     edx
        mov     esp, ebx
        pop     ebx
        ret
```

---



---

**NOTE.** *A. Aligned entry points assume that parameter block beginnings are aligned. This places the stack pointer at a 12 mod 16 boundary, as the return pointer has been pushed. Thus, the unaligned entry point must force the stack pointer to this boundary.*

*B. The code at the common label assumes the stack is at an 8 mod 16 boundary, and adds sufficient space to the stack so that the stack pointer is aligned to a 0 mod 16 boundary.*

---

## Aligned `ebp`-Based Stack Frames

In `ebp`-based frames, padding is also inserted immediately before the return address. However, this frame is slightly unusual in that the return address may actually reside in two different places in the stack. This occurs whenever padding must be added and exception handling is in effect for the function. Example E-2 shows the code generated for this type of frame. The stack location of the return address is aligned 12 mod 16. This means that the value of `ebp` always satisfies the condition `(ebp & 0x0f) == 0x08`. In this case, the sum of the sizes of the return address, the previous `ebp`, the exception handling record, the local variables, and the spill area must be a multiple of 16 bytes. In addition, the parameter passing space must be a multiple of 16 bytes. For a call to a `stdcall` function, it is necessary for the caller to reserve some stack space if the size of the parameter block being pushed is not a multiple of 16.

### Example E-2 Aligned `ebp`-based Stack Frames

---

```
void _stdcall foo (int k)
{
    int j;
foo:
    push    ebx
    mov     ebx, esp
    sub     esp, 0x00000008
    and     esp, 0xffffffff0
```

---

continued

**Example E-2 Aligned ebp-based Stack Frames (continued)**

```

        add     esp, 0x00000008 // esp is (8 mod 16)
                                // after add
        jmp     common
foo.aligned:
        push   ebx              // esp is (8 mod 16)
                                // after push
        mov    ebx, esp
common:
        push   ebp              // this slot will be
                                // used for duplicate
                                // return pt

push    ebp                    // esp is (0 mod 16)
                                // after push
                                // (rtn,ebx,ebp,ebp)
        mov    ebp, [ebx + 4]    // fetch return pointer
and store
        mov    [esp + 4], ebp    // relative to ebp
                                // (rtn,ebx,rtn,ebp)
        mov    ebp, esp         // ebp is (0 mod 16)
        sub    esp, 28          // esp is (4 mod 16)
                                // see Note A

        push   edx              // esp is (0 mod 16)
                                // after push
                                // the goal is to make
                                // esp and ebp (0 mod
                                // 16) here

j = k;
        mov    edx, [ebx + 8]    // k is (0 mod 16) if
                                // caller aligned
                                // his stack
        mov    [ebp - 16], edx   // J is (0 mod 16)
foo(5);
        add    esp, -4           // normal call sequence
                                // to unaligned entry
        mov    [esp], 5

```

continued

## Example E-2 Aligned ebp-based Stack Frames (continued)

---

```
        call    foo                // for stdcall, callee
                                        // cleans up stack
foo.aligned(5);
        add     esp,-16            // aligned entry, this
                                        // should be a
                                        // multiple of 16

        mov     [esp],5
        call   foo.aligned
        add     esp,12            // see Note B
return j;

        mov     eax,[ebp-16]
        pop     edx
        mov     esp,ebp
        pop     ebp
        mov     esp,ebx
        pop     ebx
        ret     4
}
```

---



**NOTE. A.** Here we allow for local variables. However, this value should be adjusted so that, after pushing the saved registers,  $esp$  is  $0 \bmod 16$ .

**B.** Just prior to the call,  $esp$  is  $0 \bmod 16$ . To maintain alignment,  $esp$  should be adjusted by 16. When a callee uses the `stdcall` calling sequence, the stack pointer is restored by the callee. The final addition of 12 compensates for the fact that only 4 bytes were passed, rather than 16, and thus the caller must account for the remaining adjustment.

---

## Stack Frame Optimizations

The Intel C/C++ Compiler provides certain optimizations that may improve the way aligned frames are set up and used. These optimizations are as follows:

- If a procedure is defined to leave the stack frame 16-byte-aligned and it calls another procedure that requires 16-byte alignment, then the callee's aligned entry point is called, bypassing all of the unnecessary aligning code.
- If a static function requires 16-byte alignment, and it can be proven to be called only by other functions that require 16-byte alignment, then that function will not have any alignment code in it. That is, the compiler will not use `ebx` to point to the argument block and it will not have alternate entry points, because this function will never be entered with an unaligned frame.

## Inlined Assembly and `ebx`

When using aligned frames, the `ebx` register generally should not be modified in inlined assembly blocks since `ebx` is used to keep track of the argument block. Programmers may modify `ebx` only if they do not need to access the arguments and provided they save `ebx` and restore it before the end of the function (since `esp` is restored relative to `ebx` in the function's epilog).

For additional information on the use of `ebx` in inline assembly code and other related issues, see the Intel application note AP-833, *Data Alignment and Programming Issues with the Intel C/C++ Compiler*, order number 243872, and AP-589, *Software Conventions for the Streaming SIMD Extensions*, order number 243873.



---

**CAUTION.** Do not use the `ebx` register in inline assembly functions that use dynamic stack alignment for `double`, `__m64`, and `__m128` local variables unless you save and restore `ebx` each time you use it. The Intel C/C++ Compiler uses the `ebx` register to control alignment of variables of these types, so the use of `ebx`, without preserving it, will cause unexpected program execution.

---



# The Mathematics of Prefetch Scheduling Distance



This appendix discusses how far away to insert prefetch instructions. It presents a mathematical model allowing you to deduce a simplified equation which you can use for determining the prefetch scheduling distance (PSD) for your application.

For your convenience, the first section presents this simplified equation; the second section provides the background for this equation: the mathematical model of the calculation.

## Simplified Equation

A simplified equation to compute PSD is as follows:

$$psd = \left| \frac{Nlookup + Nxfer \cdot (N_{pref} + N_{st})}{CPI \cdot N_{inst}} \right|$$

where

- psd* is prefetch scheduling distance.
- Nlookup* is the number of clocks for lookup latency. This parameter is system-dependent. The type of memory used and the chipset implementation affect its value.
- Nxfer* is the number of clocks to transfer a cache-line. This parameter is implementation-dependent.
- N<sub>pref</sub>* and *N<sub>st</sub>* are the numbers of cache lines to be prefetched and stored.

*CPI* is the number of clocks per instruction. This parameter is implementation-dependent.

*N<sub>inst</sub>* is the number of instructions in the scope of one loop iteration.

Consider the following example of a heuristic equation assuming that parameters have the values as indicated:

$$psd = \left\lceil \frac{60 + 25 \cdot (N_{pref} + N_{st})}{1.5 \cdot N_{inst}} \right\rceil$$

where 60 corresponds to *N<sub>lookup</sub>*, 25 to *N<sub>xfer</sub>*, and 1.5 to *CPI*.

The values of the parameters in the equation can be derived from the documentation for memory components and chipsets as well as from vendor datasheets.



---

**CAUTION.** *The values in this example are for illustration only and do not represent the actual values for these parameters. The example is provided as a “starting point approximation” of calculating the prefetch scheduling distance using the above formula. Experimenting with the instruction around the “starting point approximation” may be required to achieve the best possible performance.*

---

## Mathematical Model for PSD

The parameters used in the mathematics discussed are as follows:

*psd* prefetch scheduling distance (measured in number of iterations)

*il* iteration latency

*T<sub>c</sub>* computation latency per iteration with prefetch caches

*T<sub>l</sub>* memory leadoff latency including cache miss latency, chip set latency, bus arbitration, etc.



$T_b$  data transfer latency which is equal to number of lines per iteration \* line burst latency

Note that the potential effects of  $\mu\text{op}$  reordering are not factored into the estimations discussed.

Examine Example F-1 that uses the `prefetchnta` instruction with a prefetch scheduling distance of 3, that is,  $\text{psd} = 3$ . The data prefetched in iteration  $i$ , will actually be used in iteration  $i+3$ .  $T_c$  represents the cycles needed to execute `top_loop` - assuming all the memory accesses hit L1 while  $il$  (iteration latency) represents the cycles needed to execute this loop with actually run-time memory footprint.  $T_c$  can be determined by computing the critical path latency of the code dependency graph. This work is quite arduous without help from special performance characterization tools or compilers. A simple heuristic for estimating the  $T_c$  value is to count the number of instructions in the critical path and multiply the number with an artificial CPI. A reasonable CPI value would be somewhere between 1.0 and 1.5 depending on the quality of code scheduling.

### Example F-1 Calculating Insertion for Scheduling Distance of 3

---

```

top_loop:
    prefetchnta [edx+esi+32*3]
    prefetchnta [edx*4+esi+32*3]
    . . . . .
    movaps xmm1, [edx+esi]
    movaps xmm2, [edx*4+esi]
    movaps xmm3, [edx+esi+16]
    movaps xmm4, [edx*4+esi+16]
    . . . . .
    . . .
    add esi, 32
    cmp esi, ecx
    jl top_loop
    
```

---

Memory access plays a pivotal role in prefetch scheduling. For more understanding of a memory subsystem, consider a Streaming SIMD Extensions memory pipeline depicted in Figure F-1.

**Figure F-1 Pentium® II and Pentium III Processors Memory Pipeline Sketch**

---

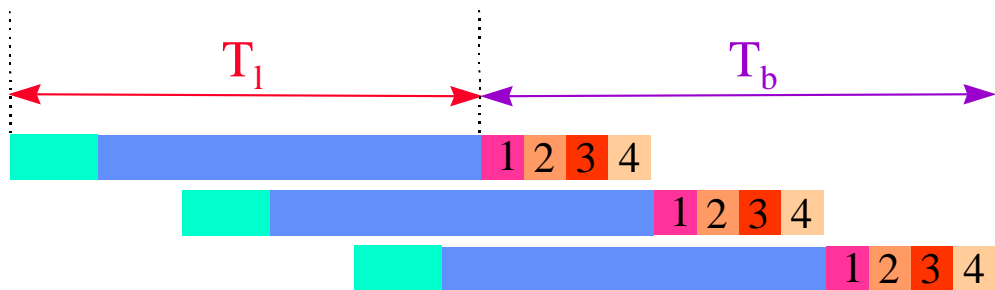

- : L2 lookup miss latency
- : Memory page access leadoff latency
- : Latency for 4 chunks returned per line

---

Assume that three cache lines are accessed per iteration and four chunks of data are returned per iteration for each cache line. Also assume these 3 accesses are pipelined in memory subsystem. Based on these assumptions,

$$T_b = 3 * 4 = 12 \text{ FSB cycles.}$$

$T_1$  varies dynamically and is also system hardware-dependent. The static variants include the core-to-front-side-bus ratio, memory manufacturer and memory controller (chipset). The dynamic variants include the memory page open/miss occasions, memory accesses sequence, different memory types, and so on.

To determine the proper prefetch scheduling distance, follow these steps and formulae:

- Optimize  $T_c$  as much as possible
- Use the following set of formulae to calculate the proper prefetch scheduling distance:

$$\begin{array}{lll}
 T_c \geq T_l + T_b & psd = 1 & il = T_c \\
 T_l + T_b > T_c > T_b & psd = \left\lceil \frac{T_l + T_b}{T_c} \right\rceil & il = T_c \\
 T_b \geq T_c & psd = 1 + \left\lceil \frac{T_l}{T_b} \right\rceil & il = T_b
 \end{array}$$

- Schedule the prefetch instructions according to the computed prefetch scheduling distance.
- For optimized memory performance, apply techniques described in [“Memory Optimization Using Prefetch” in Chapter 6](#).

The following sections explain and illustrate the architectural considerations involved in the prefetch scheduling distance formulae above.

## No Preloading or Prefetch

The traditional programming approach does not perform data preloading or prefetch. It is sequential in nature and will experience stalls because the memory is unable to provide the data immediately when the execution pipeline requires it. Examine Figure F-2.

**Figure F-2 Execution Pipeline, No Preloading or Prefetch**

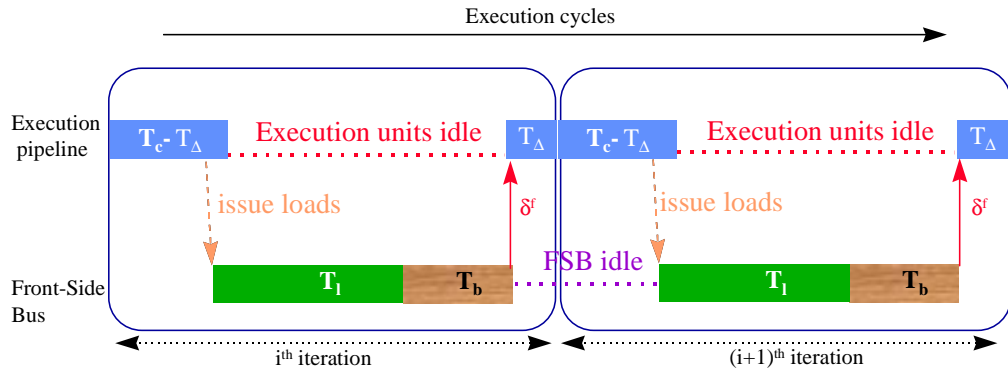

As you can see from Figure F-2, the execution pipeline is stalled while waiting for data to be returned from memory. On the other hand, the front side bus is idle during the computation portion of the loop. The memory access latencies could be hidden behind execution if data could be fetched earlier during the bus idle time.

Further analyzing Figure 6-10,

- assume execution cannot continue till last chunk returned and
- $\delta^f$  indicates flow data dependency that stalls the execution pipelines

With these two things in mind the iteration latency ( $il$ ) is computed as follows:

$$il \equiv T_c + T_l + T_b$$

The iteration latency is approximately equal to the computation latency plus the memory leadoff latency (includes cache miss latency, chipset latency, bus arbitration, and so on.) plus the data transfer latency where

transfer latency = number of lines per iteration \* line burst latency.

This means that the decoupled memory and execution are ineffective to explore the parallelism because of flow dependency. That is the case where prefetch can be useful by removing the bubbles in either the execution pipeline or the memory pipeline.

With an ideal placement of the data prefetching, the iteration latency should be either bound by execution latency or memory latency, that is

$$il = \text{maximum}(T_c, T_b).$$

### Compute Bound (Case: $T_c \geq T_l + T_b$ )

Figure F-3 represents the case when the compute latency is greater than or equal to the memory leadoff latency plus the data transfer latency. In this case, the prefetch scheduling distance is exactly 1, i.e. prefetch data one iteration ahead is good enough. The data for loop iteration  $i$  can be prefetched during loop iteration  $i-1$ , the  $\delta^f$  symbol between front-side bus and execution pipeline indicates the data flow dependency.

**Figure F-3** Compute Bound Execution Pipeline

---

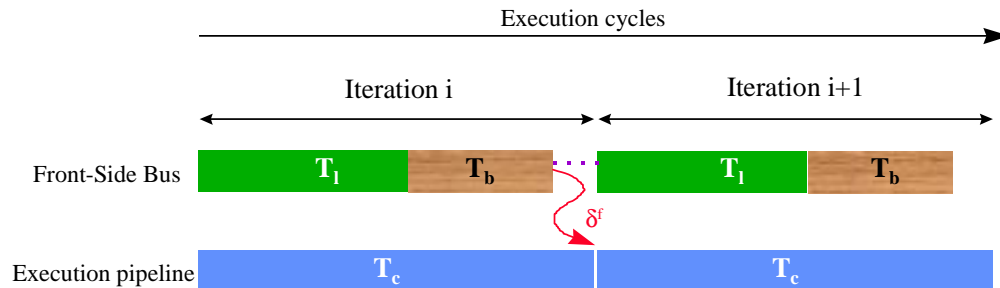

The following formula shows the relationship among the parameters:

$$psd = \left\lceil \frac{T_l + T_b}{T_c} \right\rceil = 1 \quad il = T_c$$

It can be seen from this relationship that the iteration latency is equal to the computation latency, which means the memory accesses are executed in background and their latencies are completely hidden.

## Compute Bound (Case: $T_1 + T_b > T_c > T_b$ )

Now consider the next case by first examining Figure F-4.

**Figure F-4 Compute Bound Execution Pipeline**

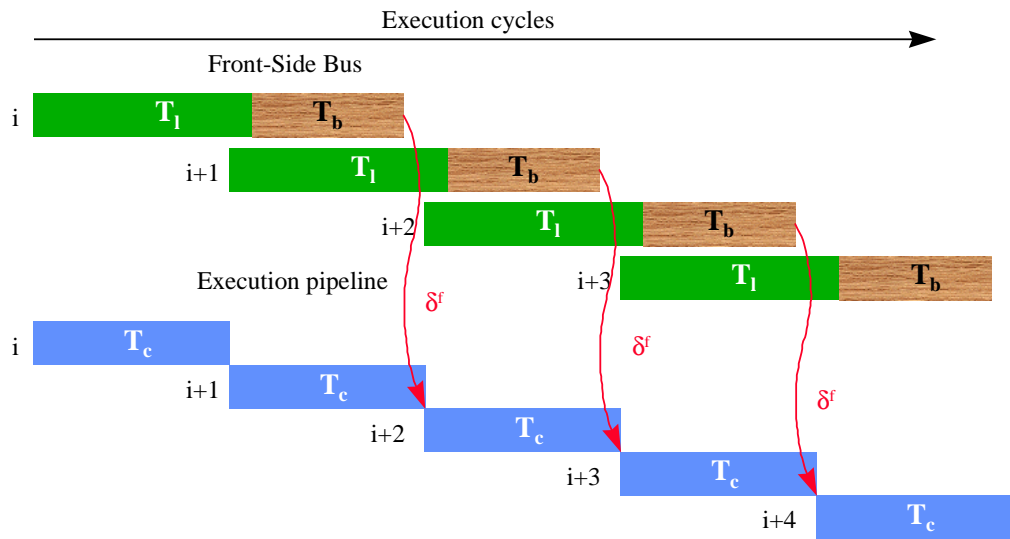

For this particular example the prefetch scheduling distance is greater than 1. Data being prefetched for iteration  $i$  will be consumed in iteration  $i+2$ . Figure 6-12 represents the case when the leadoff latency plus data transfer latency is greater than the compute latency, which is greater than the data transfer latency. The following relationship can be used to compute the prefetch scheduling distance.

$$psd = \left\lceil \frac{T_i + T_b}{T_c} \right\rceil > 1 \quad \text{if } T_c = T_c$$

In consequence, the iteration latency is also equal to the computation latency, that is, compute bound program.

### Memory Throughput Bound (Case: $T_b \geq T_c$ )

When the application or loop is memory throughput bound, the memory latency is no way to be hidden. Under such circumstances, the burst latency is always greater than the compute latency. Examine Figure F-5.

**Figure F-5** Memory Throughput Bound Pipeline

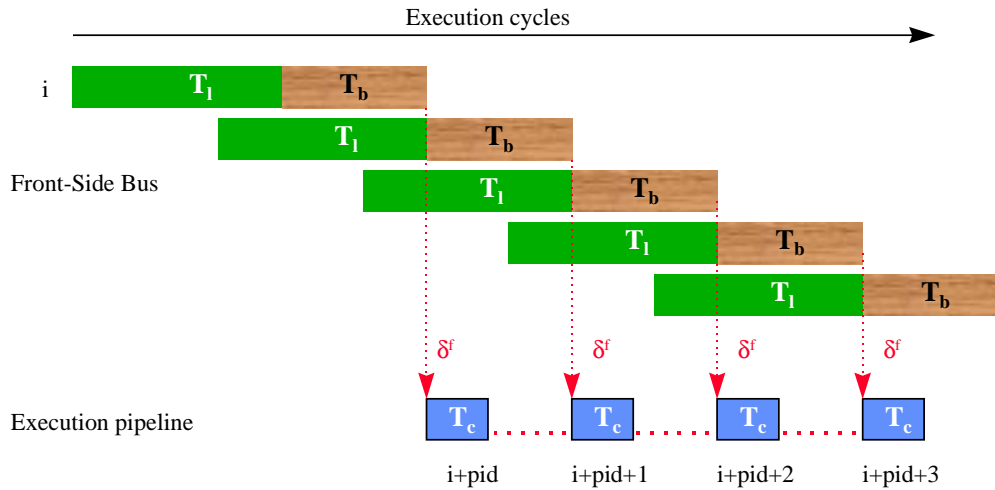

The following relationship calculates the prefetch scheduling distance (or prefetch iteration distance) for the case when memory throughput latency is greater than the compute latency.

$$psd = \left\lceil \frac{T_i + T_b}{T_b} \right\rceil = 1 + \left\lceil \frac{T_i}{T_b} \right\rceil > 1 \quad \text{if } T_i = T_b$$

Apparently, the iteration latency is dominant by the memory throughput and you cannot do much about it. Typically, data copy from one space to another space, for example, graphics driver moving data from writeback memory to you cannot do much about it. Typically, data copy from one space to another space, for example, graphics driver moving data from writeback memory to write-combining memory, belongs to this category, where performance advantage from prefetch instructions will be marginal.

## Example

As an example of the previous cases consider the following conditions for computation latency and the memory throughput latencies. Assume  $T_l = 18$  and  $T_b = 8$  (in front side bus cycles).

$$\text{if } T_c \geq 26 \Rightarrow psd = \left\lceil \frac{18+8}{T_c} \right\rceil = 1$$

$$\text{if } 26 > T_c > 8 \Rightarrow 2 \leq psd = \left\lceil \frac{18+8}{T_c} \right\rceil \leq 3$$

$$\text{if } T_c \leq 8 \Rightarrow psd = 1 + \left\lceil \frac{18}{8} \right\rceil = 4$$

Now for the case  $T_l=18$ ,  $T_b=8$  (2 cache lines are needed per iteration) examine the following graph. Consider the graph of accesses per iteration in example 1, Figure F-6.



Figure F-6 Accesses per Iteration, Example 1

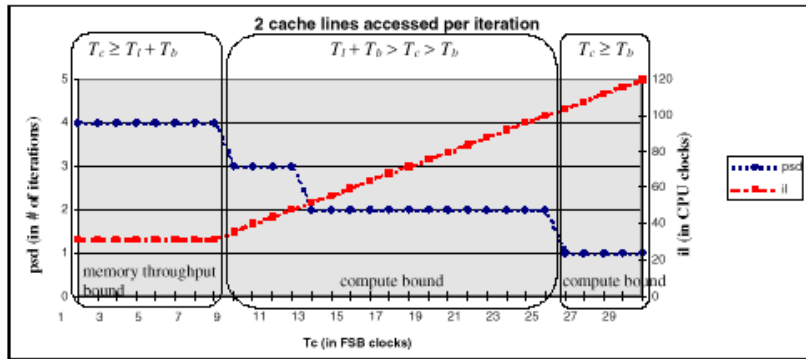

The prefetch scheduling distance is a step function of  $T_c$ , the computation latency. The steady state iteration latency ( $il$ ) is either memory-bound or compute-bound depending on  $T_c$  if prefetches are scheduled effectively.

The graph in example 2 of accesses per iteration in Figure F-7 shows the results for prefetching multiple cache lines per iteration. The cases shown are for 2, 4, and 6 cache lines per iteration, resulting in differing burst latencies. ( $T_f=18, T_b=8, 16, 24$ ).

**Figure F-7 Accesses per Iteration, Example 2**

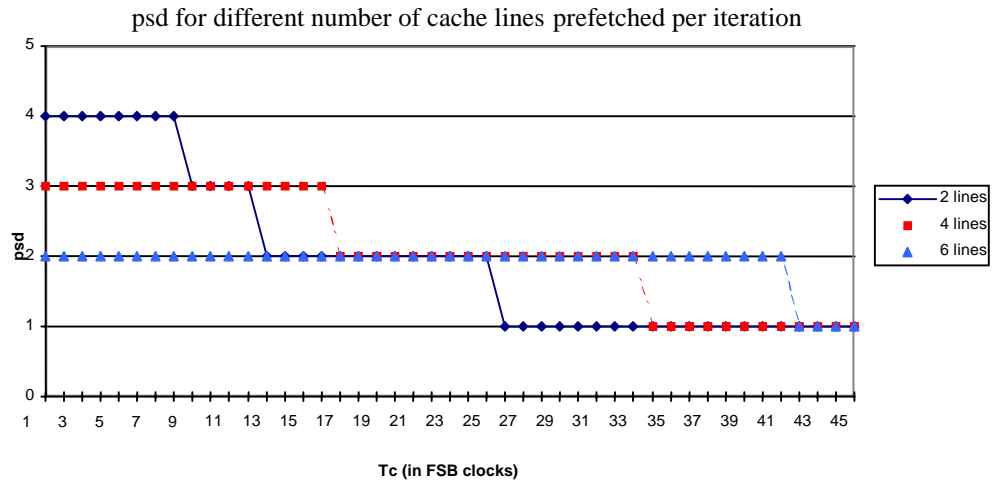

In reality, the front-side bus (FSB) pipelining depth is limited, that is, only four transactions are allowed at a time in the Pentium® III processor. Hence a transaction bubble or gap,  $T_g$ , (gap due to idle bus of imperfect front side bus pipelining) will be observed on FSB activities. This leads to consideration of the transaction gap in computing the prefetch scheduling distance. The transaction gap,  $T_g$ , must be factored into the burst cycles,  $T_b$ , for the calculation of prefetch scheduling distance.

The following relationship shows computation of the transaction gap.

$$T_g = \max(T_l - c * (n - 1), 0)$$

where  $T_l$  is the memory leadoff latency,  $c$  is the number of chunks per cache line and  $n$  is the FSB pipelining depth.

# Index

---

3D transformation algorithms, A-7  
4-1-1 order, 1-5

## A

---

absolute difference, A-15  
  of signed numbers, 4-15  
  of unsigned numbers, 4-14  
absolute value, 4-17  
accesses per iteration, F-11, F-12  
address alignment, 2-2  
address calculations, 2-19  
advancing memory loads, A-19  
aligned ebp-based frame, E-4, E-6  
aligned esp-based stack frames, E-4  
alignment, 2-11  
  coe, 2-11  
  data, 2-12  
  rules, 2-11  
AoS format, 3-21, A-8  
AoS. See array of structures  
application performance tools, 7-1  
arithmetic logic unit, 1-9  
array of structures, A-8  
assembly coach, 7-13  
assembly coach techniques, 7-13  
assembly code for SoA transformation, A-13

automatic masked exception handling, 5-38  
automatic processor dispatch support, 7-15  
automatic vectorization, 3-13, 3-14

## B

---

blending of code, 2-10  
branch misprediction ratio, 2-8  
Branch Prediction, 1-5, 2-1, 2-2  
branch target buffer, 1-5  
BTB misses, 7-10  
BTB. See branch target buffer

## C

---

cache blocking techniques, 6-18  
cache hierarchy, 7-6  
cache level, 6-2  
cache management  
  simple memory copy, 6-28  
  video decoder, 6-27  
  video encoder, 6-27  
cache misses, 2-2  
cache performance, 7-5  
cacheability control instructions, 6-9  
calculating insertion for scheduling distance, F-3  
call graph profiling, 7-7

- Call Graph view, 7-7
  - call information, 7-9
  - changing the rounding mode, 2-26
  - checking for MMX technology support, 3-2
  - checking for Streaming SIMD Extensions support, 3-3
  - child function, 7-9
  - classes (C/C++), 3-12
  - clearing registers, 2-19
  - clipping to an arbitrary signed range, 4-17
  - clipping to an arbitrary unsigned range, 4-19
  - code coach, 7-11, 7-13
  - code optimization advice, 7-11, 7-13
  - code optimization options, 7-14
  - coding methodologies, 3-8
  - coding techniques, 3-7
    - absolute difference of signed numbers, 4-15
    - absolute difference of unsigned numbers, 4-14
    - absolute value, 4-17
    - clipping to an arbitrary signed range, 4-17
    - clipping to an arbitrary unsigned range, 4-19
    - generating constants, 4-20
    - interleaved pack with saturation, 4-9
    - interleaved pack without saturation, 4-11
    - non-interleaved unpack, 4-12
    - signed unpack, 4-8
    - simplified clipping to an arbitrary signed range, 4-19
    - unsigned unpack, 4-8
  - coherent requests, 6-8
  - command-line options, 7-14
    - automatic processor dispatch support, 7-15
    - floating-point arithmetic precision, 7-17
    - inline expansion of library functions, 7-17
    - loop unrolling, 7-17
    - prefetching, 7-16
    - rounding control, 7-17
    - targeting a processor, 7-15
    - vectorizer switch, 7-16
  - comparing register values, 2-19
  - compiler intrinsics
    - `_mm_load`, 6-26
    - `_mm_prefetch`, 6-26
    - `_mm_stream`, 6-26
  - compiler plug-in, 7-14
  - compiler-supported alignment, 3-18
  - complex FIR filter, A-21
  - complex FIR filter algorithm
    - reducing non-value-added instructions, A-21
    - unrolling the loop, A-21
    - using a SIMD data structure, A-21
  - complex instructions, 1-4, 2-17
  - computation latency, F-8
  - computation-intensive code, 3-7
  - compute bound, F-7, F-8
  - conditional branches, 1-7, 2-5
  - conditional moves emulation, 5-31
  - converting code to MMX technology, 3-4
  - counters, 7-6
  - CPUID instruction, 3-2
  - CPUID usage, 4-2, 5-5
- ## D
- data alignment, 3-15, 5-5
  - data arrangement, 5-6
  - data cache unit, 2-12
  - data copy, F-10
  - data deswizzling, 5-13, 5-15
  - data swizzling, 5-10
  - data swizzling using intrinsics, 5-11
  - DCU. See data cache unit
  - debug symbols, 7-9
  - decoder, 2-15
  - decoder specifications, C-1
  - decoders, 1-4
  - decoupled memory, F-7
  - dependency chains, A-9

divide instructions, 2-20  
dynamic assembly analysis, 7-10  
dynamic branch prediction, 2-2, 2-3  
dynamic prediction, 1-6

## **E**

---

EBS. See event-based sampling  
eight-bit operands, 2-18  
eliminating branches, 2-5, 2-7, 2-8  
eliminating unnecessary micro-ops, A-20  
EMMS instruction, 4-3, 4-5, 4-6, 5-4  
EMMS schedule, 5-27  
epilog sequences, 2-20  
event-based sampling, 7-4  
executing instructions out-of-order, 5-28  
execution unit, D-1  
extract word instruction, 4-22

## **F**

---

FIR filter algorithm, A-17  
    advancing memory loads, A-19  
    minimizing cache pollution on write, A-20  
    minimizing pointer arithmetic, A-20  
    parallel multiplications, A-17  
    prefetch hints, A-20  
    reducing data dependency, A-17  
    reducing register pressure, A-17  
    scheduling for the reoder buffer, A-18  
    separating memory accesses from  
        operations, A-19  
    unrolling the loop, A-19  
    wrapping the loop around, A-18  
fist instruction, 2-25  
fldcw instruction, 2-26  
floating-point applications, 2-20  
floating-point arithmetic precision options, 7-17

floating-point code  
    improving parallelism, 2-21  
    loop unrolling, 2-28  
    memory access stall information, 2-24  
    operations with integer operands, 2-30  
    optimizing, 2-21  
    transcendental functions, 2-31  
floating-point execution unit, 1-9  
floating-point operations with integer operands,  
    2-30  
floating-point stalls, 2-29  
flow dependency, 6-4, F-7  
flush to zero, 5-42  
forwarding from stores to loads, 5-31  
front-end pipeline, 1-4  
fstsw instruction, 2-31  
FXCH instruction, 2-23

## **G**

---

general optimization techniques, 2-1  
    branch prediction, 2-2  
    dynamic branch prediction, 2-2  
    eliminate branches, 2-6  
    eliminating branches, 2-5  
    static prediction, 2-3  
generating constants, 4-20

## **H**

---

hiding one-clock latency, 2-29  
horizontal computations, 5-18  
hotspots, 3-6, 7-10, 7-11

## **I**

---

incorporating prefetch into code, 6-23  
increasing bandwidth of memory fills, 4-32  
increasing bandwidth of video fills, 4-32

indirect branch, 2-5  
inline assembly, 4-5  
inline expansion of library functions option, 7-17  
inlined assembly blocks, E-9  
inlined-asm, 3-10  
in-order issue front end, 1-2  
in-order retirement, 1-3  
insert word instruction, 4-22  
instruction fetch unit, 1-5  
instruction prefetch, 2-3  
instruction prefetcher, 1-4  
instruction scheduling, 4-34  
instruction selection, 2-16  
integer and floating-point multiply, 2-30  
integer divide, 2-20  
integer-intensive application, 4-1, 4-2  
Intel Performance Library Suite, 7-1  
interaction with x87 numeric exceptions, 5-41  
interleaved pack with saturation, 4-9  
interleaved pack without saturation, 4-11  
interprocedural optimization, 7-17  
IPO. See interprocedural optimization

## **L**

---

large load stalls, 2-25  
latency, 1-3, 2-29, 6-1  
latency number of cycles, D-1  
lea instruction, 2-17  
loading and storing to and from the same DRAM page, 4-32  
loop blocking, 3-25  
loop unrolling, 2-28  
loop unrolling option, 7-17  
loop unrolling. See unrolling the loop.

## **M**

---

macro-instruction, 2-14  
memory access stall information, 2-24  
memory bank conflicts, 6-25  
memory O=optimization U=using P=prefetch, 6-10  
memory optimization, 4-27  
memory optimizations  
  loading and storing to and from the same DRAM page, 4-32  
  partial memory accesses, 4-28  
  using aligned stores, 4-33  
memory performance, 3-20  
memory reference instructions, 2-19  
memory throughput bound, F-9  
micro-ops, 1-2  
minimize cache pollution on write, A-20  
minimizing cache pollution, 6-5  
minimizing pointer arithmetic, A-20  
minimizing prefetches number, 6-15  
misaligned accesses event, 2-13  
misaligned data, 2-12  
misaligned data access, 3-15  
misalignment in the FIR filter, 3-16  
mispredicted branches, 1-6  
missed cache access, 7-10  
mixing MMX technology code and floating-point code, 5-3  
mixing SIMD-integer and SIMD-fp instructions, 4-6  
modulo 16 branch, 1-4  
modulo scheduling, 5-25  
motion estimation algorithm, A-14  
motion-error calculation, A-15  
move byte mask to integer, 4-24  
movntps instruction, A-20  
MOVQ Instruction, 4-32  
multiply instruction, 2-17

## **N**

---

- new SIMD-integer instructions, 4-21
  - extract word, 4-22
  - insert word, 4-22
  - move byte mask to integer, 4-24
  - packed average byte or word), 4-27
  - packed multiply high unsigned, 4-25
  - packed shuffle word, 4-25
  - packed signed integer word maximum, 4-23
  - packed signed integer word minimum, 4-23
  - packed sum of absolute differences, 4-26
  - packed unsigned integer byte maximum, 4-23
  - packed unsigned integer byte minimum, 4-24
- Newton-Raphson
  - approximation, A-9
  - formula, A-2
  - iterations, 5-2, A-2
- Newton-Raphson method, A-2, A-3
  - inverse reciprocal approximation, A-5
  - reciprocal instructions, A-2
  - reciprocal square root operation, A-3
- non-coherent requests, 6-8
- non-interleaved unpack, 4-12
- non-temporal store instructions, 6-5
- non-temporal stores, 6-25
- numeric exceptions, 5-36
  - automatic masked exception handling, 5-38
  - conditions, 5-36
  - flush to zero, 5-42
  - interaction with x87, 5-41
  - priority, 5-37
  - unmasked exceptions, 5-39
- O**

---

  - optimization of upsampling algorithm, A-16
  - optimized algorithms, A-1
    - 3D Transformation, A-7
    - FIR filter, A-17
    - motion estimation, A-14
  - Newton-Raphson method with the reciprocal instructions, A-2
  - upsampling signals, A-15
  - optimizing cache utilization
    - cache management, 6-26
    - examples, 6-6
    - non-temporal store instructions, 6-5
    - prefetch and load, 6-4
    - prefetch Instructions, 6-3
    - prefetching, 6-3
    - SFENCE instruction, 6-6
    - streaming, non-temporal stores, 6-6
  - optimizing floating-point applications
    - benefits from SIMD-fp instructions, 5-3
    - conditional moves, 5-31
    - copying, shuffling, 5-17
    - CPUID usage, 5-5
    - data alignment, 5-5
    - data arrangement, 5-6
    - data deswizzling, 5-13
    - data swizzling, 5-10
    - data swizzling using intrinsics, 5-11
    - EMMS instruction, 5-4
    - horizontal ADD, 5-18
    - modulo scheduling, 5-25
    - overlapping iterations, 5-27
    - planning considerations, 5-2
    - port balancing, 5-33
    - rules and suggestions, 5-1
    - scalar code, 5-3
    - schedule with the triple/quadruple rule, 5-24
    - scheduling avoid RAT stalls, 5-31
    - scheduling instructions, 5-22
    - scheduling instructions out-of-order, 5-28
    - vertical versus horizontal computation, 5-6
  - optimizing floating-point code, 2-21
  - out-of-order core, 1-2, 1-3
  - overlapping iterations, 5-27
- P**

---

  - pack instruction, 4-11

- pack instructions, 4-9
- packed average byte or word), 4-27
- packed multiply high unsigned, 4-25
- packed shuffle word, 4-25
- packed signed integer word maximum, 4-23
- packed signed integer word minimum, 4-23
- packed sum of absolute differences, 4-26
- packed unsigned integer byte maximum, 4-23
- packed unsigned integer byte minimum, 4-24
- pairing, 7-9
- parallel multiplications, A-17
- parallelism, 1-7, 3-7, F-7
- parameter alignment, E-4
- parent function, 7-9
- partial memory accesses, 4-28
- partial register stalls, 2-1, 2-8
- PAVGB instruction, 4-27
- PAVGW instruction, 4-27
- penalties, 7-9
- performance counter events, 7-4
- Performance Library Suite, 7-18
  - architecture, 7-19
  - Image Processing Library, 7-19
  - Image Processing Primitives, 7-19
  - Math Kernel Library, 7-19
  - optimizations, 7-20
  - Recognition Primitives Library, 7-18
  - Signal Processing Library, 7-18
- performance-monitoring counters, B-1
- performance-monitoring events, B-2
- PEXTRW instruction, 4-22
- PGO. See profile-guided optimization
- PINSRW instruction, 4-22
- PLS. See Performance Library Suite
- PMINSW instruction, 4-23
- PMINUB instruction, 4-24
- PMOVMSKB instruction, 4-24
- PMULHUW instruction, 4-25
- port balancing, 5-31, 5-33
- predictable memory access patterns, 6-4
- prefetch, 1-4
- prefetch and cacheability Instructions, 6-2
- prefetch and loadiInstructions, 6-4
- prefetch concatenation, 6-13, 6-14
- prefetch hints, A-20
- prefetch instruction, 6-1, A-8, A-15
- prefetch instruction considerations, 6-12
  - cache blocking techniques, 6-18
  - concatenation, 6-13
  - memory bank conflicts, 6-25
  - minimizing prefetches number, 6-15
  - no preloading or prefetch, F-5
  - prefetch scheduling distance, F-5
  - scheduling distance, 6-12
  - single-pass execution, 6-23
  - single-pass vs. multi-pass, 6-24
  - spread prefetch with computatin instructions, 6-16
  - strip-mining, 6-21
- prefetch instructions, 6-4
- prefetch scheduling distance, 6-12, F-5, F-7, F-9
- prefetch use
  - flow dependency, 6-4
  - predictable memory access patterns, 6-4
  - time-consuming innermost loops, 6-4
- prefetching, 7-16, A-9, A-15
- prefetching concept, 6-2
- prefetchnta instruction, 6-20
- prefixed opcodes, 2-2, 2-16
- profile-guided optimization, 7-18
- prolog sequences, 2-20
- PSADBW instruction, 4-26
- psadbw instruction, A-14
- PSHUF instruction, 4-25

## R

- reciprocal instructions, 5-2



- reducing data dependency, A-17
- reducing non-value-added instructions, A-21
- reducing register pressure, A-17
- register viewing tool, 7-2, 7-21
  - register data, 7-21
- return stack buffer, 1-6
- rounding control option, 7-17
- RVT. See register viewing tool

## S

---

- sampling, 7-2
  - event-based, 7-4
  - time-based, 7-3
- scheduling for the reorder buffer, A-18
- scheduling for the reservation station, A-18
- scheduling instructions, 5-22
- scheduling to avoid RAT stalls, 5-31
- scheduling with the triple-quadruple rule, 5-24
- separating memory accesses from operations, A-19
- SFENCE Instruction, 6-6
- short opcodes, 2-17
- signed unpack, 4-8
- SIMD instruction port assignments, 4-7
- SIMD integer code, 4-1
- SIMD. See single-instruction, multiple data.
- SIMD-floating-point code, 5-1
- simple instructions, 1-4
- simple memory copy, 6-28
- simplified 3D geometry pipeline, 6-10
- simplified clipping to an arbitrary signed range, 4-19
- single-instruction, multiple-data, 3-1
- single-pass versus multi-pass execution, 6-23
- smoothed upsample algorithm, A-15
- SoA format, 3-21, A-8
- SoA. See structure of arrays.

- software pipelining, A-18
- software write-combining, 6-25
- spread prefetch, 6-17
- Spreadsheet, 7-7
- stack alignment, 3-16
- stack frame, E-2
- stack frame optimization, E-9
- stall condition, B-1
- static assembly analyzer, 7-10
- static branch prediction algorithm, 2-4
- static code analysis, 7-9
- static prediction, 1-6, 2-3
- static prediction algorithm, 2-3
- streaming non-temporal stores, 6-6
- streaming stores, 6-28
  - approach A, 6-7
  - approach B, 6-7
  - coherent requests, 6-8
  - non-coherent requests, 6-8
- strip-mining, 3-23, 3-25, 6-21, 6-22
- structure of arrays, A-8
- sum of absolute differences, A-15
- swizzling data. See data swizzling.

## T

---

- targeting a processor option, 7-15
- TBS. See time-based sampling
- throughput, 1-3, D-1
- time-based sampling, 7-2, 7-3
- time-consuming innermost loops, 6-4
- TLB. See transaction lookaside buffer
- transaction lookaside buffer, 6-28
- transcendental functions, 2-31
- transfer latency, F-7, F-8
- transposed format, 3-21
- transposing, 3-21

triple-quadruple rule, 5-24  
tuning application, 7-2

## **U**

---

unconditional branch, 2-5  
unmasked exceptions, 5-39  
unpack instructions, 4-12  
unrolling the loop, A-19, A-21  
unsigned unpack, 4-8  
upsampling, A-15  
using aligned stores, 4-33  
using MMX code for copy or shuffling functions,  
5-17

## **V**

---

vector class library, 3-12  
vectorization, 3-7

vectorized code, 3-13  
vectorizer switch options, 7-16  
vertical versus horizontal computation, 5-6  
View by Call Sites, 7-7, 7-9  
VTune analyzer, 2-10, 3-6, 7-1  
VTune Performance Analyzer, 3-6

## **W**

---

wrapping the loop around, A-18  
write-combining buffer, 6-26  
write-combining memory, 6-26